

2
0
2
3

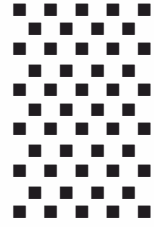

LIVING
LIGHT



GENERAL
CATALOGUE



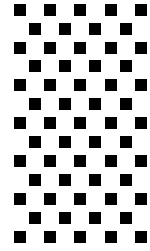

WE DESIGN OUR PRODUCTS
WITH PASSION, TECHNICAL SKILL
AND ATTENTION TO DETAIL,
THINKING OF THE PEOPLE WHO
LIVE OUR LIGHT EVERY DAY.

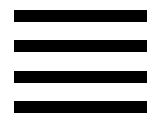

CONTENTS

PRODUCTS INDEX 4

ALPHABETICAL ORDER INDEX 7

NEW PRODUCTS 8

INTRODUCTION 10

PRODUCTS

CONTINUOUS ROW 13

SUSPENDED / CEILING 79

RECESSED 113

DOWNLIGHT 129

TRACK SYSTEMS 177

SPOTLIGHT 187

LOW VOLTAGE 205

WALL / FLOOR 227

INDUSTRIAL IP 251















MEDICAL 275

EMERGENCY 287









OUTDOOR IP 291

LIGHT MANAGEMENT 333





CONTINUOUS ROWS

-  14
ETER
ID 62
-  17
ARKEON
ID 46
-  28
BRIGHT
ID 80
-  33
GROOVE
ID 43
-  38
PHORMA
ID 89
-  44
SEMPLICE
LED
ID 67
-  47
DIAMANTE
ID 82
-  50
VECTOR
ID 84
-  55
ENDO
ID 55
-  61
PROFREEL
ID 83
-  65
PROFREEL
SLIM
ID 83
-  67
FLEX
STRIP LED
ID 83
-  71
WAVE
DISPLAY
ID 85
-  73
OVVIO
DISPLAY LED
ID 40
-  76
GROOVE
DISPLAY
ID 43













SUSPENDED / CEILING

-  80
ONE RING
ID 17
-  84
BEN
ID 10
-  91
PIPE LINE
ID 86
-  94
PIPE LINE
MONO
ID 86
-  96
JOOLES
ID 11
-  98
STYLEO
ID 88
-  100
WAVE
ID 85
-  102
DIMPLES
ID 48
-  109
LITE
ID 47



RECESSED

-  114
ABSENT
ESSENTIAL
ID 41
-  116
LITE
ID 47
-  119
DIMPLES
ID 48
-  121
FLIP
ID 42
-  124
BEN
ID 10

DOWNLIGHT

-  130
MAKE
ID 39
-  138
MAKE Q
ID 39
-  143
MAKE R
ID 39
-  147
TERES MICRO
ZOOM RECESSED
ID 14
-  150
HALL LED
DEEP
ID 38
-  152
CUBE MINI
ID 49
-  155
BOX LED
ID 44
-  158
HALL
LED PRO
ID 38
-  161
HALL LED
ESSENTIAL
ID 38
-  163
OTELLO LED
ID 45
-  166
NEXT
ID 50
-  171
HALL LED
CEILING EVO
ID 28
-  175
HALL LED
ESSENTIAL CEILING
ID 28

TRACK SYSTEMS

-  178
EUROSTANDARD
TRACK
ID 15
-  184
LV TRACK
ID 15

SPOTLIGHT

-  188
TERES
ID 14
-  195
TERES
EXTE
ID 14
-  200
Q1
ID 19

PRODUCTS INDEX

LOW VOLTAGE



206
GHOSTFEED
ID 15



209
NEXT DK LV
ID 50



211
BEN LV
ID 10



213
TERES
MICRO ZOOM
ID 14



215
TERES LV
ID 14



217
LUDO
SPOT
ID 20



219
LUDO
LINEAR 2.0
ID 20



221
LUDO
LINEAR DK
ID 20



223
JOOLS LV
ID 11



225
STYLO LV
ID 88

WALL / FLOOR



228
TOIK
ID 56



230
MONOD
ID 53



239
UPLIK
ID 76



247
ARKEON
WALL
ID 46



249
BEN
ID 10

INDUSTRIAL IP



252
ERGO
ID 02



256
ERGO
ESSENTIAL
ID 02



259
LINEA
IP54
ID 12



262
PCM EVO
ID 03



264
STILLA
ID 05



268
GROOVE
IP54
ID 43



271
GROOVE
DISPLAY IP54
ID 43

MEDICAL



276
ISIB LED
IP54
ID 34



278
ISIL LED
IP55
ID 31



280
ISI LED
IP65
ID 31



282
ARKEON MED
ID 46

EMERGENCY



288
RETRACK
ID 13



288
REM
CEILING EVO
ID 13



288
REM
RECESSED
ID 13

OUTDOOR IP



292
HALL LED
IP65
ID 38



297
HALL LED
CEILING IP65
ID 28



300
HALL LED
GROUND
ID 38



305
WALKABOUT
ID 93



309
TERES IP66
ID 14



312
MOON
ID 51



315
BEN IP54
ID 10



318
GLEIS
ID 61



320
NOBIS
ID 90



324
SCOUT
ID 91



327
MAGIS
FLOOD
ID 92

PRODUCTS INDEX

ALPHABETICAL ORDER

A

ABSENT ESSENTIAL	114
ARKEON	17
ARKEON MED	282
ARKEON WALL	247

B

BEN	84 - 124
BEN IP54	315
BEN LV	211
BOX LED	155
BRIGHT	28

C

CUBE MINI	152
-----------	-----

D

DIAMANTE	47
DIMPLES	119

E

ENDO	55
ERGO	252
ERGO ESSENTIAL	256
ETER	14
EUROSTANDARD TRACK	178

F

FLIP	121
------	-----

G

GHOSTFEED	206
GLEIS	318
GROOVE	33
GROOVE DISPLAY	76
GROOVE DISPLAY IP54	271
GROOVE IP54	268

H

HALL LED CEILING EVO	171
HALL LED CEILING IP65	297
HALL LED DEEP	150
HALL LED ESSENTIAL	161
HALL LED ESSENTIAL CEILING	175
HALL LED GROUND	300
HALL LED IP65	292
HALL LED PRO	158

I

ISI LED IP55	278
ISI LED IP65	280
ISIB LED IP54	276

J

JOOLS	96
JOOLS LV	223

L

LINEA IP54	259
LITE	109 - 116
LUDO SPOT	217
LUDO LINEAR 2.0	219
LUDO LINEAR DK	221
LV TRACK	184

M

MAGIS FLOOD	327
MAKE	130
MAKE O	138
MAKE R	143
MONOD	230
MOON	312

N

NEXT	166
NEXT DK LV	209
NOBIS	320

O

ONE RING	80
OTELLO LED	163
OVVIO DISPLAY LED	73

P

PCMEVO	262
PHORMA	38
PIPE LINE	91
PIPE LINE MONO	94
PROFREEL	61
PROFREEL SLIM	65

Q

QI	200
----	-----

R

REM	288
-----	-----

S

SCOUT	324
SEMPlice LED	44
STILLA	264
STYLO	98
STYLO LV	225

T

TERES	188
TERES EXTE	195
TERES IP66	309
TERES LV	215
TERES MICRO ZOOM	213
TERES MICRO ZOOM RECESSED	147
TOIK	228

U

UPLIK	239
-------	-----

V

VECTOR	50
--------	----

W

WALKABOUT	305
WAVE	100
WAVE DISPLAY	71

NEW PRODUCTS



ETER

ID 62



- CONTINUOUS ROWS
- INNOVATIVE AND EFFICIENT OPTICS
- ETHEREAL FULL LIGHT BODY
- PG. 14



ENDO

ID 55



- CONTINUOUS ROWS
- COMPACT SECTION VERSATILE PROFILE
- COUNTLESS CONFIGURATIONS
- PG. 55



MAKE Q

ID 39



- DOWNLIGHT
- ADJUSTABLE WITH SQUARE BASE
- SINGLE AND DOUBLE OPTICS
- PG. 138



MAKE R

ID 39



- DOWNLIGHT
- SWIVEL, ADJUSTABLE AND RETRACTABLE
- FOR DYNAMIC LIGHTING
- PG. 143



GHOSTFEED 2.0

ID 15



- LOW VOLTAGE
- SINGLE CABLE SYSTEM
- MINIMAL INSTALLATION IMPACT
- PG. 206



TOIK

ID 56



- WALL
- ESSENTIAL AND COMPACT BODY
- HIGH TECHNOLOGICAL CONTENTS
- PG. 228



WALKABOUT

ID 93



- OUTDOOR IP
- WALKABLE LIGHT LINES
- FOR FLOORING AND FACADES
- PG. 305



GLEIS

ID 61



- OUTDOOR IP
- COMPACT WITH ADJUSTABLE OPTICS
- DIRECT / INDIRECT EMISSION
- PG. 318



Light as a vocation, light as an expression, light as a value for the growth of our customers. Since 1984 we have been designing and **manufacturing design lighting solutions** for indoor and outdoor spaces, offering a full range of products and specific expertise in architectural lighting.

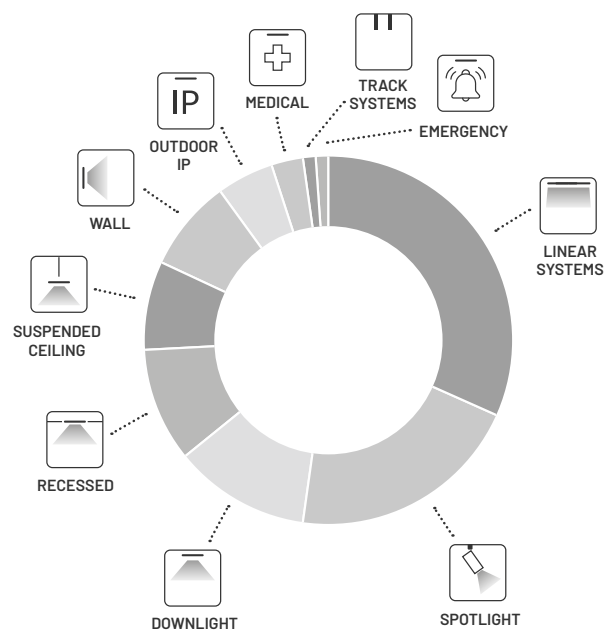

YOUR BUSINESS,
UNDER A NEW LIGHT.

CONTINUOUS INNOVATION BETWEEN RESEARCH AND EXPERIENCE

Attention to performance is at the center of our **design philosophy**, a focus increasing toward technological and stylistic research to be ready to provide **innovative and performing solutions** in a constantly evolving market. The design ideas, derived from **the expertise acquired over years of experience**, merge with the impulses gathered from the world of lighting and the collaboration with the best international design firms.

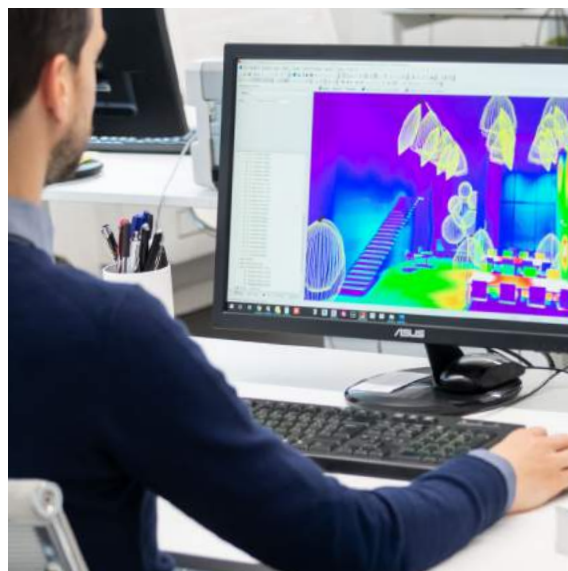
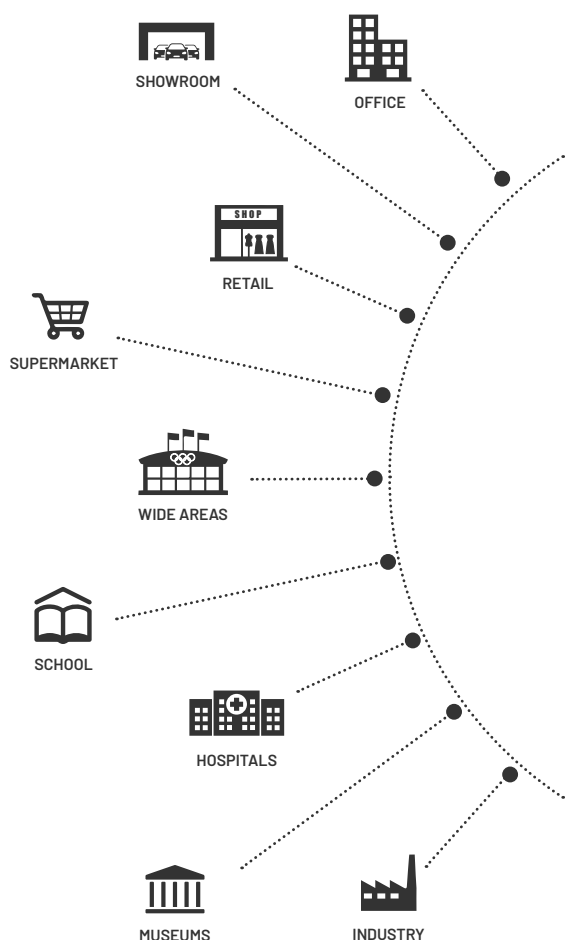

Offices, companies, schools and universities but also museums, theaters, conference rooms. **The whole world of retail and large-scale distribution**, as well as specialist clinics and hospitals. Large public infrastructure such as railways and metro stations. Successes that, rewarding us over the years with the trust of the market, have allowed us to contribute to the **realization of important architectural projects**, with dedicated products both **indoors and outdoors**.















BRILLIANT SOLUTIONS, IN EVERY FIELD.

CONTINUOUS ROWS



C
H
A
P
T
E
R

O
N
E

Eter	14	ID62	
Arkeon	17	ID46	
Bright	28	ID80	
Groove	33	ID43	
Phorma	38	ID89	
Semplice Led	44	ID67	
Diamante	47	ID82	
Vector	50	ID84	
Endo	55	ID55	
Profreel	61	ID83	
Profreel Slim	65	ID83	
Flex Strip Led	67	ID83	
Wave Display	71	ID85	
Ovvio Display Led	73	ID40	
Groove Display	76	ID43	





ETER

ETER is the new elegant **full-light compact suspension**. A monolith that ensures a homogeneous direct and indirect emission thanks to the **sophisticated optical refraction system**. The flux of the single light source is partialized by the internal diffuser, ensuring exceptional performance, great competitiveness and a **specific attention towards energy saving**. **ETER** is available with PG optic, perfect for common areas and passageways thanks to the diffused light and its refined design, while the innovative version with CPL optic has a UGR <16 that satisfies the need for **high visual comfort** of office environment. Eter synthesizes **top-level performance** in an ethereal body with an extremely slim profile.







ID 62



FEATURES

-  Direct/Indirect emission
-  UGR <16; <22
-  IP 40



LED

-  3000K/4000K
-  >140lm/W
-  CRI >90
-  Eye safety: R60/R61
-  Mac Adams 3
-  L80/B10 >50.000h

CERTIFICATIONS

-  EEA Conformity
-  Energy efficiency
-  5 years warranty

ON REQUEST

-  DALI - code D
-  Bluetooth - code BT*
-  Emergency 1 hr - code EM
Emergency 3 hrs - code EM3R*

SPECIFICATIONS

Built-in driver.
CPL technology for UGR <16.
PG diffuser for homogeneous emission with UGR <22.

BODY

Aluminum with epoxy powder coating.
Antistatic methacrylate optics.

COLORS

Matte white RAL 9003 - code B

* Where available

ETER^{CPL}

Accessories on page 16.

IP 40

Innovative CPL optics UGR <16.
Double emission luminaire for direct/indirect light,
for environments with display screen equipment.

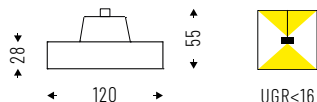

Cod. 4000K	☼	lm	mm
62CPL31K4	31W	3324	1419
62CPL62K4	62W	6283	1419
62CPL43K4	43W	4655	1979
62CPL86K4	86W	8796	1979
62CPL54K4	54W	5985	2539
62CPL110K4	110W	11310	2539
62CPL66K4	66W	7313	3099
62CPL135K4	135W	13823	3099

Cod. 3000K	☼	lm	mm
62CPL31K3	31W	3192	1419
62CPL62K3	62W	6032	1419
62CPL43K3	43W	4468	1979
62CPL86K3	86W	8444	1979
62CPL54K3	54W	5745	2539
62CPL110K3	110W	10857	2539
62CPL66K3	66W	7021	3099
62CPL135K3	135W	13270	3099

ETER^{PG}

Accessories on page 16.

IP 40

Antistatic methacrylate diffuser UGR <22.
Double emission luminaire for direct/indirect light.

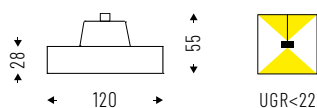

Cod. 4000K	☼	lm	mm
62PG31K4	31W	4936	1419
62PG62K4	62W	9329	1419
62PG43K4	43W	6910	1979
62PG86K4	86W	13061	1979
62PG54K4	54W	8885	2539
62PG110K4	110W	16792	2539
62PG66K4	66W	10859	3099
62PG135K4	135W	20524	3099

Cod. 3000K	☼	lm	mm
62PG31K3	31W	4739	1419
62PG62K3	62W	8956	1419
62PG43K3	43W	6634	1979
62PG86K3	86W	12538	1979
62PG54K3	54W	8529	2539
62PG110K3	110W	16121	2539
62PG66K3	66W	10425	3099
62PG135K3	135W	19703	3099

ACCESSORIES



3 poles-ceiling power cable.
Cable length 2000mm.

00AA16



5 poles-ceiling power cable.
Cable length 2000mm.

00AA165P



Spacers kit for ceiling
mount (2 pieces).

62AA14



Linear joint.

62AA11



Single wire 1500mm /
3000mm long adjustable
suspension kit.

62AA13
62AA1330

TECHNICAL NOTES



The double emission of **ETER** is achieved through a single source: this design allows to contain energy consumption and maintain luminous continuity. In the **PG** version the side reflectors emit diffused light, capable of illuminating the rooms in a homogeneous way.



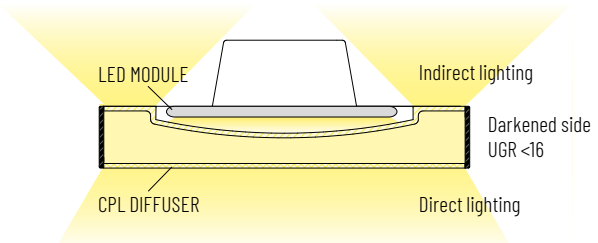
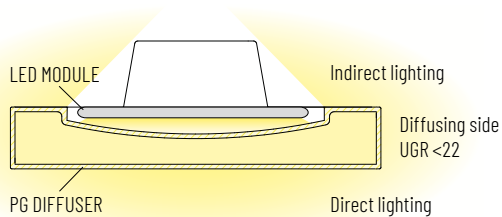

In the **CPL** version, the innovative optics and darkened sides concentrate the direct emission making it suitable for use with screen display, while maintaining the indirect component for ambient lighting.

ETER PG







ETER CPL



FEATURES

-  Direct emission
-  Direct/Indirect emission
-  UGR <16; <19; <22
-  IP 40



LED

-  3000K/4000K
-  >125 lm/W
-  CRI >90
-  Eye safety: R60/R61
-  Mac Adams 3
-  L80/B10 >50.000h

CERTIFICATIONS

-  EEA Conformity
-  Energy efficiency
-  5 years warranty

ON REQUEST

-  DALI - code D*
-  Bluetooth - code BT*
-  Emergency 1 hr - code EM*
Emergency 3 hrs - code EM3R*
-  2700K - code K27*
6500K - code K65*
-  Human Centric Lighting*

SPECIFICATIONS

Built-in driver.
Double emission direct/indirect.
CLD technology (UGR <16) for environments with display screen equipment.
Satin diffuser UGR <22.
Asymmetrical polycarbonate lens.
High Contrast optic.
Continuous indirect emission.
SPOT module with adjustable beam lens of 10° to 40°.

BODY

Aluminum with epoxy powder coating.

COLORS

White RAL 9003 - code B
Black RAL 9005 - code C8

RELATED PRODUCTS

Arkeon Wall (P. 247)
Arkeon Med (P. 282)

* Where available



ARKEON is the new profile developed by Esse-ci to be extremely **flexible and high performing**. A linear design that integrates perfectly in any context such as an office, showroom, a retail or hospitality space. Available with both direct and direct/indirect emission, it **guarantees a seamless illumination**, even for the indirect part. Different optics are available, such as the new **CLD collimated optics** and the **High Contrast optics** as well as the possibility of inserting spot modules for accent lighting.

ID 46

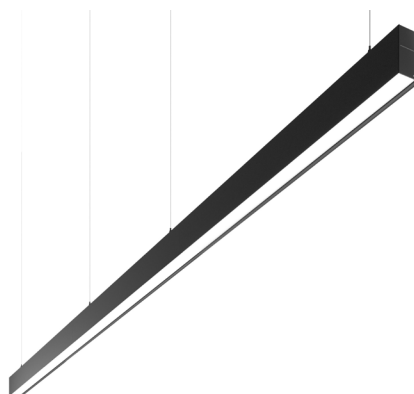

ARKEON HIGH EFFICIENCY CLD

Accessories on page 27.

IP 40

Direct emission with CLD technology diffuser (collimated diffuser UGR<16) for environments with display screen equipment.

End caps not included.

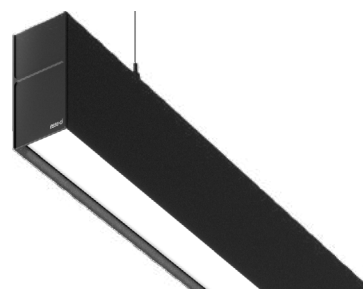
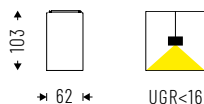

Cod. 4000K	Icon	Im	L mm
46DR19CLDK4	19W	1917	1128
46DR24CLDK4	24W	2422	1408
46DR29CLDK4	29W	2927	1688
46DR34CLDK4	34W	3431	1968
46DR38CLDK4	38W	3835	2248
46DR43CLDK4	43W	4339	2528
46DR48CLDK4	48W	4844	2808
46DR53CLDK4	53W	5349	3088

Cod. 3000K	Icon	Im	L mm
46DR19CLDK3	19W	1844	1128
46DR24CLDK3	24W	2329	1408
46DR29CLDK3	29W	2814	1688
46DR34CLDK3	34W	3299	1968
46DR38CLDK3	38W	3687	2248
46DR43CLDK3	43W	4172	2528
46DR48CLDK3	48W	4658	2808
46DR53CLDK3	53W	5143	3088

ARKEON HIGH EFFICIENCY CLD DOUBLE EMISSION

Accessories on page 27.

IP 40

Direct/Indirect emission with CLD technology diffuser (UGR<16) for environments with display screen equipment. Continuous indirect emission and separate power-on.

End caps not included.

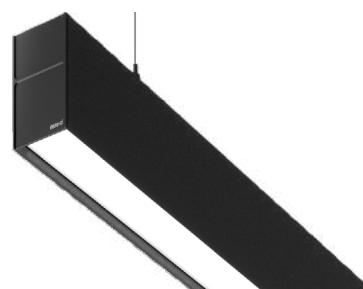
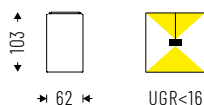

Cod. 4000K	Icon	Im	L mm
46DI38CLDK4	38W: 19W+19W	4761	1128
46DI48CLDK4	48W: 24W+24W	6014	1408
46DI58CLDK4	58W: 29W+29W	7267	1688
46DI68CLDK4	68W: 34W+34W	8520	1968
46DI76CLDK4	76W: 38W+38W	9522	2248
46DI86CLDK4	86W: 43W+43W	10775	2528
46DI96CLDK4	96W: 48W+48W	12028	2808
46DI106CLDK4	106W: 53W+53W	13281	3088

Cod. 3000K	Icon	Im	L mm
46DI38CLDK3	38W: 19W+19W	4578	1128
46DI48CLDK3	48W: 24W+24W	5782	1408
46DI58CLDK3	58W: 29W+29W	6987	1688
46DI68CLDK3	68W: 34W+34W	8192	1968
46DI76CLDK3	76W: 38W+38W	9156	2248
46DI86CLDK3	86W: 43W+43W	10360	2528
46DI96CLDK3	96W: 48W+48W	11565	2808
46DI106CLDK3	106W: 53W+53W	12770	3088

ARKEON HIGH OUTPUT CLD

Accessories on page 27.

IP 40

Direct emission with CLD technology diffuser (collimated diffuser UGR<16) for environments with display screen equipment.

End caps not included.

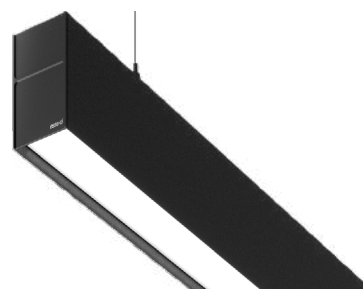
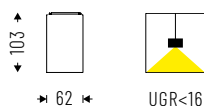

Cod. 4000K	W	lm	L mm
46DR40CLDK4HO	40W	3699	1128
46DR50CLDK4HO	50W	4624	1408
46DR60CLDK4HO	60W	5549	1688
46DR70CLDK4HO	70W	6474	1968
46DR80CLDK4HO	80W	7398	2248
46DR90CLDK4HO	90W	8323	2528
46DR100CLDK4HO	100W	9248	2808
46DR110CLDK4HO	110W	10173	3088

Cod. 3000K	W	lm	L mm
46DR40CLDK3HO	40W	3529	1128
46DR50CLDK3HO	50W	4411	1408
46DR60CLDK3HO	60W	5294	1688
46DR70CLDK3HO	70W	6176	1968
46DR80CLDK3HO	80W	7058	2248
46DR90CLDK3HO	90W	7940	2528
46DR100CLDK3HO	100W	8823	2808
46DR110CLDK3HO	110W	9705	3088

ARKEON HIGH OUTPUT CLD DOUBLE EMISSION

Accessories on page 27.

IP 40

Direct/Indirect emission with CLD technology diffuser (UGR<16) for environments with display screen equipment. Continuous indirect emission and separate power-on.

End caps not included.

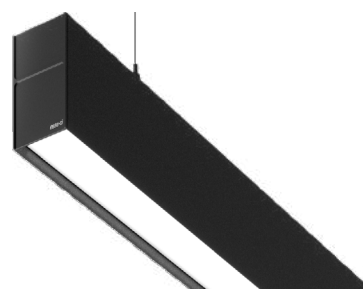
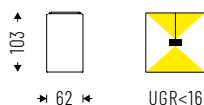

Cod. 4000K	W	lm	L mm
46DI59CLDK4HO	59W: 40W+19W	6618	1128
46DI74CLDK4HO	74W: 50W+24W	8300	1408
46DI89CLDK4HO	89W: 60W+29W	9982	1688
46DI104CLDK4HO	104W: 70W+34W	11665	1968
46DI118CLDK4HO	118W: 80W+36W	13235	2248
46DI133CLDK4HO	133W: 90W+43W	14918	2528
46DI148CLDK4HO	148W: 100W+48W	16600	2808
46DI163CLDK4HO	163W: 110W+53W	18282	3088

Cod. 3000K	W	lm	L mm
46DI59CLDK3HO	59W: 40W+19W	6313	1128
46DI74CLDK3HO	74W: 50W+24W	7918	1408
46DI89CLDK3HO	89W: 60W+29W	9523	1688
46DI104CLDK3HO	104W: 70W+34W	11128	1968
46DI118CLDK3HO	118W: 80W+36W	12626	2248
46DI133CLDK3HO	133W: 90W+43W	14231	2528
46DI148CLDK3HO	148W: 100W+48W	15836	2808
46DI163CLDK3HO	163W: 110W+53W	17441	3088

ARKEON HIGH EFFICIENCY PG

Accessories on page 27.

IP 40

Antistatic satin methacrylate diffuser screen,
UGR <22.

End caps not included.

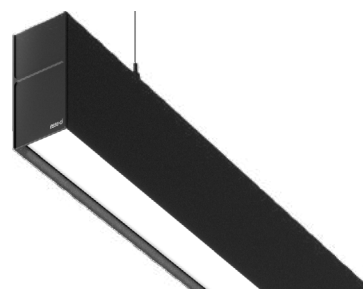
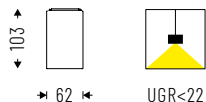

Cod. 4000K	W	lm	L mm
46DR19PGK4	19W	2198	1128
46DR24PGK4	24W	2777	1408
46DR29PGK4	29W	3356	1688
46DR34PGK4	34W	3934	1968
46DR38PGK4	38W	4397	2248
46DR43PGK4	43W	4975	2528
46DR48PGK4	48W	5554	2808
46DR53PGK4	53W	6133	3088

Cod. 3000K	W	lm	L mm
46DR19PGK3	19W	2114	1128
46DR24PGK3	24W	2670	1408
46DR29PGK3	29W	3226	1688
46DR34PGK3	34W	3783	1968
46DR38PGK3	38W	4228	2248
46DR43PGK3	43W	4784	2528
46DR48PGK3	48W	5340	2808
46DR53PGK3	53W	5896	3088

ARKEON HIGH EFFICIENCY PG DOUBLE EMISSION

Accessories on page 27.

IP 40

Antistatic satin methacrylate diffuser screen,
UGR <22. Continuous indirect emission and separate
power-on.

End caps not included.

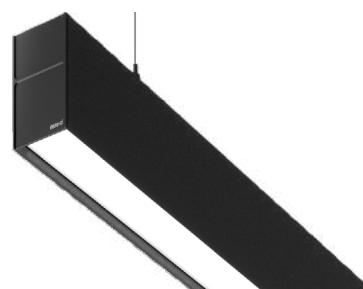
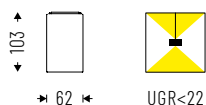

Cod. 4000K	W	lm	L mm
46DI38PGK4	38W: 19W+19W	5083	1128
46DI48PGK4	48W: 24W+24W	6420	1408
46DI58PGK4	58W: 29W+29W	7758	1688
46DI68PGK4	68W: 34W+34W	9095	1968
46DI76PGK4	76W: 38W+38W	10165	2248
46DI86PGK4	86W: 43W+43W	11503	2528
46DI96PGK4	96W: 48W+48W	12840	2808
46DI106PGK4	106W: 53W+53W	14178	3088

Cod. 3000K	W	lm	L mm
46DI38PGK3	38W: 19W+19W	4887	1128
46DI48PGK3	48W: 24W+24W	6173	1408
46DI58PGK3	58W: 29W+29W	7459	1688
46DI68PGK3	68W: 34W+34W	8745	1968
46DI76PGK3	76W: 38W+38W	9774	2248
46DI86PGK3	86W: 43W+43W	11060	2528
46DI96PGK3	96W: 48W+48W	12346	2808
46DI106PGK3	106W: 53W+53W	13632	3088

ARKEON HIGH OUTPUT PG

Accessories on page 27.

IP 40

Antistatic satin methacrylate diffuser screen,
UGR <22.

End caps not included.

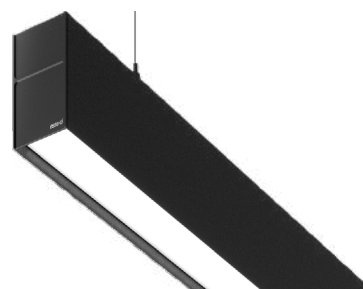
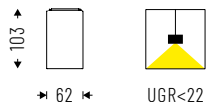

Cod. 4000K	☼	lm	L mm
46DR40PGK4HO	40W	4259	1128
46DR50PGK4HO	50W	5324	1408
46DR60PGK4HO	60W	6389	1688
46DR70PGK4HO	70W	7454	1968
46DR80PGK4HO	80W	8518	2248
46DR90PGK4HO	90W	9583	2528
46DR100PGK4HO	100W	10648	2808
46DR110PGK4HO	110W	11713	3088

Cod. 3000K	☼	lm	L mm
46DR40PGK3HO	40W	4063	1128
46DR50PGK3HO	50W	5079	1408
46DR60PGK3HO	60W	6095	1688
46DR70PGK3HO	70W	7111	1968
46DR80PGK3HO	80W	8127	2248
46DR90PGK3HO	90W	9142	2528
46DR100PGK3HO	100W	10158	2808
46DR110PGK3HO	110W	11174	3088

ARKEON HIGH OUTPUT PG DOUBLE EMISSION

Accessories on page 27.

IP 40

Antistatic satin methacrylate diffuser screen,
UGR <22. Continuous indirect emission and separate
power-on.

End caps not included.

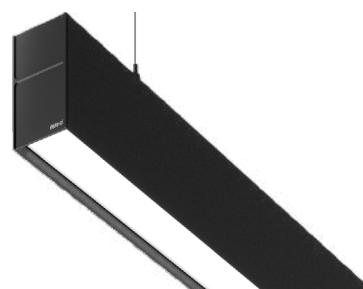
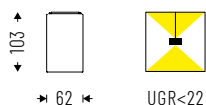

Cod. 4000K	☼	lm	L mm
46DI59PGK4HO	59W: 40W+19W	7094	1128
46DI74PGK4HO	74W: 50W+24W	8897	1408
46DI89PGK4HO	89W: 60W+29W	10700	1688
46DI104PGK4HO	104W: 70W+34W	12504	1968
46DI118PGK4HO	118W: 80W+36W	14187	2248
46DI133PGK4HO	133W: 90W+43W	15991	2528
46DI148PGK4HO	148W: 100W+48W	17794	2808
46DI163PGK4HO	163W: 110W+53W	19597	3088

Cod. 3000K	☼	lm	L mm
46DI59PGK3HO	59W: 40W+19W	6767	1128
46DI74PGK3HO	74W: 50W+24W	8488	1408
46DI89PGK3HO	89W: 60W+29W	10208	1688
46DI104PGK3HO	104W: 70W+34W	11929	1968
46DI118PGK3HO	118W: 80W+36W	13535	2248
46DI133PGK3HO	133W: 90W+43W	15255	2528
46DI148PGK3HO	148W: 100W+48W	16975	2808
46DI163PGK3HO	163W: 110W+53W	18696	3088

ARKEON HIGH EFFICIENCY AS

Accessories on page 27.

IP 40

PMMA lens for asymmetrical beam.

End caps not included.

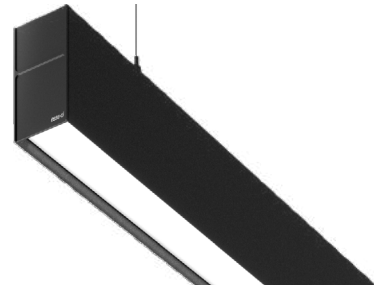
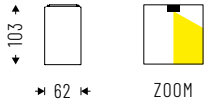

Cod. 4000K	Icon	lm	L mm
46DR19ASK4	19W	2513	1128
46DR24ASK4	24W	3174	1408
46DR29ASK4	29W	3835	1688
46DR34ASK4	34W	4497	1968

Cod. 3000K	Icon	lm	L mm
46DR19ASK3	19W	2416	1128
46DR24ASK3	24W	3052	1408
46DR29ASK3	29W	3688	1688
46DR34ASK3	34W	4323	1968

ARKEON HIGH OUTPUT AS

Accessories on page 27.

IP 40

PMMA lens for asymmetrical beam.

End caps not included.

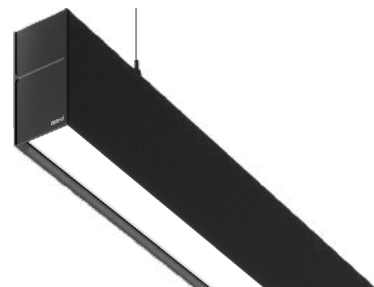
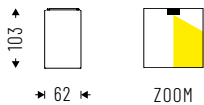

Cod. 4000K	Icon	lm	L mm
46DR40ASK4HO	40W	4874	1128
46DR50ASK4HO	50W	6092	1408
46DR60ASK4HO	60W	7310	1688
46DR70ASK4HO	70W	8529	1968

Cod. 3000K	Icon	lm	L mm
46DR40ASK3HO	40W	4649	1128
46DR50ASK3HO	50W	5812	1408
46DR60ASK3HO	60W	6974	1688
46DR70ASK3HO	70W	8136	1968

ARKEON DK DOUBLE EMISSION

Accessories on page 27.

IP 40

High Contrast microcell diffuser (UGR<16).

End caps not included.

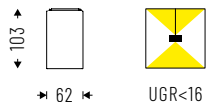

Cod. 4000K		lm	L mm
46DI55DKK4	55W: 36W+19W	5990	1128
46DI69DKK4	69W: 45W+24W	7515	1408
46DI83DKK4	83W: 54W+29W	9041	1688
46DI97DKK4	97W: 63W+34W	15030	1968

Cod. 3000K		lm	L mm
46DI55DKK3	55W: 36W+19W	5575	1128
46DI69DKK3	69W: 45W+24W	6989	1408
46DI83DKK3	83W: 54W+29W	8408	1688
46DI97DKK3	97W: 63W+34W	13978	1968

ARKEON FREE PROFILE SUSPENDED/CEILING

Accessories on page 27.

IP 20

5 poles pre-wired aluminum body for ceiling and suspension applications.

10 poles on request.

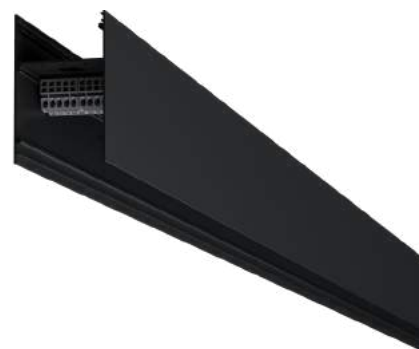
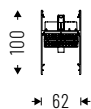

COD	mm
46AA2241	2241
46AA2801	2801
46AA3361	3361

ARKEON FREE SPOT2X

Accessories on page 27.

IP 40

Internal lens: adjustable emission from 10° to 40°

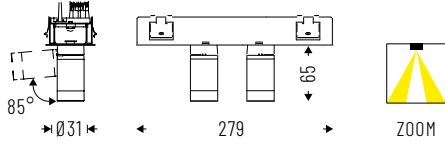

Cod. 4000K		Im
46ZM23K4	2x3W	524
46ZM27K4	2x7W	1120

Cod. 3000K		Im
46ZM23K3	2x3W	476
46ZM27K3	2x7W	1020

ARKEON FREE HIGH EFFICIENCY DIRECT

Accessories on page 27.

IP 20

High efficiency indirect lighting module , CRI>90.



Cod. 4000K		Im	L mm
46AA5K4	5W	780	280
46AA10K4	10W	1560	560
46AA14K4	14W	2340	840
46AA19K4	19W	3120	1120
46AA24K4	24W	3900	1400
46AA29K4	29W	4680	1680

Cod. 3000K		Im	L mm
46AA5K3	5W	750	280
46AA10K3	10W	1500	560
46AA14K3	14W	2250	840
46AA19K3	19W	3000	1120
46AA24K3	24W	3750	1400
46AA29K3	29W	4500	1680

ARKEON FREE HIGH EFFICIENCY INDIRECT

Accessories on page 27.

IP 20

High efficiency indirect lighting module, CRI>90.



Cod. 4000K		lm	L mm
46AA5K4HEIN	5W	780	280
46AA10K4HEIN	10W	1560	560
46AA14K4HEIN	14W	2340	840
46AA19K4HEIN	19W	3120	1120
46AA24K4HEIN	24W	3900	1400
46AA29K4HEIN	29W	4680	1680

Cod. 3000K		lm	L mm
46AA5K3HEIN	5W	750	280
46AA10K3HEIN	10W	1500	560
46AA14K3HEIN	14W	2250	840
46AA19K3HEIN	19W	3000	1120
46AA24K3HEIN	24W	3750	1400
46AA29K3HEIN	29W	4500	1680

ARKEON FREE HIGH OUTPUT DIRECT

Accessories on page 27.

IP 20

High output direct lighting module, CRI>90.



Cod. 4000K		lm	L mm
46AA10K4HO	10W	1520	280
46AA20K4HO	20W	3040	560
46AA30K4HO	30W	4560	840
46AA40K4HO	40W	6080	1120
46AA50K4HO	50W	7600	1400
46AA60K4HO	60W	9120	1680

Cod. 3000K		lm	L mm
46AA10K3HO	10W	1450	280
46AA20K3HO	20W	2900	560
46AA30K3HO	30W	4350	840
46AA40K3HO	40W	5800	1120
46AA50K3HO	50W	7250	1400
46AA60K3HO	60W	8700	1680

ARKEON FREE HIGH OUTPUT INDIRECT

IP 20

High output indirect lighting module , CRI>90.

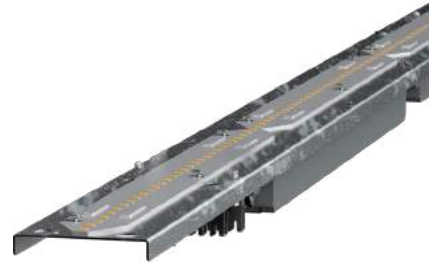

Cod. 4000K	☼	lm	L mm
46AA10K4HOIN	10W	1520	280
46AA20K4HOIN	20W	3040	560
46AA30K4HOIN	30W	4560	840
46AA40K4HOIN	40W	6080	1120
46AA50K4HOIN	50W	7600	1400
46AA60K4HOIN	60W	9120	1680

Cod. 3000K	☼	lm	L mm
46AA10K3HOIN	10W	1450	280
46AA20K3HOIN	20W	2900	560
46AA30K3HOIN	30W	4350	840
46AA40K3HOIN	40W	5800	1120
46AA50K3HOIN	50W	7250	1400
46AA60K3HOIN	60W	8700	1680

ACCESSORIES



Single wire 1500mm / 3000mm long adjustable suspension kit.

46AA13
46AA1330



Ceiling mounting kit.

46AA14



3, 5, 7, 10 poles-ceiling rose power cable. Cable length 2000mm.

00AA16
00AA165P
00AA167P
00AA1610P



End caps kit. (Length: 7mm - already included in the product total length)

46AA09
46AA09AS - ASYMMETRIC



Electrified linear joint.

46AA11



2 ways joint. (Dim: 316 x 316mm)

46AA05



3 ways joint. (Dim: 316 x 570mm)

46AA06



4 ways joint. (Dim: 570 x 570mm)

46AA07

ACCESSORIES



2 ways luminous joint 90°.
(Dim: 316 x 316mm)

46DR10K4A90: 10W(HE) 4000K
46DR10K3A90: 10W(HE) 3000K
46DR20K4A90: 20W(HO) 4000K
46DR20K3A90: 20W(HO) 3000K



CLD optic (collimated diffuser, UGR<16) 5 - 10m coil to be cut on site, to provide continuous and gap-free light diffusion.

46CLD5000
46CLD10000



Satin methacrylate diffuser, 5 - 10m coil to be cut on site, to provide continuous and gap-free light diffusion.

46PG5000
46PG10000



Optional transparent diffuser, 5 - 10m coil to be cut on site, to provide continuous and gap-free light diffusion.

46TR5000
46TR10000

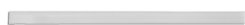

Asymmetric lens, 3000mm.

46AS3000



Blind module connection in painted coil adaptable to size on site.

46MC500
46MC1000

TECHNICAL NOTES

ASSEMBLY SCHEME

ARKEON FREE PROFILE - ARKEON FREE - ARKEON FREE SPOT

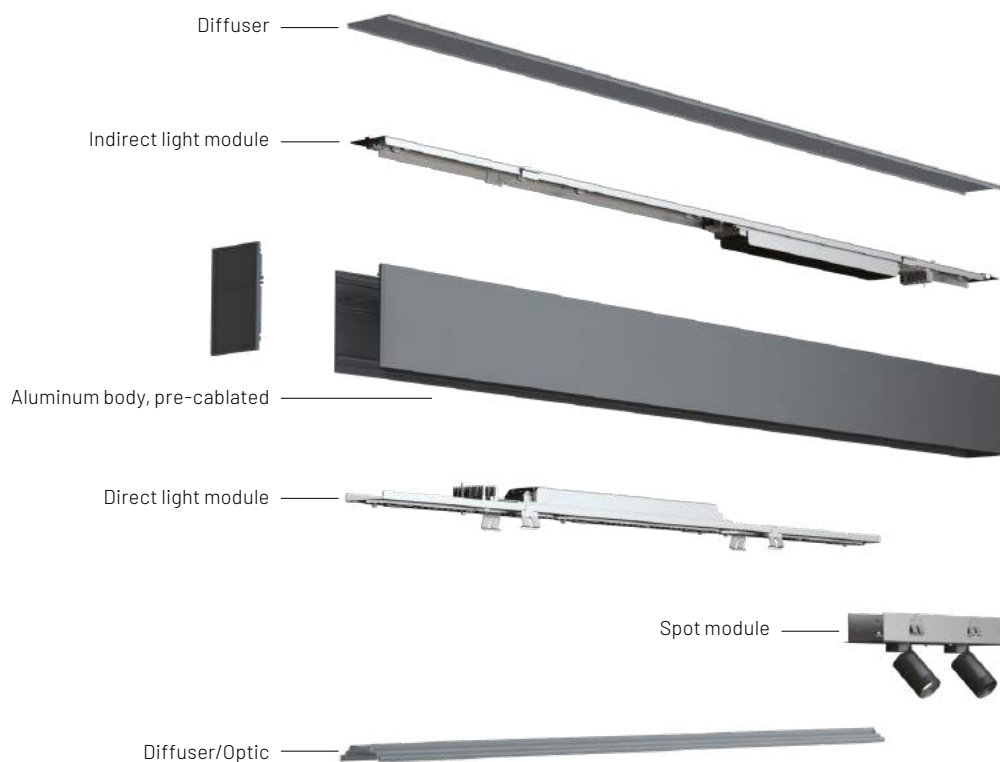







BRIGHT

BRIGHT's body is made of a harness holder and a light module that integrates LED and diffuser. This allows the **accessories to be fixed without any position constraint**, while the integration between LED and diffuser guarantees inaccessibility to the optical compartment. The **electrical connection** between the light module and the batters is **guaranteed by quick connectors** that prevent polarity inversions and false contacts, thus preserving the LED technology.







ID 80



FEATURES

-  Direct emission
-  Direct/Indirect emission
-  UGR <19; <22
-  IP 40





LED

-  3000K/4000K
-  >107 lm/W
-  CRI >90
-  Eye safety: R60/R61
-  Mac Adams 3
-  L80/B10 >50.000h

CERTIFICATIONS

-  EEA Conformity
-  Energy efficiency
-  5 years warranty
-  ETL certification

ON REQUEST

-  DALI - code D
-  Bluetooth - code BT*
-  Emergency 1 hr - code EM*
Emergency 3 hrs - code EM3R*
-  2700K - code K27*
6500K - code K65*
-  HCL Human Centric Lighting*

SPECIFICATIONS

Built-in driver.
DPL technology for controlled emission UGR <19.
PG diffuser for homogeneous emission UGR <22.
Diffuser with ILC technology (Indirect Light Control) for partially indirect emission.

BODY

Aluminum with epoxy powder coating.

COLORS

White RAL 9003 - code B
Black RAL 9005 - code C8

* Where available

BRIGHT DPL LOW POWER

Accessories on page 32.

IP 40

Diffuser with Diamond Prism Technology UGR<19 for environments with display screen equipment. ILC (Indirect Light Control) technology for partially indirect emission.

End caps included.

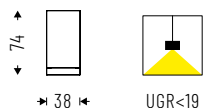

Cod. 4000K	W	lm	L mm
80DPL12K4	12W	1310	568
80DPL18K4	18W	1966	848
80DPL24K4	24W	2621	1128
80DPL30K4	30W	3276	1408
80DPL36K4	36W	3931	1688
80DPL42K4	42W	4586	1968
80DPL48K4	48W	5242	2248
80DPL54K4	54W	5897	2528
80DPL60K4	60W	6552	2808
80DPL66K4	66W	7207	3088

Cod. 3000K	W	lm	L mm
80DPL12K3	12W	1219	568
80DPL18K3	18W	1828	848
80DPL24K3	24W	2437	1128
80DPL30K3	30W	3047	1408
80DPL36K3	36W	3656	1688
80DPL42K3	42W	4265	1968
80DPL48K3	48W	4875	2248
80DPL54K3	54W	5484	2528
80DPL60K3	60W	6093	2808
80DPL66K3	66W	6703	3088

BRIGHT DPL LOW POWER DOUBLE EMISSION

Accessories on page 32.

IP 40

Lower diffuser with Diamond Prism Technology UGR<19 for environments with display screen equipment. ILC (Indirect Light Control) technology and upper PG protective diffuser for dual emission: direct / indirect.

End caps included.

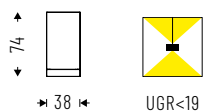

Cod. 4000K	W	lm	L mm
80DI30DPLK4	30W: 24W+6W	3221	1128
80DI36DPLK4	36W: 30W+6W	3877	1408
80DI48DPLK4	48W: 36W+12W	5119	1688
80DI54DPLK4	54W: 42W+12W	5774	1968
80DI72DPLK4	72W: 48W+24W	7617	2248
80DI78DPLK4	78W: 54W+24W	8272	2528
80DI84DPLK4	84W: 60W+24W	8927	2808
80DI90DPLK4	90W: 66W+24W	9582	3088

Cod. 3000K	W	lm	L mm
80DI30DPLK3	30W: 24W+6W	2996	1128
80DI36DPLK3	36W: 30W+6W	3606	1408
80DI48DPLK3	48W: 36W+12W	4761	1688
80DI54DPLK3	54W: 42W+12W	5370	1968
80DI72DPLK3	72W: 48W+24W	7084	2248
80DI78DPLK3	78W: 54W+24W	7693	2528
80DI84DPLK3	84W: 60W+24W	8302	2808
80DI90DPLK3	90W: 66W+24W	8912	3088

BRIGHT PG LOW POWER

Accessories on page 32.

IP 40

Satin methacrylate antistatic diffuser screen, UGR<22.
ILC (Indirect Light Control) technology for partially indirect emission.

End caps included.



Cod. 4000K	W	lm	L mm
80PG6K4	6W	674	288
80PG12K4	12W	1348	568
80PG18K4	18W	2022	848
80PG24K4	24W	2696	1128
80PG30K4	30W	3371	1408
80PG36K4	36W	4045	1688
80PG42K4	42W	4719	1968
80PG48K4	48W	5393	2248
80PG54K4	54W	6067	2528
80PG60K4	60W	6741	2808
80PG66K4	66W	7415	3088

Cod. 3000K	W	lm	L mm
80PG6K3	6W	627	288
80PG12K3	12W	1254	568
80PG18K3	18W	1881	848
80PG24K3	24W	2507	1128
80PG30K3	30W	3134	1408
80PG36K3	36W	3761	1688
80PG42K3	42W	4388	1968
80PG48K3	48W	5015	2248
80PG54K3	54W	5643	2528
80PG60K3	60W	6270	2808
80PG66K3	66W	6896	3088

BRIGHT DI PG LOW POWER DOUBLE EMISSION

Accessories on page 32.

IP 40

Lower satin methacrylate antistatic diffuser screen, UGR<22.
ILC (Indirect Light Control) technology and upper PG protective diffuser for dual emission: direct / indirect.

End caps included.

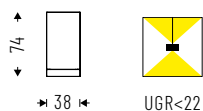

Cod. 4000K	W	lm	L mm
80DI30PGK4	30W: 24W+6W	3297	1128
80DI36PGK4	36W: 30W+6W	3971	1408
80DI48PGK4	48W: 36W+12W	5232	1688
80DI54PGK4	54W: 42W+12W	5906	1968
80DI72PGK4	72W: 48W+24W	7768	2248
80DI78PGK4	78W: 54W+24W	8442	2528
80DI84PGK4	84W: 60W+24W	9116	2808
80DI90PGK4	90W: 66W+24W	9790	3088

Cod. 3000K	W	lm	L mm
80DI30PGK3	30W: 24W+6W	3066	1128
80DI36PGK3	36W: 30W+6W	3693	1408
80DI48PGK3	48W: 36W+12W	4866	1688
80DI54PGK3	54W: 42W+12W	5493	1968
80DI72PGK3	72W: 48W+24W	7224	2248
80DI78PGK3	78W: 54W+24W	7852	2528
80DI84PGK3	84W: 60W+24W	8479	2808
80DI90PGK3	90W: 66W+24W	9106	3088

BRIGHT PG HIGH POWER

Accessories on page 32.

IP 40

Antistatic satin methacrylate diffuser screen, UGR <22.
Diffuser with ILC (Indirect Light Control) technology for partially indirect emission.

End caps included.

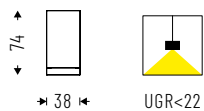

Cod. 4000K	☼	lm	L mm
80PG48K4HP	48W	5393	1128
80PG60K4HP	60W	6741	1408
80PG72K4HP	72W	8089	1688

Cod. 3000K	☼	lm	L mm
80PG48K3HP	48W	5015	1128
80PG60K3HP	60W	6270	1408
80PG72K3HP	72W	7523	1688

ACCESSORIES



Single wire adjustable suspension kit.
Length: 1500 / 3000mm.

80AA13
80AA1330



3 - 5 poles ceiling power box.
Cable length 2000mm.

00AA16
00AA165P



Electrified linear joint.

80AA11



2 ways electrified joint.
(Dim: 60 x 60mm)

80AA05



3 ways electrified joint.
(Dim: 60 x 81,6mm)

80AA06



4 ways electrified joint.
(Dim: 81, 6 x 81,6mm)

80AA07



Blind connection module in aluminium. Linear mechanical joints included. Other lengths on request.

80MC1000: 1000mm
80MC2000: 2000mm



End caps kit for recessed installation.

80AAPIL



Side recessing aluminum profile, also for continuous-row. Each item code is composed of 2 pieces of aluminum profile, joint plates and spacers for alignment. Stirrup brackets magnetically hold the Bright module into the profile for a trimless effect.

80PL24 - 24W(LP) / 48W(HP)
80PL30 - 30W(LP) / 60W(HP)
80PL36 - 36W(LP) / 72W(HP)
80PL42 - 42W(LP)
80PL48 - 48W(LP)
80PL54 - 54W(LP)
80PL60 - 60W(LP)
80PL66 - 66W(LP)



Kit for wall installation.





80AA15







Kit for wall installation.
Bright 6W / 12W.

80AA151M

FEATURES

-  Direct emission
-  Direct/Indirect emission
-  UGR <19
-  IP 40





LED

-  3000K/4000K
- >105 lm/W icon" data-bbox="71 257 98 274"/> >105 lm/W
-  CRI >90
-  Eye safety: R60/R61
-  Mac Adams 3
-  L80/B10 >50.000h

CERTIFICATIONS

-  EEA Conformity
-  Energy efficiency
-  5 years warranty
-  ETL certification

ON REQUEST

-  DALI - code D*
-  Bluetooth - code BT*
-  Emergency 1 hr - code EM*
Emergency 3 hrs - code EM3R*
-  2700K - code K27*
6500K - code K65*
-  Human Centric Lighting*

SPECIFICATIONS

Built-in Driver.
Diffuser with DPL technology,
UGR <19 for environments with
display screen equipment.
Suspended version with double
emission: direct / indirect.
SPOT modules internal aluminum
reflector 50° emission.

BODY

Aluminum with epoxy
powder coating.

COLORS

Matte white RAL 9003 - code B
Matte black RAL 9005 - code C8

RELATED PRODUCTS

Groove Display (P. 76)
Groove IP54 (P. 268)
Groove Display IP54 (P. 271)

* Where available



GROOVE is a **competitive and versatile** profile suitable for recessed, surface and suspended mounting. Produced from painted extruded aluminium in a wide range of lengths and fitted with the latest LED technology for direct or bi-directional light distribution. With its choice of optics, **GROOVE** is a **perfect high performance ambient lighting solution** for commercial applications and, with the additional powerful adjustable accent spotlights, it is also suitable for retail and educational applications. A wide range of accessories are available, making **GROOVE** an **extremely flexible** design tool for architects and lighting designers.



ID 43

GROOVE LOW POWER

Accessories on page 37.

IP 40

Direct emission with DPL technology diffuser (UGR<19).

End caps not included.



Cod. 4000K	Icon	Im	L mm
43DR24DPLK4	24W	2646	1130
43DR30DPLK4	30W	3308	1410
43DR36DPLK4	36W	3969	1690
43DR42DPLK4	42W	4631	1970
43DR48DPLK4	48W	5292	2250
43DR54DPLK4	54W	5954	2533
43DR60DPLK4	60W	6615	2810
43DR66DPLK4	66W	7277	3080

Cod. 3000K	Icon	Im	L mm
43DR24DPLK3	24W	2460	1130
43DR30DPLK3	30W	3077	1410
43DR36DPLK3	36W	3691	1690
43DR42DPLK3	42W	4306	1970
43DR48DPLK3	48W	4921	2250
43DR54DPLK3	54W	5537	2533
43DR60DPLK3	60W	6152	2810
43DR66DPLK3	66W	6767	3080

GROOVE LOW POWER DOUBLE EMISSION

Accessories on page 37.

IP 40

Direct / indirect emission with DPL technology diffuser (UGR<19).

End caps not included.

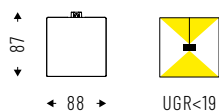

Cod. 4000K	Icon	Im	L mm
43DI30DPLK4	30W: 24W+6W	3329	1130
43DI36DPLK4	36W: 30W+6W	3990	1410
43DI48DPLK4	48W: 36W+12W	5334	1690
43DI54DPLK4	54W: 42W+12W	5996	1970
43DI72DPLK4	72W: 48W+24W	8022	2250
43DI78DPLK4	78W: 54W+24W	8684	2533
43DI84DPLK4	84W: 60W+24W	9345	2810
43DI90DPLK4	90W: 66W+24W	10007	3080

Cod. 3000K	Icon	Im	L mm
43DI30DPLK3	30W: 24W+6W	3095	1130
43DI36DPLK3	36W: 30W+6W	3711	1410
43DI48DPLK3	48W: 36W+12W	4960	1690
43DI54DPLK3	54W: 42W+12W	5576	1970
43DI72DPLK3	72W: 48W+24W	7460	2250
43DI78DPLK3	78W: 54W+24W	8076	2533
43DI84DPLK3	84W: 60W+24W	8691	2810
43DI90DPLK3	90W: 66W+24W	9306	3080

GROOVE HIGH POWER

Accessories on page 37.

IP 40

Direct emission with DPL technology diffuser (UGR<19).

End caps not included.

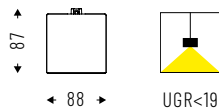

Cod. 4000K	Icon	lm	L mm
43DR45DPLK4HP		45W	4961
43DR57DPLK4HP		57W	6284
43DR68DPLK4HP		68W	7497

Cod. 3000K	Icon	lm	L mm
43DR45DPLK3HP		45W	4614
43DR57DPLK3HP		57W	5844
43DR68DPLK3HP		68W	6972

GROOVE HIGH POWER DOUBLE EMISSION

Accessories on page 37.

IP 40

Direct / indirect emission with DPL technology diffuser (UGR<19).

End caps not included.

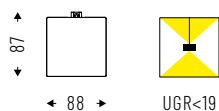

Cod. 4000K	Icon	lm	L mm
43DI51DPLK4HP		51W: 45W+6W	5644
43DI63DPLK4HP		63W: 57W+6W	6967
43DI80DPLK4HP		80W: 68W+12W	10227

Cod. 3000K	Icon	lm	L mm
43DI51DPLK3HP		51W: 45W+6W	5248
43DI63DPLK3HP		63W: 57W+6W	6480
43DI80DPLK3HP		80W: 68W+12W	9511

GROOVE ^{SPOT}

IP 40

Aluminum reflectors 50° beam angle.

Not for single installation.

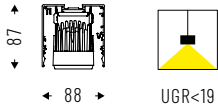

Cod. 4000K		lm	L mm
43AA113K450	1x13W	1x1112	162
43AA213K450	2x13W	2x1112	262
43AA313K450	3x13W	3x1112	362

Cod. 3000K		lm	L mm
43AA113K350	1x13W	1x990	162
43AA213K350	2x13W	2x990	262
43AA313K350	3x13W	3x990	362

ACCESSORIES



Single wire adjustable suspension kit.
Length: 1500 / 3000mm

43AA13
43AA1330



3 - 5 poles ceiling power cable.
Cable length 2000mm.

00AA16
00AA165P



End caps kit. (4 mm thickness already included in the product total length).

43AA09



Blind connection module in aluminium. Linear mechanical joints included

43MC1000: 1000mm
43MC2000: 2000mm



Electrified linear joint.

43AA11



2 ways luminous joint.
(Dim. 202 x 202mm)

43DR12K4A90 12W(LP)4000K
43DR12K3A90 12W(LP)3000K
43DR24K4A90 24W(HP)4000K
43DR24K3A90 24W(HP)3000K



2 ways joint.
(Dim. 202 x 202mm)

43AA05



3 ways joint.
(Dim. 202 x 316mm)

43AA06



4 ways joint.
(Dim. 316 x 316mm)

43AA07



Brackets kit for recessed installation.

43AA17



Satin methacrylate diffuser UGR<22, 10m coil to be measured and cut on site to provide continuous gap-free light diffusion.

43PG10000



Blind module L200mm with constant light and presence sensor.

43AA00DIM





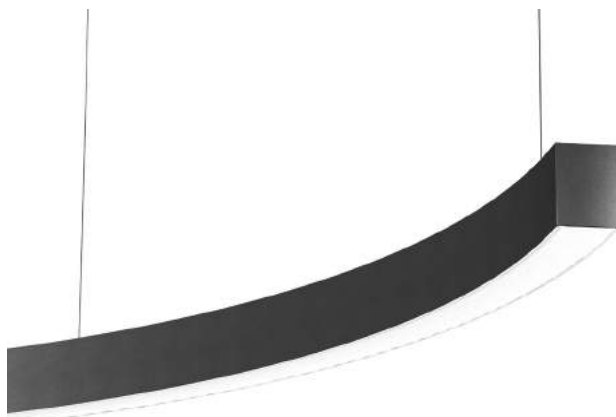

PHORMA

PHORMA is the new system developed to create **free compositions**. With **PHORMA** it is possible to easily create perimeters that are modulated on the geometry of an environment or a furniture and that perfectly illuminate thanks to **PG optics with diffused emission** or **DPL with controlled UGR**. Available both in direct and double emission (direct/indirect) version.







ID 89



FEATURES

-  Direct emission
-  Direct/Indirect emission
-  UGR <19; <22
-  IP 40





LED

-  3000K/4000K
-  >107 lm/W
-  CRI >90
-  Eye safety: RG0/RG1
-  Mac Adams 3
-  L80/B10 >50.000h

CERTIFICATIONS

-  EEA Conformity
-  Energy efficiency
-  5 years warranty

ON REQUEST

-  DALI - code D
-  Bluetooth - code BT*
-  Emergency 1 hr - code EM*
Emergency 3 hrs - code EM3R*
-  2700K - code K27*

SPECIFICATIONS

Driver integrated in the linear elements.
 Driver included (but not integrated) in the curved elements.
 PG diffuser in satin methacrylate for homogeneous UGR <22.
 DPL diffuser with homogeneous and controlled emission UGR <19.

BODY

Aluminum with epoxy powder coating.

COLORS

White RAL 9003 wrinkled - code B
 Black RAL 9005 wrinkled - code C8

* Where available

PHORMA LINE PG

Accessories on page 43.

IP 40

Satin methacrylate diffuser for soft diffusion with UGR<22.

Built-in Driver. End caps not included.

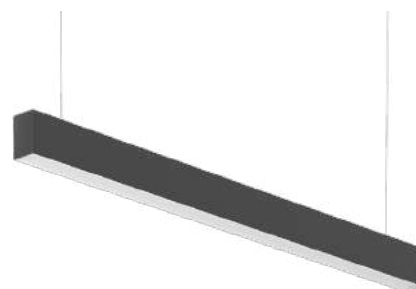
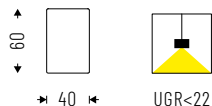

Cod. 4000K		lm	L mm
89PG12K4L	12W	1326	860
89PG16K4L	16W	1768	1145
89PG20K4L	20W	2210	1435
89PG24K4L	24W	2652	1720
89PG28K4L	28W	3090	2008
89PG32K4L	32W	3536	2295

Cod. 3000K		lm	L mm
89PG12K3L	12W	1296	860
89PG16K3L	16W	1728	1145
89PG20K3L	20W	2160	1435
89PG24K3L	24W	2592	1720
89PG28K3L	28W	3020	2008
89PG32K3L	32W	3456	2295

PHORMA LINE PG DOUBLE EMISSION

Accessories on page 43.

IP 40

Satin methacrylate diffuser for soft diffusion with UGR<22. Double emission: direct/indirect.

Built-in Driver. End caps not included.

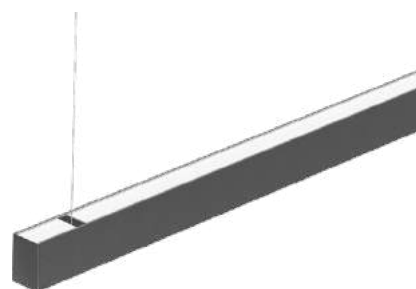
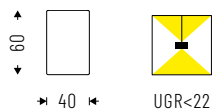

Cod. 4000K		lm	L mm
89DI24PGK4L	24W: 16W+8W	2608	1145
89DI28PGK4L	28W: 20W+8W	3050	1435
89DI32PGK4L	32W: 24W+8W	3492	1720
89DI36PGK4L	36W: 28W+8W	3930	2008
89DI48PGK4L	48W: 32W+16W	5180	2295

Cod. 3000K		lm	L mm
89DI24PGK3L	24W: 16W+8W	2543	1145
89DI28PGK3L	28W: 20W+8W	2975	1435
89DI32PGK3L	32W: 24W+8W	3407	1720
89DI36PGK3L	36W: 28W+8W	3835	2008
89DI48PGK3L	48W: 32W+16W	5051	2295

PHORMA LINE DPL

Accessories on page 43.

IP 40

DPL Diffuser with Diamond Prism LED technology (UGR<19) for environments with display screen equipment. *Built-in Driver. End caps not included.*

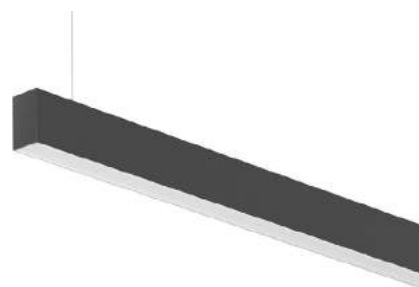
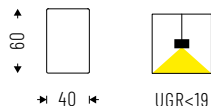

Cod. 4000K	Icon	Im	L mm
89DPL12K4L	12W	1254	860
89DPL16K4L	16W	1673	1145
89DPL20K4L	20W	2091	1435
89DPL24K4L	24W	2509	1720
89DPL28K4L	28W	2923	2008
89DPL32K4L	32W	3345	2295

Cod. 3000K	Icon	Im	L mm
89DPL12K3L	12W	1226	860
89DPL16K3L	16W	1635	1145
89DPL20K3L	20W	2043	1435
89DPL24K3L	24W	2452	1720
89DPL28K3L	28W	2857	2008
89DPL32K3L	32W	3269	2295

PHORMA LINE DPL DOUBLE EMISSION

Accessories on page 43.

IP 40

DPL Diffuser with Diamond Prism LED technology (UGR<19) for environments with display screen equipment. Double emission: direct/indirect.

Built-in Driver. End caps not included.

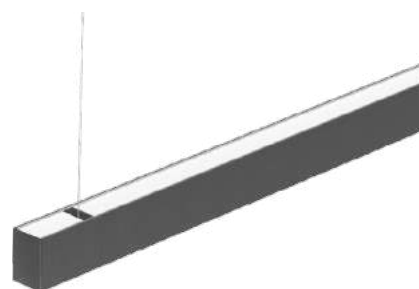
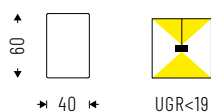

Cod. 4000K	Icon	Im	L mm
89DI24DPLK4L	24W: 16W+8W	2513	1145
89DI28DPLK4L	28W: 20W+8W	2931	1435
89DI32DPLK4L	32W: 24W+8W	3349	1720
89DI36DPLK4L	36W: 28W+8W	3763	2008
89DI48DPLK4L	48W: 32W+16W	4989	2295

Cod. 3000K	Icon	Im	L mm
89DI24DPLK3L	24W: 16W+8W	2450	1145
89DI28DPLK3L	28W: 20W+8W	2858	1435
89DI32DPLK3L	32W: 24W+8W	3267	1720
89DI36DPLK3L	36W: 28W+8W	3672	2008
89DI48DPLK3L	48W: 32W+16W	4864	2295

PHORMA CURVE PG

Accessories on page 43.

IP 40

Satin methacrylate diffuser for soft diffusion with UGR<22.

Driver NOT built-in: to be placed on PHORMA LINE or remotely.
End caps not included.

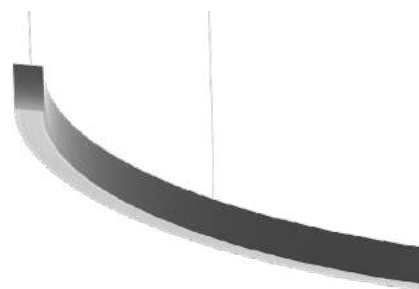
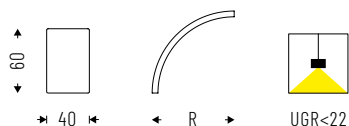

Cod. 4000K	Icon	Im	R mm
89PG16K4C	16W	1768	755
89PG20K4C	20W	2210	930
89PG24K4C	24W	2652	1120
89PG28K4C	28W	3094	1296
89PG32K4C	32W	3536	1480

Cod. 3000K	Icon	Im	R mm
89PG16K3C	16W	1728	755
89PG20K3C	20W	2160	930
89PG24K3C	24W	2592	1120
89PG28K3C	28W	3024	1296
89PG32K3C	32W	3456	1480

PHORMA CURVE PG DOUBLE EMISSION

Accessories on page 43.

IP 40

Satin methacrylate diffuser for soft diffusion with UGR<22. Double emission: direct/indirect.

Driver NOT built-in: to be placed on PHORMA LINE or remotely.
End caps not included.

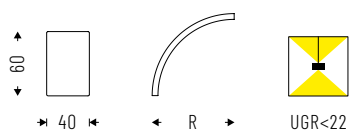

Cod. 4000K	Icon	Im	R mm
89DI28PGK4C	28W: 20W+8W	3050	930
89DI32PGK4C	32W: 24W+8W	3492	1120
89DI36PGK4C	36W: 28W+8W	3934	1296
89DI48PGK4C	48W: 32W+16W	5279	1480

Cod. 3000K	Icon	Im	R mm
89DI28PGK3C	28W: 20W+8W	2975	930
89DI32PGK3C	32W: 24W+8W	3407	1120
89DI36PGK3C	36W: 28W+8W	3839	1296
89DI48PGK3C	48W: 32W+16W	5051	1480

PHORMA CURVE DPL

IP 40

DPL Diffuser with Diamond Prism LED technology (UGR<19) for environments with display screen equipment.

Driver NOT built-in: to be placed on PHORMA LINE or remotely.
End caps not included.

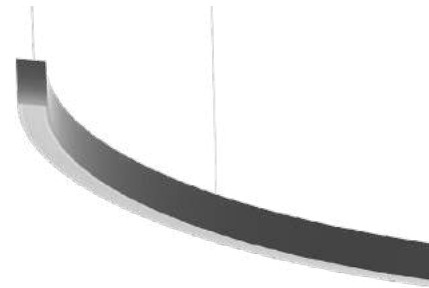
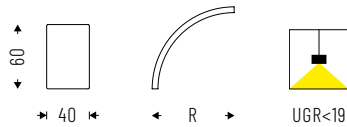

Cod. 4000K	☼	lm	R mm
89DPL16K4C	16W	1673	755
89DPL20K4C	20W	2091	930
89DPL24K4C	24W	2509	1120
89DPL28K4C	28W	2927	1296
89DPL32K4C	32W	3345	1480

Cod. 3000K	☼	lm	R mm
89DPL16K3C	16W	1635	755
89DPL20K3C	20W	2043	930
89DPL24K3C	24W	2452	1120
89DPL28K3C	28W	2861	1296
89DPL32K3C	32W	3269	1480

PHORMA CURVE DPL DOUBLE EMISSION

IP 40

DPL Diffuser with Diamond Prism LED technology (UGR<19) for environments with display screen equipment.

Double emission: direct/indirect.

Driver NOT built-in: to be placed on PHORMA LINE or remotely.
End caps not included.

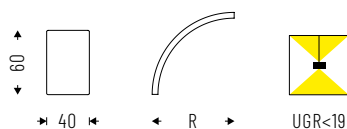

Cod. 4000K	☼	lm	R mm
89DI28DPLK4C	28W: 20W+8W	2931	930
89DI32DPLK4C	32W: 24W+8W	3349	1120
89DI36DPLK4C	36W: 28W+8W	3763	1296
89DI48DPLK4C	48W: 32W+16W	4989	1480

Cod. 3000K	☼	lm	R mm
89DI28DPLK3C	28W: 20W+8W	2858	930
89DI32DPLK3C	32W: 24W+8W	3267	1120
89DI36DPLK3C	36W: 28W+8W	3672	1296
89DI48DPLK3C	48W: 32W+16W	4864	1480

ACCESSORIES

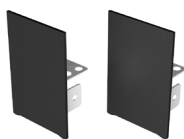

End caps kit.
(Add + 4 mm to body length)

89AA09



3 - 5 - 7 poles ceiling
power box.
Cable length 2000mm.

00AA16
00AA165P
00AA167P



Single adjustable
suspension kit
Length: 1500 / 3000mm.

89AA13
89AA1330



Ceiling mount kit.

89AA14



Curved-Curved concave
joint. Indicate the x and y
radius of the elements
to be joined.

89AAxxyCC



Curved-Curved convex
joint. Indicate the x and y
radius of the elements
to be joined.

89AAxxyCS



Curved-Line
joint. Indicate the x
radius of the elements
to be joined.

89AAxxCL



Line-Line joint.

89AA11M

TECHNICAL NOTES



CODE CREATION FOR CURVED-CURVED JOINTS:

- 1) Define the radii of the 2 elements to be joined:
e.g: 89PG20K4C with radius **930 mm**
89PG28K4C with radius **1296 mm**
- 2) Define whether the joint is concave (**CC**) or convex (**CS**)
- 3) Create the code as follows, first placing the minor radius and then the major:
89AA9301296CC (if concave)
89AA9301296CS (if convex)

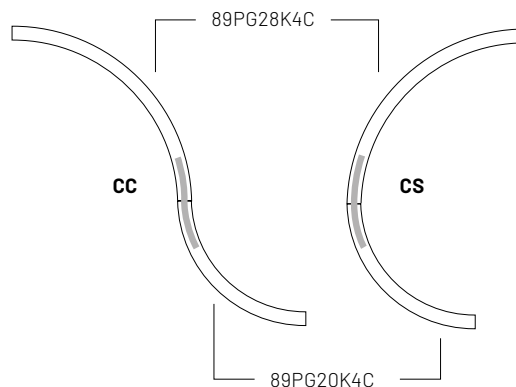



SEMPLICE LED

SEMPLICE LED is an **innovative lighting solution** suited to a wide range of interior applications including commercial, leisure and retail environments. Never before has a product been so versatile, with suspended or directly surface mounted versions available for wall and ceiling mounting. They can be installed individually, continuously mounted or even pattern formed using the tailored range of accessories. Its uniqueness is a **scattered emitted light including the ends**, thanks to the integrated LED technology and translucent end caps. A broad collection of matching products can be implemented for free standing and EU track mounting, giving the user continuity of product and **complete design freedom** in a project.

ID 67









Design
Quargnale // Ruatti studio Architetti





FEATURES

-  Direct/Indirect emission
-  UGR <22
-  IP 40





LED

-  3000K/4000K
-  >90 lm/W
-  CRI >90
-  Eye safety: RG0/RG1
-  Mac Adams 3
-  L80/B10 >50.000h

CERTIFICATIONS

-  EEA Conformity
-  Energy efficiency
-  5 years warranty
-  ETL certification

ON REQUEST

-  DALI - code D*
-  Emergency 1 hr - code EM
Emergency 3 hrs - code EM3R*
-  2700K - code K27*
5000K - code K5*
-  Human Centric Lighting*

SPECIFICATIONS

Integrated driver.
PG optics for soft and homogeneous emission with no shadow areas.
EB optics for side emission.

BODY

Shockproof, antistatic technopolymer with an exclusive paint treatment that guarantees a homogeneous "soft" emission over the entire surface. The ending and junction accessories are made of the same materials, with an invisible coupling fastening system.

* Where available

SEMPLICE LED^{PG}

Accessories on page 46.

IP 40

PMMA technopolymer (UGR<22) with surface treatment for completely uniform light distribution. Integrated LED technology.

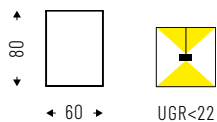

Cod. 4000K	☒	lm	L mm
67PG24K4HP	24W	2268	624
67PG36K4HP	36W	3402	904
67PG48K4HP	48W	4536	1184
67PG72K4HP	72W	6804	1744
67PG108K4HP	108W	10206	2584

Cod. 3000K	☒	lm	L mm
67PG24K3HP	24W	2155	624
67PG36K3HP	36W	3232	904
67PG48K3HP	48W	4309	1184
67PG72K3HP	72W	6464	1744
67PG108K3HP	108W	9696	2584

SEMPLICE LED^{EB}

Accessories on page 46.

IP 40

PMMA technopolymer (UGR<22) with surface treatment and super-pure aluminum reflector for bi-directional light distribution. Integrated LED technology.

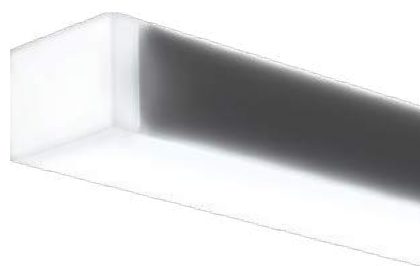
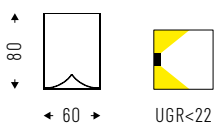

Cod. 4000K	☒	lm	L mm
67EB24K4HP	24W	2167	624
67EB36K4HP	36W	3251	904
67EB48K4HP	48W	4334	1184
67EB72K4HP	72W	6502	1744
67EB108K4HP	108W	9752	2584

Cod. 3000K	☒	lm	L mm
67EB24K3HP	24W	2059	624
67EB36K3HP	36W	3088	904
67EB48K3HP	48W	4118	1184
67EB72K3HP	72W	6176	1744
67EB108K3HP	108W	9265	2584

SEMPLICE LED EUTRACK

IP 40

PMMA technopolymer (UGR<22) with surface treatment for completely uniform light distribution. Integrated LED technology. Fitted with EU Track connector.

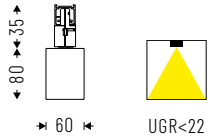

Cod. 4000K	W	lm	L mm
67PG24K4HPAB	24W	2268	624
67PG36K4HPAB	36W	3402	904
67PG48K4HPAB	48W	4536	1184
67PG72K4HPAB	72W	6804	1744
67PG108K4HPAB	108W	10206	2584

Cod. 3000K	W	lm	L mm
67PG24K3HPAB	24W	2155	624
67PG36K3HPAB	36W	3232	904
67PG48K3HPAB	48W	4309	1184
67PG72K3HPAB	72W	6464	1744
67PG108K3HPAB	108W	9696	2584

ACCESSORIES



Single adjustable suspension kit.
Length: 1500 / 3000mm.

67AA13
67AA1330



Spacers kit for wall/ceiling mount.

67AA14



3 - 5 poles ceiling power supply box.
Cable length 2000mm

00AA16
00AA165P



Electrified linear joint with total emission for continuous rows installation.

67AA1LED



Internally electrified creative joint for horizontal change of direction.





67AA05









Internally electrified 90° joint for vertical change of direction.

67AA05V

FEATURES

-  Direct emission
-  Direct/Indirect emission
-  UGR <19
-  IP 40



LED

-  3000K/4000K
-  >82 lm/W
-  CRI >90
-  Eye safety: RG0/RG1
-  Mac Adams 3
-  L80/B10 >50.000h

CERTIFICATIONS

-  EEA Conformity
-  Energy efficiency
-  5 years warranty

ON REQUEST

-  DALI - code D
-  Emergency 1 hr - code EM*
Emergency 3 hrs - code EM3R*

SPECIFICATIONS

Built-in driver.
DPL technology for controlled UGR <19.
Additional raster for glare control in molded and vacuum injected metallized polycarbonate.

BODY

Aluminum with epoxy powder coating.

COLORS

Matte black RAL 9005 - code C8



DIAMANTE has been created as a result of Esse-Ci's passion for unique technical design. It's a peculiar product that achieves **optimum light control with high performance and flexibility** from a single fixture. The DPL diffusion technology for controlled UGR combined with the additional black diamond louvre results in unparalleled glare control, making it the **perfect product for any office application**. Available as a stand-alone product, configurable as a system or in the FREE version, **DIAMANTE** allows the use of the illuminated modules in a versatile way, coupling them with lamp bodies of different sizes.

ID 82



Design
Rossi Bianchi Lighting Design

* Where available

arlico

DIAMANTE LOW POWER

IP 40

DPL technology (Diamond Prism LED) for controlled (UGR <19) with additional polycarbonate raster for glare control.

End caps included.

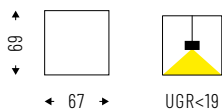

Cod. 4000K	☼	lm	L mm
82DPL12K4	12W	984	577
82DPL18K4	18W	1476	863
82DPL24K4	24W	1968	1149
82DPL30K4	30W	2460	1435
82DPL36K4	36W	2952	1721
82DPL42K4	42W	3360	2007
82DPL48K4	48W	3936	2293
82DPL54K4	54W	4428	2579
82DPL60K4	60W	4920	2865
82DPL66K4	66W	5412	3151

Cod. 4000K	☼	lm	L mm
82DPL12K3	12W	905	577
82DPL18K3	18W	1358	863
82DPL24K3	24W	1811	1149
82DPL30K3	30W	2263	1435
82DPL36K3	36W	2716	1721
82DPL42K3	42W	3091	2007
82DPL48K3	48W	3621	2293
82DPL54K3	54W	4074	2579
82DPL60K3	60W	4526	2865
82DPL66K3	66W	4979	3151

DIAMANTE LOW POWER DOUBLE EMISSION

IP 40

DPL technology (Diamond Prism LED) for controlled (UGR <19) with additional polycarbonate raster for glare control.

End caps included.

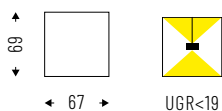

Cod. 4000K	☼	lm	L mm
82DI30DPLK4	30W: 24W+6W	2618	1149
82DI36DPLK4	36W: 30W+6W	3110	1435
82DI48DPLK4	48W: 36W+12W	4252	1721
82DI54DPLK4	54W: 42W+12W	4660	2007
82DI72DPLK4	72W: 48W+24W	6536	2293
82DI78DPLK4	78W: 54W+24W	7028	2579
82DI84DPLK4	84W: 60W+24W	7520	2865
82DI90DPLK4	90W: 66W+24W	8012	3151

Cod. 3000K	☼	lm	L mm
82DI30DPLK3	30W: 24W+6W	2408	1149
82DI36DPLK3	36W: 30W+6W	2860	1435
82DI48DPLK3	48W: 36W+12W	3910	1721
82DI54DPLK3	54W: 42W+12W	4285	2007
82DI72DPLK3	72W: 48W+24W	6009	2293
82DI78DPLK3	78W: 54W+24W	6462	2579
82DI84DPLK3	84W: 60W+24W	6914	2865
82DI90DPLK3	90W: 66W+24W	7367	3151

DIAMANTE HIGH POWER

IP 40

DPL technology (Diamond Prism LED) for controlled (UGR <19) with additional polycarbonate raster for glare control.

End caps included.

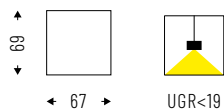

Cod. 4000K	Icon	Im	L mm
82DPL40K4HP	40W	3280	1149
82DPL50K4HP	50W	4100	1435
82DPL60K4HP	60W	4920	1721

Cod. 3000K	Icon	Im	L mm
82DPL40K3HP	40W	3018	1149
82DPL50K3HP	50W	3772	1435
82DPL60K3HP	60W	4526	1721

DIAMANTE HIGH POWER DOUBLE EMISSION

IP 40

DPL technology (Diamond Prism LED) for controlled (UGR <19) with additional polycarbonate raster for glare control.

End caps included.

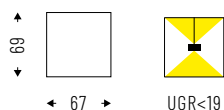

Cod. 4000K	Icon	Im	L mm
82DI46DPLK4HP	46W: 40W+6W	2618	1149
82DI56DPLK4HP	56W: 50W+6W	3110	1435
82DI72DPLK4HP	72W: 60W+12W	4252	1721

Cod. 3000K	Icon	Im	L mm
82DI46DPLK3HP	46W: 40W+6W	2408	1149
82DI56DPLK3HP	56W: 50W+6W	2860	1435
82DI72DPLK3HP	72W: 60W+12W	3910	1721

ACCESSORIES



Single adjustable suspension kit.
Length 1500 / 3000mm.

82AA13
82AA1330



3 - 5 poles ceiling power supply box.
Cable length 2000mm.

00AA16
00AA165P



Electrified linear joint for ceiling and suspended version.

82AA11



Brackets kit for recessed installation.

82AA17





VECTOR

VECTOR is a system designed for the **lighting of commercial spaces** aimed to promote sales and product visibility. Thanks to the **structured wiring** and to the **multiple lenses**, **VECTOR** exceeds any installation limit, reaching maximum results in lighting and energy saving.

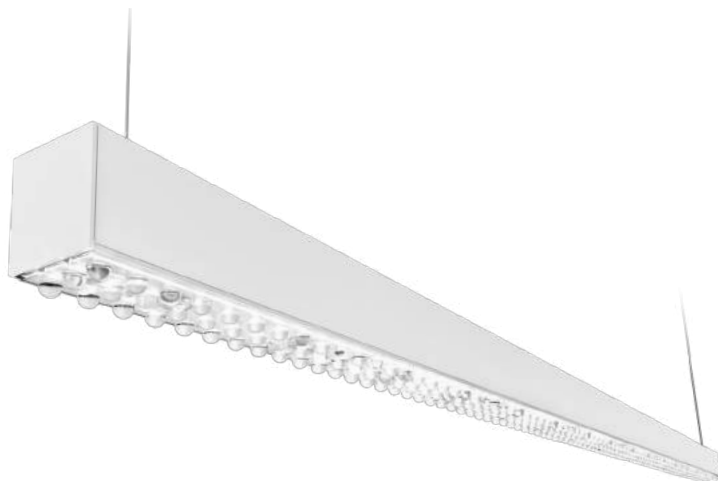



ID 84



FEATURES

-  Direct emission
-  UGR <22
-  IP 40





LED

-  3000K/4000K
- >160 lm/W icon" data-bbox="758 239 788 259"/> >160 lm/W
-  CRI >90
-  Eye safety: R60/R61
-  Mac Adams 3
-  L80/B10 >50.000h

CERTIFICATIONS

-  EEA Conformity
-  Energy efficiency
-  Energy efficiency (SPOT version)
-  5 years warranty

ON REQUEST

-  DALI - code D*
-  Bluetooth - code BT*
-  Emergency 1 hr - code EM*
Emergency 3 hrs - code EM3R*
-  5000K - code K5*

SPECIFICATIONS

Built-in driver.
Concentrating PMMA lens.
Diffusing PMMA lens.
Double asymmetrical PMMA lens.

BODY

Aluminum with epoxy powder coating.

COLORS

Matte white RAL 9003 - code B
Matte black RAL 9005 - code C8

* Where available

VECTOR^{PC}

Accessories on page 54.

IP 40

PMMA lens for concentrating emission 30°.

End caps not included.

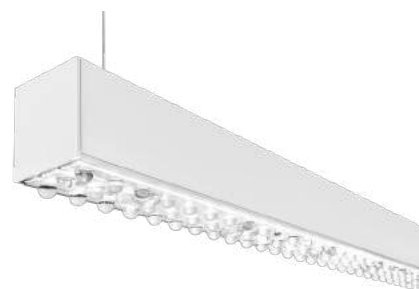
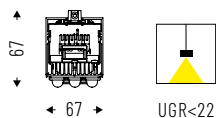

Cod. 4000K	W	lm	L mm
84PC17K4	17W	2426	575
84PC24K4	24W	3355	575
84PC32K4	32W	4852	1149
84PC45K4	45W	6710	1149
84PC40K4	40W	6065	1436
84PC56K4	56W	8388	1436
84PC77K4	77W	12130	2871
84PC107K4	107W	16775	2871

Cod. 3000K	W	lm	L mm
84PC17K3	17W	2340	575
84PC24K3	24W	3218	575
84PC32K3	32W	4680	1149
84PC45K3	45W	6435	1149
84PC40K3	40W	5850	1436
84PC56K3	56W	8044	1436
84PC77K3	77W	11699	2871
84PC107K3	107W	16087	2871

VECTOR^{DS}

Accessories on page 54.

IP 40

PMMA lens for diffused emission.

End caps not included.

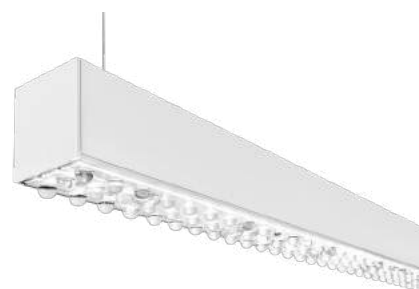
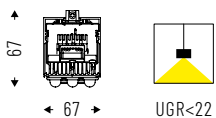

Cod. 4000K	W	lm	L mm
84DS17K4	17W	2360	575
84DS24K4	24W	3264	575
84DS32K4	32W	4721	1149
84DS45K4	45W	6529	1149
84DS40K4	40W	5901	1436
84DS56K4	56W	8161	1436
84DS77K4	77W	11802	2871
84DS107K4	107W	16322	2871

Cod. 3000K	W	lm	L mm
84DS17K3	17W	2277	575
84DS24K3	24W	3130	575
84DS32K3	32W	4553	1149
84DS45K3	45W	6261	1149
84DS40K3	40W	5692	1436
84DS56K3	56W	7826	1436
84DS77K3	77W	11383	2871
84DS107K3	107W	15652	2871

VECTOR^{DAS}

Accessories on page 54.

IP 40

PMMA lens for double asymmetrical emission.

End caps not included.

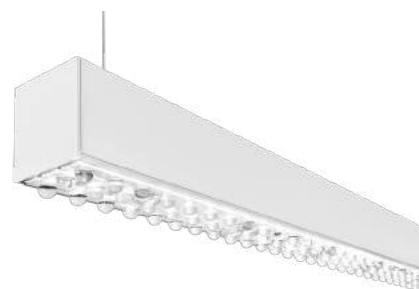
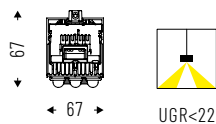

Cod. 4000K	W	lm	L mm
84DAS17K4	17W	2281	575
84DAS24K4	24W	3155	575
84DAS32K4	32W	4563	1149
84DAS45K4	45W	6311	1149
84DAS40K4	40W	5705	1436
84DAS56K4	56W	7889	1436
84DAS77K4	77W	11408	2871
84DAS107K4	107W	15777	2871

Cod. 3000K	W	lm	L mm
84DAS17K3	17W	2200	575
84DAS24K3	24W	3026	575
84DAS32K3	32W	4402	1149
84DAS45K3	45W	6052	1149
84DAS40K3	40W	5502	1436
84DAS56K3	56W	7566	1436
84DAS77K3	77W	11004	2871
84DAS107K3	107W	15130	2871

VECTOR^{SPOT ZOOM MEDIUM}

Accessories on page 54.

IP 40

Polycarbonate lens.

Adjustable beam angles from 25° to 60°.

End caps not included.

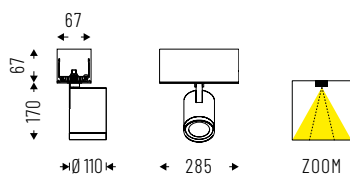

Cod. 4000K	W	lm	L mm
84ZM18K4M	18W	2182	286
84ZM25K4M	25W	3031	286
84ZM33K4M	33W	3380	286

Cod. 3000K	W	lm	L mm
84ZM18K3M	18W	2040	286
84ZM25K3M	25W	2833	286
84ZM33K3M	33W	3130	286

VECTOR SPOT MEDIUM FOOD

Accessories on page 54.

IP 40

Polycarbonate lens. Beam angles 10° -20° -40° -70°.

End caps not included.

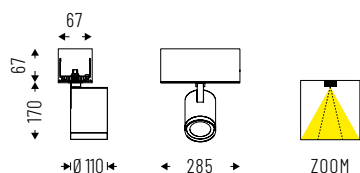

Cod. BREAD	Icon	lm	L mm
84VT38BR10M	38W 10° BREAD	2366	286
84VT38BR20M	38W 20° BREAD	2366	286
84VT38BR40M	38W 40° BREAD	2366	286
84VT38BR70M	38W 70° BREAD	2366	286
84VT54BR10M	54W 10° BREAD	3537	286
84VT54BR20M	54W 20° BREAD	3537	286
84VT54BR40M	54W 40° BREAD	3537	286
84VT54BR70M	54W 70° BREAD	3537	286

Cod. MEAT	Icon	lm	L mm
84VT38MT10M	38W 10° MEAT	1788	286
84VT38MT20M	38W 20° MEAT	1788	286
84VT38MT40M	38W 40° MEAT	1788	286
84VT38MT70M	38W 70° MEAT	1788	286
84VT54MT10M	54W 10° MEAT	2516	286
84VT54MT20M	54W 20° MEAT	2516	286
84VT54MT40M	54W 40° MEAT	2516	286
84VT54MT70M	54W 70° MEAT	2516	286

Cod. FISH	Icon	lm	L mm
84VT38FH10M	38W 10° FISH	2628	286
84VT38FH20M	38W 20° FISH	2628	286
84VT38FH40M	38W 40° FISH	2628	286
84VT38FH70M	38W 70° FISH	2628	286

Cod. FISH	Icon	lm	L mm
84VT54FH10M	54W 10° FISH	3857	286
84VT54FH20M	54W 20° FISH	3857	286
84VT54FH40M	54W 40° FISH	3857	286
84VT54FH70M	54W 70° FISH	3857	286

SPECIALIZED LED MODULES - FOOD



Premium CRI >90 luminaires with 3000K and 4000K color temperatures that **enhance the color of natural products** and are therefore suitable for the lighting of fruits, vegetables and food departments:

- **BREAD:** brown shades appear sharper and brighter, with golden reflexes. Cheeses and other ingredients used in baked goods such as pizza and sandwiches get enhanced in their colors.
- **MEAT / FRESH MEAT:** red tones are extraordinarily stronger, for a fresh and inviting presentation of red and cured meats.
- **FISH:** colors are lively and attractive, the fish looks bright and colorful; the cold shades of light enhance the freshness and brilliance of the fish.

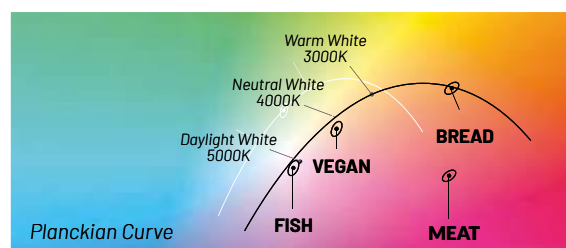

ACCESSORIES



End caps kit.
(5 mm thickness already included in the product length).

84AA09



Single adjustable suspension kit.
Length: 1500 / 3000mm.

84AA13
84AA1330



Linear joint.

84AA11



3 - 5 poles ceiling power supply box.
Cable length 2000mm

00AA165P
00AA167P



Blind connection module in aluminum, adaptable to size on site.

84MC500C 500mm
84MC1000C 1000mm

VECTOR SPOT OPTICS



VECTOR SPOT MEDIUM transparent glass optics.

84AAVTM



VECTOR SPOT MEDIUM frosted glass optics.

84AAMGM



VECTOR SPOT MEDIUM micro engraved optics.





84AASLM









VECTOR SPOT MEDIUM honeycomb optics.

84AANDM

FEATURES

-  Direct emission
-  Direct/Indirect emission
-  UGR < 22; < 16
-  IP 40

LED

-  2700K / 3000K / 3500K
4000K / 5000K
TW / RGBW / DTW
-  >100lm/W
-  CRI >90
-  Eye safety: RG0/RG1
-  Mac Adams 3
-  L80/B10 >50.000h

CERTIFICATIONS

-  EEA Conformity
-  Energy efficiency
-  5 years warranty

ON REQUEST

-  DALI - code D*
-  Bluetooth - code BT*
-  Emergency 1 hr - code EM*
Emergency 3 hrs - code EM3R*

SPECIFICATIONS

DK technology for UGR controlled with UGR <16.
PG diffuser for homogeneous emission with UGR <22.
DU diffuser for homogeneous emission Down & Up UGR <22.

BODY

Aluminum with epoxy powder coating.

COLORS

Matte white RAL 9003 - code B
Matte black RAL 9005 - code C8



ENDO

ENDO is the latest addition to the range of Esse-Ci profiles: **extremely versatile** with a **fully customizable** configuration. The minimal design makes it the best linear lighting solution for **integrating light in architectural structures**, while the perfect mix of performance and the housing versatility of the LED strip allows direct, indirect or asymmetrical emission. Thanks to the **numerous accessories**, such as blind modules, mini spotlights and special joints, **ENDO** allows to create countless configurations of endless light lines, whether they are recessed, ceiling mounted or suspended.

ID 55



* Where available

ENDO^{PG}

Aluminum profile with satin methacrylate diffuser for homogeneous emission, UGR <22.

End caps not included.

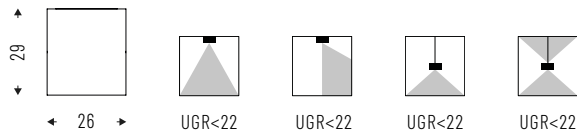

Cod	mm
55PG500	500
55PG1000	1000
55PG2000	2000
55PG3000	3000

- Profile and diffuser can be cut at the desired length.
Example: **750mm** - code: 55PG**750** / **2012mm** - code: 55PG**2012**

COMPATIBLE **FLEX STRIP LED** ON PAGE 67

Accessories on page 59.

IP 40



ENDO^{DU}

Aluminum profile with protruding satin methacrylate diffuser for homogeneous emission, UGR <22.

End caps not included.

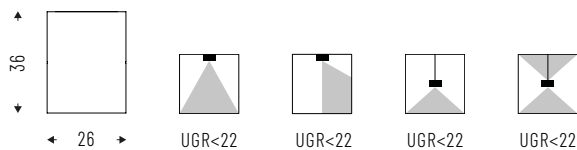

Cod	mm
55DU500	500
55DU1000	1000
55DU2000	2000
55DU3000	3000

- Profile and diffuser can be cut at the desired length.
Example: **750mm** - code: 55DU**750** / **2012mm** - code: 55DU**2012**

COMPATIBLE **FLEX STRIP LED** ON PAGE 67

Accessories on page 59.

IP 40



ENDO^{DK}

Accessories on page 59.

IP 40

Element with microcell optics for controlled UGR <16.

End caps not included.

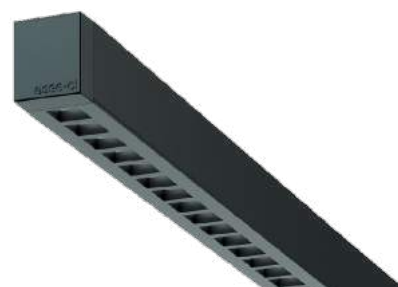
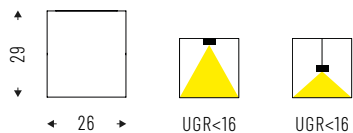

Cod. 4000K	Icon	lm	mm
55DK7K4	7W	900	255
55DK14K4	14W	1800	515
55DK21K4	21W	2700	772
55DK28K4	28W	3600	1030
55DK35K4	35W	4500	1290

Cod. 3000K	Icon	lm	mm
55DK7K3	7W	830	255
55DK14K3	14W	1660	515
55DK21K3	21W	2490	772
55DK28K3	28W	3300	1030
55DK35K3	35W	4150	1290

ENDO^{CI}

Profile for frameless recessed installation, compatible with Endo PG / DU / DK.

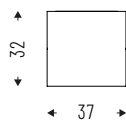

Cod	mm
55AA500CI	500
55AA1000CI	1000
55AA2000CI	2000
55AA3000CI	3000

RECESSED INSTALLATION

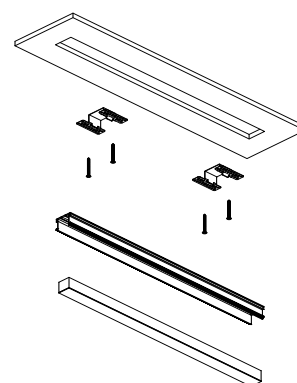

ENDO SPOT ^{DIRECT}

IP 40

Lens with adjustable beam: from 10° to 40°.
Attachment on Endo's lower body part included.

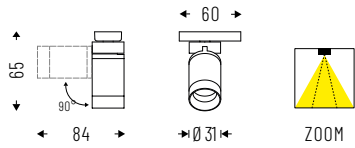

Cod. 4000K	☼	lm
55ZM3K4	3W	262

Cod. 3000K	☼	lm
55ZM3K3	3W	238



ENDO SPOT ^{INDIRECT}

IP 40

Lens with adjustable beam: from 10° to 40°.
Attachment on Endo's upper body part included.

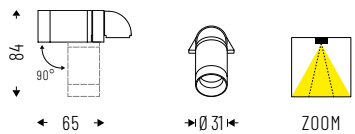

Cod. 4000K	☼	lm
55ZM3K4IN	3W	262

Cod. 3000K	☼	lm
55ZM3K3IN	3W	238



ACCESSORIES



ALL VERSIONS / DU



Ceiling mount kit,
2 pieces.

55AA14



Adjustable suspension
cable. Length 1500mm /
3000mm.

55AA13
55AA1330



Vertical joint 90°.

55AA05V



Linear joint.

55AA11



Ceiling power supply
case for drivers (pg. 69)
2000mm power cables.

55AA16



Recessed ceiling mount
for driver (pg. 69).
2000mm power cables.

55AA16R



Blind screen module,
White or Black.

55MC1000
55MC2000
55MC3000



DU optics end cap.

55AA09DU

FOR STANDARD PG / DK OPTICS ONLY



End cap.

55AA09



2-ways joint.

55AA05Q



3-ways joint.

55AA06Q



4-ways joint.

55AA07Q



Curved joint. 90° - R.145mm
Standard PG screen included.

55AA05PGC

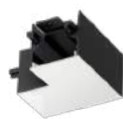

Horizontal joint.
(90°)

55AA05PGO



2-ways "V" joint.
(120°)

55AA05EV



3-ways "Y" joint.
(120°)

55AA06EY

TECHNICAL NOTES





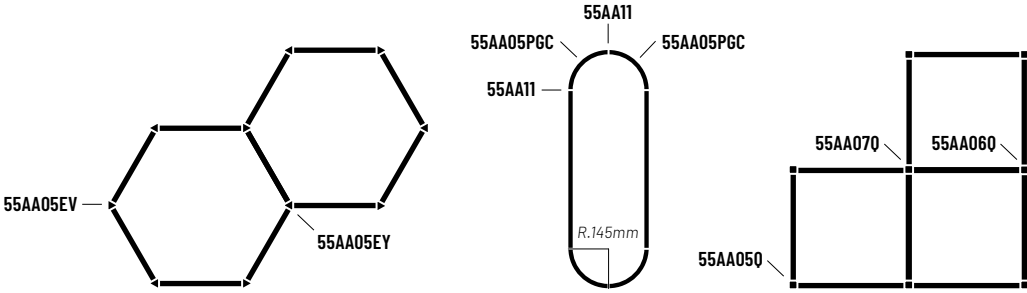

EXAMPLES OF POSSIBLE CONFIGURATIONS









CONFIGURATION EXAMPLE



FEATURES

-  Direct emission
-  Direct/Indirect emission
-  UGR <22
-  IP 20; 40



LED

-  2700K / 3000K / 4000K / 5000K / TW / RGBW / DTW
-  >100 lm/W
-  CRI >90
-  Eye safety: RG0/RG1
-  Mac Adams 3
-  L80/B10 >50.000h

CERTIFICATIONS

-  EEA Conformity
-  Energy efficiency
-  5 years warranty

ON REQUEST

-  DALI - code D
-  Emergency 1 hr - code EM*
Emergency 3 hrs - code EM3R*
-  5000K - code K5*

SPECIFICATIONS

Driver and modules in 24V voltage.
Luminaire with end caps included.
Profile and LED Strip can be cut every 5cm.
Homogeneous extruded satin methacrylate screen UGR <22.

BODY

Aluminum with epoxy powder coating.

COLORS

Matte white RAL 9003 - code B
Matte black RAL 9005 - code C8



PROFREEL is a fixture series for ceiling, suspension or frameless recessed mounting, **fully customizable directly on site**. The device consists of an aluminum body supplied in lengths of up to 3 meters, electronic components (driver and LED strip), that can be selected according to the site needs. The PG methacrylate diffuser is supplied in a 10m coil to be measured and cut on site to realize bright **lines of perfectly homogeneous light without interruptions**. **PROFREEL** allows the application of LED strip even on top of the profile, to achieve bi-directional light distribution. The possibility to integrate the driver inside of the lamp body is its main advantage: this way the installation is simplified and the aesthetics improved.

ID 83



* Where available

PROFREEL IS

IP 40

Antistatic satin methacrylate diffuser screen,
UGR <22.

Luminaire complete with 10 W / m strip, heads and converter.
Fixing accessories to be ordered separately.



Cod. 4000K	Icon	Im	L mm
83PG6K4	5.5W	529	578
83PG8K4	8W	769	848
83PG11K4	11W	1058	1128
83PG14K4	13.5W	1298	1408
83PG17K4	16.5W	1586	1688
83PG25K4	25W	2404	2530
83PG31K4	30.5W	2932	3090

Cod. 3000K	Icon	Im	L mm
83PG6K3	5.5W	457	578
83PG8K3	8W	664	848
83PG11K3	11W	914	1128
83PG14K3	13.5W	1121	1408
83PG17K3	16.5W	1371	1688
83PG25K3	25W	2077	2530
83PG31K3	30.5W	2534	3090

Cod. 2700K	Icon	Im	L mm
83PG6K27	5.5W	428	578
83PG8K27	8W	622	848
83PG11K27	11W	856	1128
83PG14K27	13.5W	1050	1408

Cod. 2700K	Icon	Im	L mm
83PG17K27	16.5W	1282	1688
83PG25K27	25W	1944	2530
83PG31K27	30.5W	2371	3090

PROFREEL

Aluminum profile for ceiling, suspension and recessed applications.

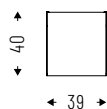

Cod.	L mm
83AA1000	1000
83AA2000	2000

Cod.	L mm
83AA2700	2700
83AA3000	3000

COMPATIBLE FLEX STRIP LED ON PAGE 67

ACCESSORIES



CLD screen,
(collimated optics UGR <16)
1000mm / 2000mm / 3000mm

83CLD1000
83CLD2000
83CLD3000



PG screen,
(UGR <22) 1000mm /
2000mm / 3000mm

83PG1000
83PG2000
83PG3000



Semi-opaque
PMMA indirect film.
1200mm length.

83IN1000



CLD screen,
(collimated optics UGR <16)
10m roll for cutting to length
on continuous lines without
interruptions.

83CLD10000



PG screen,
(UGR <22) 10m roll for cutting
to length on continuous lines
without interruptions.

83SC10000



Adjustable suspension
kit. Cable length
1500mm / 3000mm.

83AA13
83AA1330



Ceiling installation kit.

83AA14



3 - 5 poles ceiling
power supply box.
Cable length 2000mm.

00AA16
00AA165P

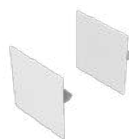

End caps kit.
(3mm thickness included
in the product length).

83AA09



Linear joint.

83AA11



Brackets kit for
recessed installation.

83AA17

TECHNICAL NOTES



PROFREEL lets full freedom to customize both the length and the luminous shapes you want to create. Horizontal and vertical angles are obtained with extreme simplicity by sectioning the profile and the diffuser directly on site.

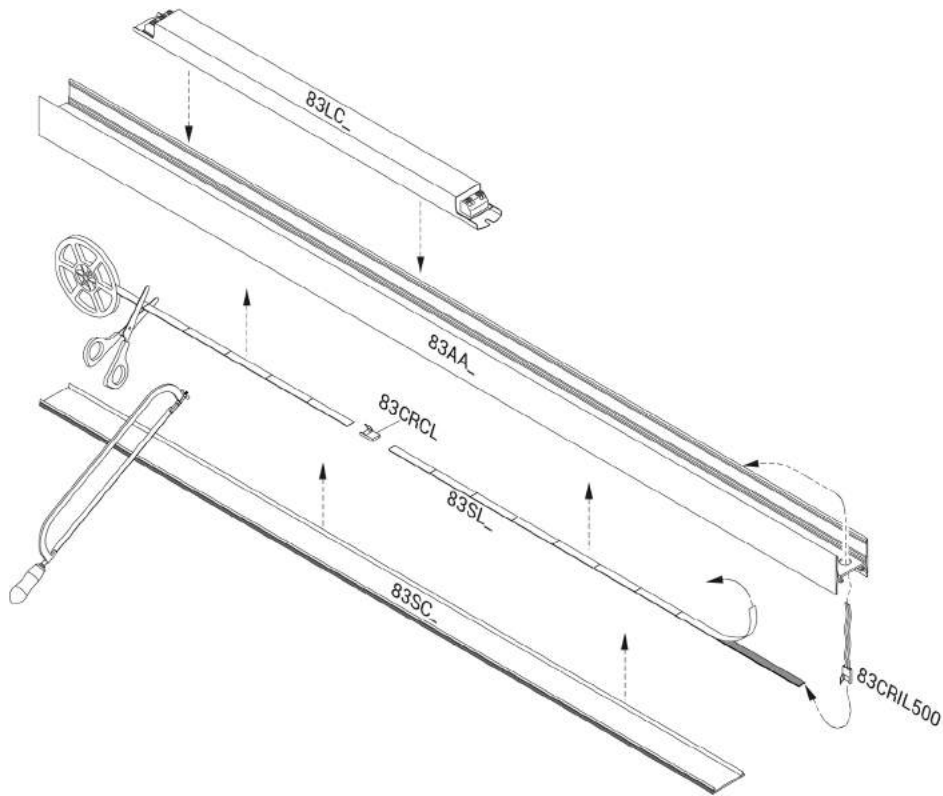

FEW EASY STEP

- Define and select the length of the system
- Choose the power / flux and the type of LED Strip
- Match the correct driver and linking connectors
- Choose the diffuser and accessories for installation

INSTALLATION EXAMPLES

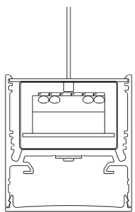

SUSPENSION

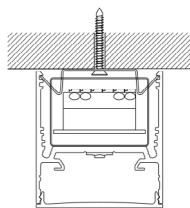

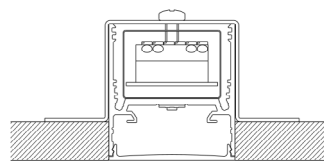

CEILING









RECESSED

FEATURES

-  Direct emission
-  UGR <22
-  IP 40



LED

-  2700K / 3000K / 4000K / 5000K / TW / RGBW / DTW
-  >100 lm/W
-  CRI >90
-  Eye safety: R60/R61
-  Mac Adams 3
-  L80/B10 >50.000h

CERTIFICATIONS

-  EEA Conformity
-  Energy efficiency
-  5 years warranty

ON REQUEST

-  DALI - code D*
-  Emergency 1 hr - code EM*
Emergency 3 hrs - code EM3R*

SPECIFICATIONS

SMD LED technology
on 24V adhesive strip.
Satin methacrylate diffuser for
homogeneous emission UGR <22.

BODY

Anodized aluminum



PROFREEL, the fully customizable line of luminaires for continuous rows, is enriched with a new version that makes installation even faster and more precise: **PROFREEL SLIM**. Characterized by a **T-section** that covers any imperfections of the cut, it allows the application of thin blades of light quickly and easily. **PROFREEL SLIM** is available in two variants: the **DISPLAY** version, ready for installation, and the **FREE** version, which can be customized directly on site.

ID 83



* Where available

PROFREEL SLIM ^{DISPLAY}

IP 40

PG diffuser in extruded opal PMMA for homogeneous emission UGR <22.



Cod. 4000K	Icon	lm	L mm
83P05K4	5W	385	516
83P09K4	9W	516	516
83P011K4	11W	647	516
83P08K4	8W	616	816
83P012K4	12W	826	816
83P016K4	16W	1036	816
83P010K4	10W	770	1016
83P017K4	17W	1033	1016
83P021K4	21W	1295	1016
83P015K4	15W	1155	1516
83P023K4	23W	1549	1516
83P031K4	31W	1942	1516
83P020K4	20W	1540	2016
83P030K4	30W	2065	2016
83P040K4	40W	2590	2016

Cod. 3000K	Icon	lm	L mm
83P05K3	5W	368	516
83P09K3	9W	493	516
83P011K3	11W	619	516
83P08K3	8W	589	816
83P012K3	12W	790	816
83P016K3	16W	990	816
83P010K3	10W	736	1016
83P017K3	17W	987	1016
83P021K3	21W	1238	1016
83P015K3	15W	1104	1516
83P023K3	23W	1480	1516
83P031K3	31W	1857	1516
83P020K3	20W	1472	2016
83P030K3	30W	1974	2016
83P040K3	40W	2476	2016

PROFREEL SLIM ^{FREE}

Aluminum profile for recessed applications that can be sectioned at will, complete with PG screen, end caps and spring kit.

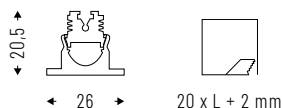

COD	L mm
83P01000	1000
83P02000	2000
83P03000	3000

COMPATIBLE **FLEX STRIP LED** ON PAGE 67

FEATURES

 IP20; IP65

LED

 2700K/3000K/4000K/5000K
TW - RGBW - DTW

 >100 lm/W

 CRI >90

 Eye safety: RGO

 Mac Adams 3

 L80/B10 >50.000h

CERTIFICATIONS

 EEA Conformity

 Energy efficiency

 5 years warranty



FLEX STRIP LED

Our range of **FLEX STRIP LED**, flexible and adhesive, is available in a wide choice of color temperatures: Tunable White, Dim to Warm or RGBW. Sectionable every 50mm, the strips are compatible with high quality drivers and controllers for effective light management.

ID 83



STRIP LED IP 20

Accessories on page 70.

IP 20

Adhesive LED strip 24V CRI> 90.

Length: 5000 mm - sectionable every 50mm.

Cod. 2700K		lm / m	mm
83SL10K27	10W/mt	818	5000
83SL15K27	15W/mt	1228	5000
83SL20K27	20W/mt	1637	5000
83SL24K27	24W/mt	2009	5000



Cod. 3000K		lm / m	mm
83SL10K3	10W/mt	880	5000
83SL15K3	15W/mt	1320	5000
83SL20K3	20W/mt	1760	5000
83SL24K3	24W/mt	2160	5000

Cod. 4000K		lm / m	mm
83SL10K4	10W/mt	941	5000
83SL15K4	15W/mt	1412	5000
83SL20K4	20W/mt	1883	5000
83SL24K4	24W/mt	2311	5000

STRIP LED IP 65

Accessories on page 70.

IP 65

Adhesive LED strip 24V CRI> 90.

Length: 5000 mm - sectionable every 50mm.

Cod. 2700K		lm / m	mm
83SL10K27IP65	10W/mt	735	5000
83SL15K27IP65	15W/mt	1023	5000

Cod. 4000K		lm / m	mm
83SL10K4IP65	10W/mt	845	5000
83SL15K4IP65	15W/mt	1177	5000

Cod. 3000K		lm / m	mm
83SL10K3IP65	10W/mt	790	5000
83SL15K3IP65	15W/mt	1100	5000

Cod. 5000K		lm / m	mm
83SL10K5IP65	10W/mt	904	5000
83SL15K5IP65	15W/mt	1259	5000

STRIP LED TUNABLE WHITE

Cod. 2700/6500K		lm / m	mm
83SL24TW	24W/mt	2240	5000

STRIP LED DIM TO WARM

Cod. 1800/3000K		lm / m	mm
83SL24DTW	24W/mt	2160	5000

STRIP LED RGBW

Cod.		lm / m	mm
83SL17RGW	17W/mt	1170	5000

STRIP LED RGBW IP65

Cod.		lm / m	mm
83SL17RGWIP65	17W/mt	1050	5000

DRIVER

Accessories on page 70.

IP 20

Driver to be selected according to the power and length of the installed LED strip.

INDEPENDENT INSTALLATION CONVERTER (IS) - ON/OFF

Cod.	
83LC6024IS	24V 60W
83LC12024IS	24V 120W
83LC20024IS	24V 200W

• Compatible products: **PROFREEL - ENDO**

INDEPENDENT INSTALLATION CONVERTER (IS) - DALI

Cod.	
83LC6024ISD	24V 60W
83LC10024ISD	24V 100W
83LC15024ISD	24V 150W

• Compatible products: **PROFREEL - ENDO**

INDEPENDENT INSTALLATION CONVERTER SLIM - ON/OFF

Cod.	
83LC6024SIS	24V 60W
83LC10024SIS	24V 100W

• Compatible products: **PROFREEL SLIM DISPLAY**

LINEAR CONVERTER 30X21mm - ON/OFF

Cod.	
83LC6024	24V 60W
83LC10024	24V 100W

• Compatible products: **PROFREEL**

REMOTE INSTALLATION

HOUSED INSIDE THE PROFILE



INDEPENDENT INSTALLATION CONVERTER (IS) - BLUETOOTH

Cod.	
83LC6024ISBT	24V 60W
83LC10024ISBT	24V 100W
83LC15024ISBT	24V 150W

• Compatible products: **PROFREEL - ENDO**

INDEPENDENT INSTALLATION CONVERTER SLIM - DALI

Cod.	
83LC7024SISD	24V 70W
83LC12024SISD	24V 120W

• Compatible products: **PROFREEL SLIM DISPLAY**

LINEAR CONVERTER 30X21mm - DALI

Cod.	
83LC6024D	24V 60W
83LC10024D	24V 100W

• Compatible products: **PROFREEL**

CONTROLLER BASIC

Cod.	Note
DIMKITTW	Tunable White + Remote



Cod.	Note
DIMKITRGBW	RGBW + Remote



CONTROLLER DALI RGBW/TW

Cod.	Note
83CL4X1D	DALI RGBW / Tunable White



ACCESSORIES



Start-of-line connector
IP20

- 83AA09EL** - IP20 / Dim to Warm
- 83AA09ELRGB** - RGBW
- 83AA09ELTW** - Tunable White



Start-of-line connector
IP65

- 83AA09ELIP** - IP65
- 83AA09ELIPRGB** - RGBW IP65



Strip-Strip linear junction
IP20

- 83AA11SL** - IP20 / Dim to Warm
- 83AA11RGB** - RGBW
- 83AA11TW** - Tunable White



Strip-Strip linear junction
IP65

- 83AA11IP** - IP65
- 83AA11IPRGB** - RGBW IP65



Wired linear junction
IP20

- 83AA11CC150** - IP20 / Dim to Warm
- 83AA11CC150RGB** - RGBW
- 83AA11CC150TW** - Tunable White



Wired linear junction
IP65

- 83AA11CC150IP** - IP65
- 83AA11CC150IPRGB** - RGBW IP65

FEATURES

 Direct emission

 UGR <16

 IP 40

LED

 3000K/4000K

 >107 lm/W

 CRI >90

 Eye safety: R60/R61

 Mac Adams 3

 L80/B10 >50.000h

CERTIFICATIONS

 EEA Conformity

 Energy efficiency

 5 years warranty

ON REQUEST

 DALI - code D

 Bluetooth - code BT*

 Emergency 1 hr - code EM*
Emergency 3 hrs - code EM3R*

 2700K - code K27*

SPECIFICATIONS

Built-in driver.
High Contrast UGR <16 diffuser.

BODY

Aluminum with epoxy
powder coating.

COLORS

White RAL 9003 - code B
Black RAL 9005 - code C8

RELATED PRODUCTS

Wave (P. 100)



WAVE DISPLAY was created as a recessed element for single installation or in continuous rows. As for **WAVE**, the Direct emission with **High Contrast microcell optical system** is characterized by the high glare control.

ID 85

WAVE DISPLAY

IP 40

High contrast diffuser UGR<16.

End caps not included.

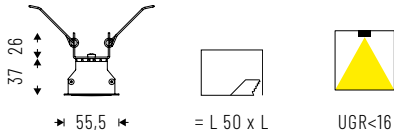

Cod. 4000K	Icon	lm	L mm
85DR9DKK4R	9W	965	281
85DR18DKK4R	18W	1926	561
85DR36DKK4R	36W	3852	1121

Cod. 3000K	Icon	lm	L mm
85DR9DKK3R	9W	897	281
85DR18DKK3R	18W	1791	561
85DR36DKK3R	36W	3582	1121

WAVE DISPLAY⁹⁰

IP 40

High contrast diffuser UGR<16.

End caps not included.

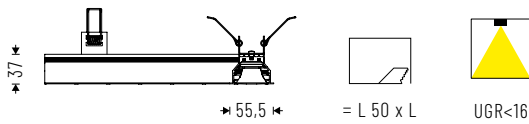

Cod. 4000K	Icon	lm	L mm
85DR18DKK4A90R	18W	1926	288x388

Cod. 3000K	Icon	lm	L mm
85DR18DKK3A90R	18W	1791	288x388

ACCESSORIES



End caps kit for recessed version. (Consider + 4 mm on the cutting length).

85AA09R



Linear joint for recessed version.



85AA11R









Blind module in aluminum with linear joints included.

85MC500R
85MC1000R

FEATURES

-  Direct emission
-  UGR <22
-  IP 40

LED

-  3000K/4000K
-  >98 lm/W
-  CRI >90
-  Eye safety: R60/R61
-  Mac Adams 3
-  L80/B10 >50.000h

CERTIFICATIONS

-  EEA Conformity
-  Energy efficiency
-  5 years warranty

ON REQUEST

-  DALI - code D
-  Bluetooth - code BT*
-  Emergency 1 hr - code EM
Emergency 3 hrs - code EM3R*
-  2700K - code K27*
5000K - code K5*
-  Human Centric Lighting*

SPECIFICATIONS

Built-in driver.
Diffuser in extruded PMMA for soft emission without shadow areas.

BODY

Aluminum with epoxy powder coating.

COLORS

Matte white RAL 9003 - code B
Matte black RAL 9005 - code C8



OVVIO DISPLAY LED is the recessed luminaire for plasterboard ceilings with a **compact design** and a **framebit of 4mm**. Fastening system and quick electrical connection facilitate the installation. Low and high power LED modules allow to always find the best lighting solution. The maximum length of the profiles is over three metres, with a 280mm modularity and corner elements for wall or ceiling mount.

ID 40



* Where available

OVVIO DISPLAY LED LOW POWER

IP 40

Diffuser in extruded PMMA (UGR <22) for soft emission without shadow areas.

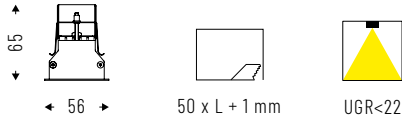

Cod. 4000K	☼	L mm	lm	L mm
40PG18K4	18W	844	1770	872
40PG24K4	24W	1124	2360	1152
40PG30K4	30W	1404	2951	1432
40PG36K4	36W	1684	3540	1712
40PG42K4	42W	1964	4130	1992
40PG48K4	48W	2244	4721	2272
40PG54K4	54W	2524	5310	2552
40PG60K4	60W	2804	5900	2832
40PG66K4	66W	3084	6490	3112

Cod. 3000K	☼	L mm	lm	L mm
40PG18K3	18W	844	1733	872
40PG24K3	24W	1124	2310	1152
40PG30K3	30W	1404	2888	1432
40PG36K3	36W	1684	3465	1712
40PG42K3	42W	1964	4043	1992
40PG48K3	48W	2244	4621	2272
40PG54K3	54W	2524	5198	2552
40PG60K3	60W	2804	5776	2832
40PG66K3	66W	3084	6354	3112

OVVIO DISPLAY LED HIGH POWER

IP 40

Diffuser in extruded PMMA (UGR <22) for soft emission without shadow areas.

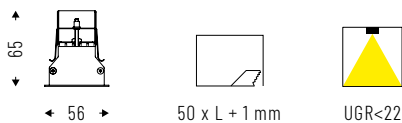

Cod. 4000K	☼	L mm	lm	L mm
40PG48K4HP	48W	1124	4719	1152
40PG60K4HP	60W	1404	5900	1432
40PG72K4HP	72W	1684	7080	1712

Cod. 3000K	☼	L mm	lm	L mm
40PG48K3HP	48W	1124	4621	1152
40PG60K3HP	60W	1404	5776	1432
40PG72K3HP	72W	1684	6931	1712

ACCESSORIES



End caps kit.
(Consider + 4 mm on
the cutting length).

40AA09LED



Linear joint.

40AA11LED



PG screen (UGR < 22)
in 10 m roll to be cut to measure
for continuous lines without
interruptions.

40PG10000



GROOVE DISPLAY

GROOVE DISPLAY is the technical solution adopted for an **easy and precise installation**. It is an easy-to-manage lighting system, from the design stage to the installation of the product in continuous rows. The ideal fixture for recessed mounting on plasterboard and slatted ceilings.





ID 43



FEATURES

-  Direct emission
-  UGR <19
-  IP 40







LED

-  3000K/4000K
- >105 lm/W icon" data-bbox="753 235 788 255"/> >105 lm/W
-  CRI >90
-  Eye safety: R60/R61
-  Mac Adams 3
-  L80/B10 >50.000h

CERTIFICATIONS

-  EEA Conformity
-  Energy efficiency
-  5 years warranty

ON REQUEST

-  DALI - code D
-  Bluetooth - code BT*
-  Emergency 1 hr - code EM
-  Emergency 3 hrs - code EM3R*
-  2700K - code K27*
-  5000K - code K5*
-  HCL Human Centric Lighting*

SPECIFICATIONS

Built-in driver.
Diffuser with DPL UGR <19 technology for environments with video terminal.

BODY

Aluminum with epoxy powder coating.

COLORS

Matte white RAL 9003 - code B
Matte black RAL 9005 - code C8

RELATED PRODUCTS

Groove (P. 33)
Groove IP54 (P. 268)
Groove Display IP54 (P. 271)

* Where available

GROOVE DISPLAY LOW POWER

Accessories on page 78.

IP 40

Diffuser with Diamond Prism LED technology (UGR <19)
for environments with display screen equipment.

End caps not included.

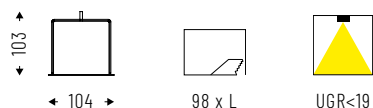

Cod. 4000K	W	lm	L mm
43DPL24K4F	24W	2646	1130
43DPL30K4F	30W	3308	1410
43DPL36K4F	36W	3969	1690
43DPL42K4F	42W	4631	1970
43DPL48K4F	48W	5292	2250
43DPL54K4F	54W	5954	2530
43DPL60K4F	60W	6615	2810
43DPL66K4F	66W	7277	3090

Cod. 3000K	W	lm	L mm
43DPL24K3F	24W	2460	1130
43DPL30K3F	30W	3077	1410
43DPL36K3F	36W	3691	1690
43DPL42K3F	42W	4306	1970
43DPL48K3F	48W	4921	2250
43DPL54K3F	54W	5537	2530
43DPL60K3F	60W	6152	2810
43DPL66K3F	66W	6767	3090

GROOVE DISPLAY HIGH POWER

Accessories on page 78.

IP 40

Diffuser with Diamond Prism LED technology (UGR <19)
for environments with display screen equipment.

End caps not included.

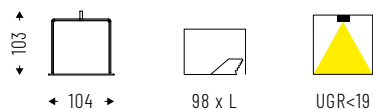

Cod. 4000K	W	lm	L mm
43DPL45K4HPF	45W	4961	1130
43DPL57K4HPF	57W	6284	1410
43DPL68K4HPF	68W	7497	1690

Cod. 3000K	W	lm	L mm
43DPL45K3HPF	45W	4614	1130
43DPL57K3HPF	57W	5844	1410
43DPL68K3HPF	68W	6972	1690

ACCESSORIES



End caps kit.
(Consider + 4 mm on
the cutting length).

43AA09F



Linear joint.

43AA11F



PG screen (UGR < 22)
in 10 m roll to be cut to
measure for continuous
lines without interruptions.

43PG10000

SUSPENDED / CEILING



C
H
A
P
T
E
R

T
W
O

One Ring	80	ID17
Ben	84	ID10
Pipe Line	91	ID86
Pipe Line Mono	94	ID86
Jools	96	ID11
Stylo	98	ID88
Wave	100	ID85
Dimples	102	ID48
Lite	109	ID47







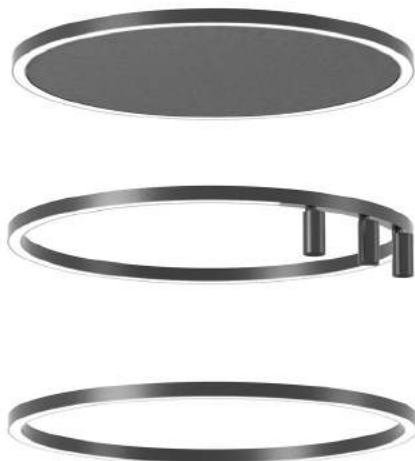

ONE RING

ONE RING is a **decorative yet highly technical fixture** with a minimal design and multiple application possibilities. Available in a range of diameters, for direct ceiling or suspended mounting, with direct or direct/indirect light emission and the possibility of adding adjustable spotlights for accent lighting. With the option of including a central acoustic with sound absorption panels, **ONE RING** is a truly unique lighting solution.







ID 17



FEATURES

-  Direct emission
-  Direct/Indirect emission
-  UGR <22; <19
-  IP 40





LED

-  3000K/4000K
-  >107 lm/W
-  CRI >90
-  Eye safety: R60/R61
-  Mac Adams 3
-  L80/B10 >50.000h

CERTIFICATIONS

-  EEA Conformity
-  Energy efficiency
-  Energy efficiency per versione SPOT
-  5 years warranty

ON REQUEST

-  DALI - code D*
-  Bluetooth - code BT*
-  Emergency 1 hr - code EM*
Emergency 3 hrs - code EM3R*
-  Ceiling version*
-  2700K - code K27*

SPECIFICATIONS

Satin methacrylate diffuser for homogeneous emission UGR<22. Impact resistant DPL diffuser with homogeneous and controlled emission, UGR<19.

BODY

Aluminum with epoxy powder coating.

COLORS

White RAL 9003 - code B
Black RAL 9005 - code C8

* Where available

ONE RING^{PG}

Accessories on page 83.

IP 40

Satin methacrylate diffuser for homogeneous emission UGR <22.

Power supply box and suspensions (L. 3000mm) included.

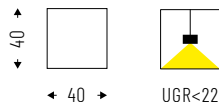

Cod. 4000K	W	lm	Ø mm
17PG39K4	39W	4173	790
17PG58K4	58W	6216	1140
17PG77K4	77W	8288	1510
17PG96K4	96W	10360	1860
17PG115K4	115W	12432	2240
17PG134K4	134W	14504	2592
17PG154K4	154W	16576	2960

Cod. 3000K	W	lm	Ø mm
17PG39K3	39W	3881	790
17PG58K3	58W	5780	1140
17PG77K3	77W	7708	1510
17PG96K3	96W	9635	1860
17PG115K3	115W	11562	2240
17PG134K3	134W	13489	2592
17PG154K3	154W	15416	2960

For "ceiling" version with remote driver add "P" to the code.

ONE RING^{PG DOUBLE EMISSION}

Accessories on page 83.

IP 40

Satin methacrylate diffuser for homogeneous emission UGR <22. Direct / Indirect emission.

Power supply box and suspensions (L. 3000mm) included.

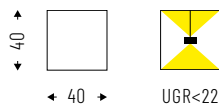

Cod. 4000K	W	lm	Ø mm
17DI63PGK4	63W: 39W+24W	6057	790
17DI93PGK4	93W: 58W+35W	8966	1140
17DI123PGK4	123W: 77W+46W	11588	1510
17DI153PGK4	153W: 96W+57W	14760	1860
17DI184PGK4	184W: 115W+69W	17382	2240
17DI215PGK4	215W: 134W+81W	20554	2592
17DI246PGK4	246W: 154W+92W	23726	2960

Cod. 3000K	W	lm	Ø mm
17DI63PGK3	63W: 39W+24W	5578	790
17DI93PGK3	93W: 58W+35W	8255	1140
17DI123PGK3	123W: 77W+46W	10678	1510
17DI153PGK3	153W: 96W+57W	13595	1860
17DI184PGK3	184W: 115W+69W	16017	2240
17DI215PGK3	215W: 134W+81W	18934	2592
17DI246PGK3	246W: 154W+92W	21851	2960

For ceiling version with remote driver add "P" to the code.

ONE RING^{DPL}

IP 40

Diffuser with Diamond Prism LED (DPL) technology with UGR <19 for environments with display screen equipment.

Power supply box and suspensions (L. 3000mm) included.

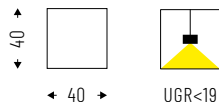

Cod. 4000K	☼	lm	Ø mm
17DPL39K4	39W	3950	790
17DPL58K4	58W	5880	1140
17DPL77K4	77W	7840	1510
17DPL96K4	96W	9800	1860
17DPL115K4	115W	11760	2240
17DPL134K4	134W	13720	2592
17DPL154K4	154W	15680	2960

Cod. 3000K	☼	lm	Ø mm
17DPL39K3	39W	3674	790
17DPL58K3	58W	5468	1140
17DPL77K3	77W	7291	1510
17DPL96K3	96W	9114	1860
17DPL115K3	115W	10937	2240
17DPL134K3	134W	12760	2592
17DPL154K3	154W	14582	2960

For ceiling version with remote driver add "P" to the code.

ONE RING^{DPL DOUBLE EMISSION}

IP 40

Diffuser with Diamond Prism LED (DPL) technology with UGR <19 for environments with display screen equipment. Direct/Indirect emission.

Power supply box and suspensions (L. 3000mm) included.

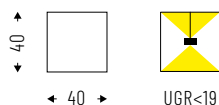

Cod. 4000K	☼	lm	Ø mm
17DI63DPLK4	63W: 39W+24W	5834	790
17DI93DPLK4	93W: 58W+35W	8630	1140
17DI123DPLK4	123W: 77W+46W	11140	1510
17DI153DPLK4	153W: 96W+57W	14200	1860
17DI184DPLK4	184W: 115W+69W	16710	2240
17DI215DPLK4	215W: 134W+81W	19770	2592
17DI246DPLK4	246W: 154W+92W	22830	2960

Cod. 3000K	☼	lm	Ø mm
17DI63DPLK3	63W: 39W+24W	5371	790
17DI93DPLK3	93W: 58W+35W	7943	1140
17DI123DPLK3	123W: 77W+46W	10261	1510
17DI153DPLK3	153W: 96W+57W	13074	1860
17DI184DPLK3	184W: 115W+69W	15392	2240
17DI215DPLK3	215W: 134W+81W	18205	2592
17DI246DPLK3	246W: 154W+92W	21017	2960

For ceiling version with remote driver add "P" to the code.

ONE RING PG ACOUSTIC DOUBLE EMISSION

IP 40

Satin methacrylate diffuser for homogeneous emission UGR <22. Direct / Indirect emission.

Power supply box and suspensions (L. 3000mm) included. Gray sound-absorbing panel.

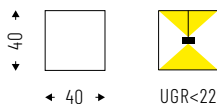

Cod. 4000K		lm	Ø mm
17DI93PGK4AC	93W: 58W+35W	8966	1140

Cod. 3000K		lm	Ø mm
17DI93PGK3AC	93W: 58W+35W	8255	1140

For ceiling version with remote driver add "P" to the code.

ONE RING SPOT

IP 40

Spot light installable on One Ring. Beam angles: 15° - 20° - 36° - 50°.

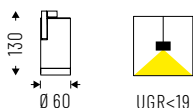

Cod. 4000K		lm	Ø mm
17VT9K415	9W 15°	1094	60
17VT9K420	9W 20°	1094	60
17VT9K436	9W 36°	1094	60
17VT9K450	9W 50°	1094	60

Cod. 3000K		lm	Ø mm
17VT9K315	9W 15°	923	60
17VT9K320	9W 20°	923	60
17VT9K336	9W 36°	923	60
17VT9K350	9W 50°	923	60

ACCESSORIES



Kit of transparent screens for the indirect lighting side.

- 17AASCINTR790** Diam. Ø 790mm
- 17AASCINTR1140** Diam. Ø 1140mm
- 17AASCINTR1510** Diam. Ø 1510mm
- 17AASCINTR1860** Diam. Ø 1860mm

- 17AASCINTR2240** Diam. Ø 2240mm
- 17AASCINTR2592** Diam. Ø 2592mm
- 17AASCINTR2960** Diam. Ø 2960mm







BEN

BEN is the universal luminaire for wall, ceiling, suspension or recessed installation with bodies **made entirely of aluminum**, without welding. The **IP40** version offers both satin and microprismatic diffusers with DPL UGR <19 technology. **The mid-power LED on circular boards avoid the creation of shadow areas** and are connected to the internal supports via quick connectors, for easy electrification.







ID 10





FEATURES

-  Direct emission
-  Direct/Indirect emission
-  UGR <19; <22
-  IP 40





LED

-  3000K/4000K
-  >125 lm/W
-  CRI >125
-  Eye safety: R60/R61
-  Mac Adams 3
-  L80/B10 >50.000h

CERTIFICATIONS

-  EEA Conformity
-  Energy efficiency
-  5 years warranty
-  ETL certification

ON REQUEST

-  DALI - code D
-  Bluetooth - code BT*
-  Emergency 1 hr - code EM*
Emergency 3 hrs - code EM3R*
-  2700K - code K27*
-  HCL - Human Centric Lighting*

SPECIFICATIONS

Built-in driver.
Impact resistant satin acrylic PG diffuser with UGR<22.
Impact resistant DPL diffuser with homogeneous and controlled emission UGR<19 (accessory).

BODY

Aluminum with epoxy powder coating.

COLORS

Matte white RAL 9003 - code B

RELATED PRODUCTS

Ben recessed (P. 124)
Ben wall (P. 249)
Ben IP54 (P. 315)

* Where available

BEN SMALL PG

Accessories on page 10.

IP 40

PG diffuser with frosted Acryl-Satiné and impact resistant diffuser UGR<22.

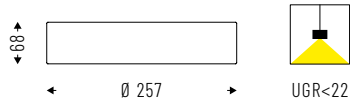

Cod. 4000K	Icon	lm	Ø mm
10PG6K4	6W	749	257
10PG12K4	12W	1497	257
10PG18K4	18W	2246	257

Cod. 3000K	Icon	lm	Ø mm
10PG6K3	6W	712	257
10PG12K3	12W	1422	257
10PG18K3	18W	2138	257

BEN SMALL PG DOUBLE EMISSION

Accessories on page 10.

IP 40

PG diffuser with frosted Acryl-Satiné and impact resistant diffuser UGR<22. Direct / Indirect emission.

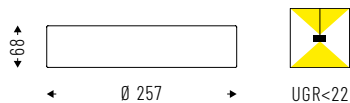

Cod. 4000K	Icon	lm	Ø mm
10DI15PGK4	15W: 6W+9W	1965	257
10DI21PGK4	21W: 15W+9W	2713	257
10DI27PGK4	27W: 18W+9W	3462	257

Cod. 3000K	Icon	lm	Ø mm
10DI15PGK3	15W: 6W+9W	1859	257
10DI21PGK3	21W: 15W+9W	2569	257
10DI27PGK3	27W: 18W+9W	3285	257

BEN MEDIUM PG

Accessories on page 10.

IP 40

PG diffuser with frosted Acryl-Satiné and impact resistant diffuser UGR<22.

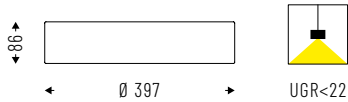

Cod. 4000K	☼	lm	Ø mm
10PG16K4	16W	1994	397
10PG25K4	25W	3113	397

Cod. 3000K	☼	lm	Ø mm
10PG16K3	16W	1894	397
10PG25K3	25W	2957	397

BEN MEDIUM PG DOUBLE EMISSION

Accessories on page 10.

IP 40

PG diffuser with frosted Acryl-Satiné and impact resistant diffuser UGR<22. Direct / Indirect emission.

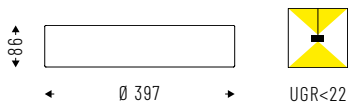

Cod. 4000K	☼	lm	Ø mm
10DI28PGK4	28W: 16W+12W	3616	397
10DI37PGK4	37W: 25W+12W	4735	397

Cod. 3000K	☼	lm	Ø mm
10DI28PGK3	28W: 16W+12W	3424	397
10DI37PGK3	37W: 25W+12W	4487	397

BEN LARGE PG

Accessories on page 10.

IP 40

PG diffuser with frosted Acryl-Satiné and impact resistant diffuser UGR<22.

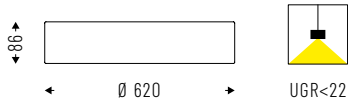

Cod. 4000K	☼	lm	Ø mm
10PG60K4	60W	7476	620
10PG112K4	112W	13955	620

Cod. 3000K	☼	lm	Ø mm
10PG60K3	60W	7102	620
10PG112K3	112W	13257	620

BEN LARGE PG DOUBLE EMISSION

Accessories on page 10.

IP 40

PG diffuser with frosted Acryl-Satiné and impact resistant diffuser UGR<22. Direct / Indirect emission.

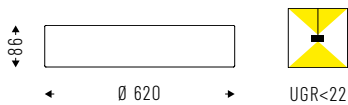

Cod. 4000K	☼	lm	Ø mm
10DI84PGK4	84W: 60W+24W	10689	620
10DI136PGK4	136W: 112W+24W	17168	620

Cod. 3000K	☼	lm	Ø mm
10DI84PGK3	84W: 60W+24W	10131	620
10DI136PGK3	136W: 112W+24W	16286	620

BEN^{XL PG}

Accessories on page 10.

IP 40

PG diffuser with frosted Acryl-Satiné and impact resistant diffuser UGR<22.

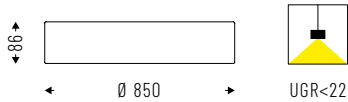

Cod. 4000K	☼	lm	Ø mm
10PG70K4	70W	8722	850
10PG150K4	150W	18690	850

Cod. 3000K	☼	lm	Ø mm
10PG70K3	70W	8286	850
10PG150K3	150W	17756	850

BEN^{XL PG DOUBLE EMISSION}

Accessories on page 10.

IP 40

PG diffuser with frosted Acryl-Satiné and impact resistant diffuser UGR<22. Direct / Indirect emission.

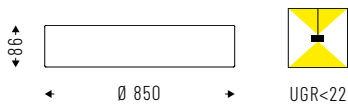

Cod. 4000K	☼	lm	Ø mm
10DI100PGK4	100W: 70W+30W	12738	850
10DI180PGK4	180W: 150W+30W	22706	850

Cod. 3000K	☼	lm	Ø mm
10DI100PGK3	100W: 70W+30W	12072	850
10DI180PGK3	180W: 150W+30W	21542	850

BEN MAXI PG

Accessories on page 10.

IP 40

PG diffuser with frosted Acryl-Satiné and impact resistant diffuser UGR<22.

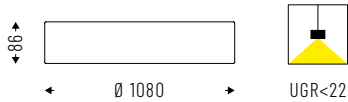

Cod. 4000K	☼	lm	Ø mm
10PG180K4	180W	22428	1080
10PG240K4	240W	29904	1080

Cod. 3000K	☼	lm	Ø mm
10PG180K3	180W	21307	1080
10PG240K3	240W	28409	1080

BEN MAXI PG DOUBLE EMISSION

Accessories on page 10.

IP 40

PG diffuser with frosted Acryl-Satiné and impact resistant diffuser UGR<22. Direct / Indirect emission.

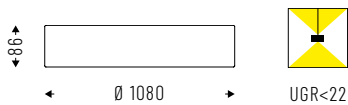

Cod. 4000K	☼	lm	Ø mm
10DI216PGK4	216W: 180W+36W	27248	1080
10DI276PGK4	276W: 240W+36W	34724	1080

Cod. 3000K	☼	lm	Ø mm
10DI216PGK3	216W: 180W+36W	25851	1080
10DI276PGK3	276W: 240W+36W	32953	1080

ACCESSORIES



DPL diffuser for IP40 version.

- 10AADPLS** - SMALL
- 10AADPLM** - BEN MEDIUM
- 10AADPLL** - BEN LARGE
- 10AADPLXL** - BEN XL
- 10AADPLMX** - BEN MAXI



Kit for suspended installation. Cable length 1500/3000 mm.

- 10AA13**
- 10AA1330**



3 - 5 poles ceiling power supply cable. Cable length 2000mm



- 10AA16**
- 10AA165P**









Ceiling installation kit.

- 10AA14LI**

FEATURES

-  Direct/Indirect emission
-  UGR <16; <22
-  IP 40

LED

-  3000K/4000K
-  >132 lm/W
-  CRI >90
-  Eye safety: R60/R61
-  Mac Adams 3
-  L80/B10 >50.000h

CERTIFICATIONS

-  EEA Conformity
-  Energy efficiency
-  5 years warranty

ON REQUEST

-  DALI - code D
-  Bluetooth - code BT*
-  Emergency 1 hr - code EM
Emergency 3 hrs - code EM3R*
-  2700K - code K27*

SPECIFICATIONS

Built-in driver.
 PG: Satin methacrylate diffuser for homogeneous emission UGR <22.
 HC: Diffuser with UGR <16 microcells.
 PG-HC: A combination of homogeneous emission and High Contrast.

BODY

Aluminum with epoxy powder coating.

COLORS

White RAL 9003 wrinkled
 - code W
 Black RAL 9005 wrinkled
 - code BK



PIPE LINE

PIPE LINE is a **suspended or ceiling-mounted technical and decorative** element for single installation. The innovative power supply system allows **electrical contact without the presence of cables through special rotors**. The tubes can be rotated to partialise the emission and slided to lengthen the product according to the application.

ID 86

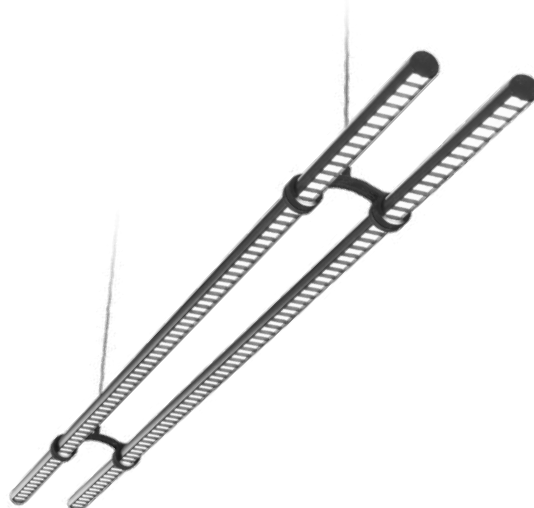

* Where available

PIPE LINE ^{PG}

IP 40

Methacrylate satin diffuser for soft diffusion,
UGR<22.

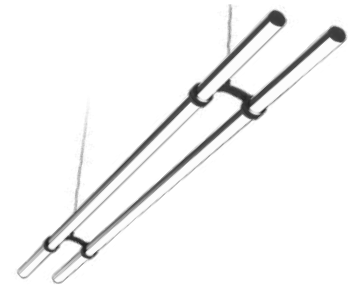
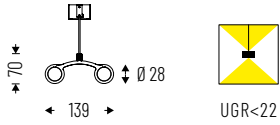

Cod. 4000K	Icon	lm	L mm
86PG48K4	48W	6354	1088
86PG62K4	62W	8184	1448

Cod. 3000K	Icon	lm	L mm
86PG48K3	48W	5845	1088
86PG62K3	62W	7529	1448

PIPE LINE ^{DK}

IP 40

Microcells High Contrast diffuser, UGR<16.

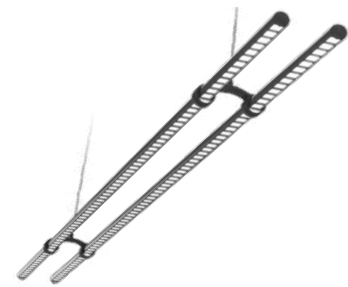
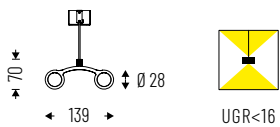

Cod. 4000K	Icon	lm	L mm
86DK48K4	48W	5538	1088
86DK62K4	62W	7149	1448

Cod. 3000K	Icon	lm	L mm
86DK48K3	48W	5150	1088
86DK62K3	62W	6648	1448

PIPE LINE PG-DK

IP 40

Combination between soft homogeneous emission and High Contrast microcells accents.

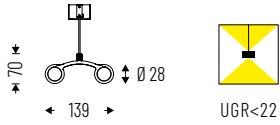

SUSPENDED/CEILING

Cod. 4000K	☼	lm	L mm
86DKD48K4	48W	5946	1088
86DKD62K4	62W	7667	1448

Cod. 3000K	☼	lm	L mm
86DKD48K3	48W	5497	1088
86DKD62K3	62W	7088	1448

TECHNICAL NOTES



SLIDING



ROTATING

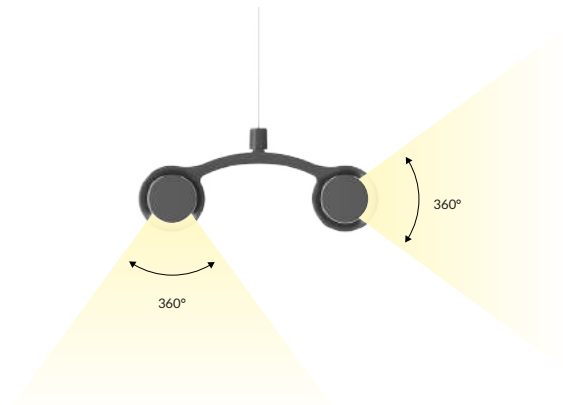

ELECTRICAL CONTACTS

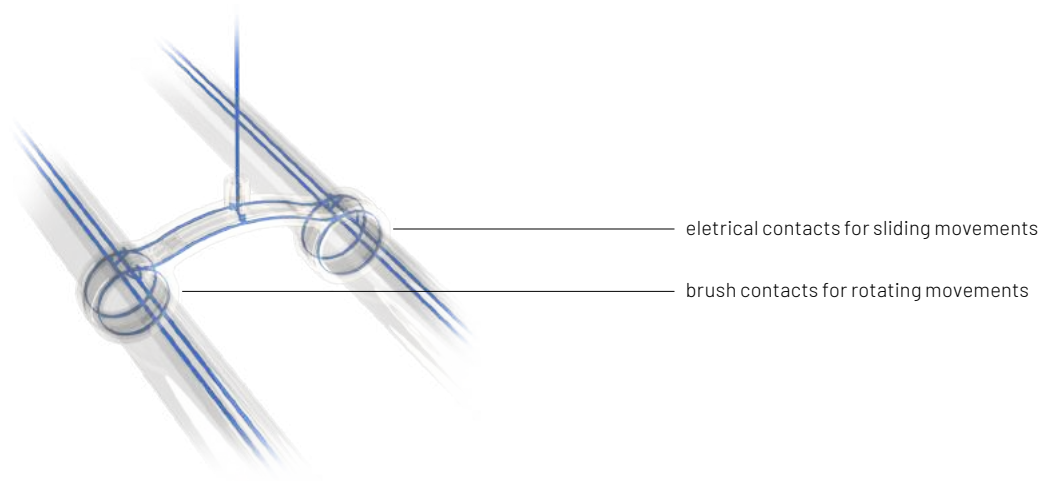





PIPELINE MONO

Elegant and extremely minimal design combined with high performance make **PIPE LINE MONO** a suspension with Direct emission suitable for illuminating any context: office, retail, or residential areas. The remote driver makes installation extremely flexible. The **PG optic with homogeneous emission** allows to illuminate environments with diffused light while the high contrast microcell optics with high glare control (UGR <16) is the perfect solution for desks and workstations.







ID 86



FEATURES

-  Direct emission
-  UGR <16; <22
-  IP 40





LED

-  3000K/4000K
-  >132 lm/W
-  CRI >90
-  Eye safety: RG0/RG1
-  Mac Adams 3
-  L80/B10 >50.000h

CERTIFICATIONS

-  EEA Conformity
-  Energy efficiency
-  5 years warranty

ON REQUEST

-  DALI - code D
-  Bluetooth - code BT*
-  Emergency 1 hr - code EM
Emergency 3 hrs - code EM3R*
-  2700K - code K27*

SPECIFICATIONS

Remote driver.
PG: Satin methacrylate diffuser for homogeneous emission UGR <22.
DK: Diffuser with UGR <16 microcells.

BODY

Aluminum with epoxy powder coating.

COLORS

White RAL 9003 wrinkled
- code W
Black RAL 9005 wrinkled
- code BK

* Where available

PIPE LINE MONO^{PG}

IP 40

Methacrylate satin diffuser for soft diffusion,
UGR<22.

Remote driver.

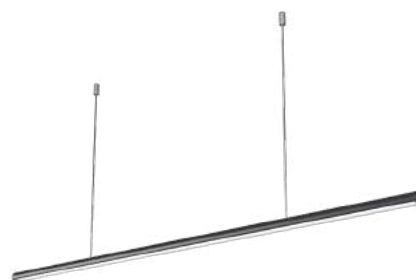
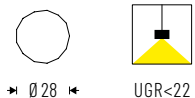

Cod. 4000K	☼	lm	L mm
86PG31K4M	31W	4092	1448
86PG39K4M	39W	5148	1808
86PG46K4M	46W	6072	2168
86PG54K4M	54W	7128	2528
86PG62K4M	62W	8184	2888

Cod. 3000K	☼	lm	L mm
86PG31K3M	31W	3765	1448
86PG39K3M	39W	4737	1808
86PG46K3M	46W	5587	2168
86PG54K3M	54W	6558	2528
86PG62K3M	62W	7530	2888

PIPE LINE MONO^{DK}

IP 40

High Contrast diffuser UGR<16.

Remote driver.



Cod. 4000K	☼	lm	L mm
86DK31K4M	31W	3575	1448
86DK39K4M	39W	4497	1808
86DK46K4M	46W	5305	2168
86DK54K4M	54W	6227	2528
86DK62K4M	62W	7150	2888

Cod. 3000K	☼	lm	L mm
86DK31K3M	31W	3324	1448
86DK39K3M	39W	4181	1808
86DK46K3M	46W	4931	2168
86DK54K3M	54W	5789	2528
86DK62K3M	62W	6646	2888



JOOLS

JOOLS is a suspension lamp with an **essential and compact shape but powerful in flow**, with bidirectional emission for **professional applications such as retail and hospitality**. With a highly decorative character, it is ideal for desks and reception areas as accent light, without sacrificing **indirect lighting for the whole environment**.

ID 11









Design
Serge & Robert Cornelissen

FEATURES

-  Direct/Indirect emission
-  UGR <19
-  IP 40

LED

-  3000K/4000K
-  >99 lm/W
-  CRI >90
-  Eye safety: R60/R61
-  Mac Adams 3
-  L80/B10 >50.000h

CERTIFICATIONS

-  EEA Conformity
-  Energy efficiency
-  5 years warranty

ON REQUEST

-  DALI - code D
-  2700K - code K27*
5000K - code K5*

SPECIFICATIONS

CoB LED technology.
Diffusing satin PC for indirect emission.
Direct emission with PC lens.
CUT-OFF > 30°

BODY

Aluminum with epoxy powder coating.

COLORS

White RAL 9003 - code W
Black RAL 9005 - code BK
Anodized champagne - code C67

RELATED PRODUCTS

Jools LV (P. 223)

* Where available

JOOOLS

IP 40

Indirect emission in diffusing satin PC. Direct emission with PC lens. CUT-OFF > 30°. Beam angles 14° - 35° - 55°.

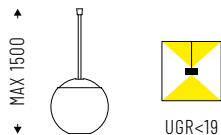

SUSPENDED/CEILING

Cod. 4000K	☼	lm	Ø mm
11DI19K414	19W 14°: 12W+7W	1881	150
11DI19K435	19W 35°: 12W+7W	1881	150
11DI19K455	19W 55°: 12W+7W	1881	150
11DI22K414	22W 14°: 14W+8W	2106	200
11DI22K435	22W 35°: 14W+8W	2106	200
11DI22K455	22W 55°: 14W+8W	2106	200
11DI27K414	27W 14°: 17W+10W	2498	250
11DI27K435	27W 35°: 17W+10W	2498	250
11DI27K455	27W 55°: 17W+10W	2498	250

Cod. 3000K	☼	lm	Ø mm
11DI19K314	19W 14°: 12W+7W	1768	150
11DI19K335	19W 35°: 12W+7W	1768	150
11DI19K355	19W 55°: 12W+7W	1768	150
11DI22K314	22W 14°: 14W+8W	1980	200
11DI22K335	22W 35°: 14W+8W	1980	200
11DI22K355	22W 55°: 14W+8W	1980	200
11DI27K314	27W 14°: 17W+10W	2349	250
11DI27K335	27W 35°: 17W+10W	2349	250
11DI27K355	27W 55°: 17W+10W	2349	250

Power/suspension cable included. Requires power supply box.

ACCESSORIES



Power supply box with built-in driver, for ceiling installation.

11AA16E



Power supply box with built-in driver, for ceiling installation. DALI version.

11AA16ED



Power supply box with built-in driver, for recessed installation.

11AA16ER



Power supply box with built-in driver, for recessed installation. DALI version.

11AA16ERD





STYLO

STYLO is a **miniaturized suspended element** with an elegant design that can be installed **individually** or three-phase tracks. Excellent glare control through a cut-off angle of over thirty degrees.







ID 88



FEATURES

-  Direct emission
-  UGR < 19
-  IP 40

LED

-  3000K/4000K
-  >72 lm/W
-  CRI > 90
-  Eye safety: R60/R61
-  Mac Adams 3
-  L80/B10 >50.000h

CERTIFICATIONS

-  EEA Conformity
-  Energy efficiency
-  5 years warranty

ON REQUEST

-  DALI - code D
-  2700K - code K27*
5000K - code K5*

SPECIFICATIONS

25° - 40° polycarbonate lens.
Honeycomb optic.
Diffusing decorative screen.

BODY

Aluminum with epoxy powder coating.

COLORS

White RAL 9003 wrinkled
- code W
Black RAL 9005 wrinkled
- code BK

RELATED PRODUCTS

Stylo LV (P. 225)

* Where available

STYLO

IP 40

Polycarbonate lens, 25° - 40° beam angle.
Complete with 1.5mt cable. Needs powered supply box.

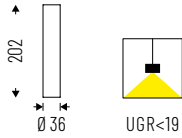

Cod. 4000K	Icon	lm	Ø mm
88PC5K425	5W 25°	360	36
88PC5K440	5W 40°	360	36
88PC8K425	8W 25°	574	36
88PC8K440	8W 40°	574	36

Cod. 3000K	Icon	lm	Ø mm
88PC5K325	5W 25°	318	36
88PC5K340	5W 40°	318	36
88PC8K325	8W 25°	508	36
88PC8K340	8W 40°	508	36

ACCESSORIES



Power supply box with built-in driver, for ceiling installation.

88AA16



Power supply box with built-in driver, for ceiling installation, DALI version.

88AA16D



Power supply box with built-in driver, for recessed installation.

88AA16R



Power supply box with built-in driver, for recessed installation, DALI version.

88AA16RD



Honeycomb optics.

88AAND



Diffusing decorative PG screen.

88AASD







WAVE

WAVE is the suspension element characterized by **soft lines**, which emphasizes the **sophisticated microcells High Contrast optical system** with high glare control.







ID 85



FEATURES

-  Direct emission
-  Direct/Indirect emission
-  UGR <16
-  IP 40



LED

-  3000K/4000K
-  >110 lm/W
-  CRI >90
-  Eye safety: RG0/RG1
-  Mac Adams 3
-  L80/B10 >50.000h

CERTIFICATIONS

-  EEA Conformity
-  Energy efficiency
-  5 years warranty

ON REQUEST

-  DALI - code D*
-  2700K - code K27*

SPECIFICATIONS

Built-in driver.
High Contrast UGR <16 diffuser.
Double emission: direct/indirect.

BODY

Aluminum with epoxy powder coating.

COLORS

White RAL 9003 - code B**
Black RAL 9005 - code C8

RELATED PRODUCTS

Wave Display (P. 71)

* Where available

** With black optics and end caps

WAVE

IP 40

High Contrast diffuser UGR<16.

End caps and suspensions included.

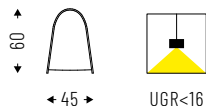

SUSPENDED/CEILING

Cod. 4000K	☼	lm	L mm
85DR26DKK4	26W	2938	1185
85DR36DKK4	36W	3852	1185
85DR31DKK4	31W	3503	1465
85DR45DKK4	45W	4815	1465
85DR37DKK4	37W	4181	1745
85DR54DKK4	54W	5778	1745
85DR61DKK4	61W	6893	2865
85DR90DKK4	90W	9630	2865

Cod. 3000K	☼	lm	L mm
85DR26DKK3	26W	2732	1185
85DR36DKK3	36W	3582	1185
85DR31DKK3	31W	3258	1465
85DR45DKK3	45W	4478	1465
85DR37DKK3	37W	3888	1745
85DR54DKK3	54W	5374	1745
85DR61DKK3	61W	6410	2865
85DR90DKK3	90W	8956	2865

WAVE DOUBLE EMISSION

IP 40

Direct / indirect emission with High Contrast diffuser UGR<16.

End caps and suspensions included.

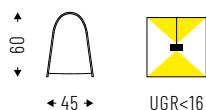

Cod. 4000K	☼	lm	L mm
85DI38DKK4	38W: 26W+12W	4234	1185
85DI48DKK4	48W: 36W+12W	5148	1185
85DI47DKK4	47W: 31W+16W	5231	1465
85DI61DKK4	61W: 45W+16W	6543	1465
85DI53DKK4	53W: 37W+16W	5909	1745
85DI70DKK4	70W: 54W+16W	7506	1745
85DI93DKK4	93W: 61W+32W	10349	2865
85DI122DKK4	122W: 90W+32W	13086	2865

Cod. 3000K	☼	lm	L mm
85DI38DKK3	38W: 26W+12W	3937	1185
85DI48DKK3	48W: 36W+12W	4787	1185
85DI47DKK3	47W: 31W+16W	4865	1465
85DI61DKK3	61W: 45W+16W	6085	1465
85DI53DKK3	53W: 37W+16W	5495	1745
85DI70DKK3	70W: 54W+16W	6981	1745
85DI93DKK3	93W: 61W+32W	9624	2865
85DI122DKK3	122W: 90W+32W	12170	2865

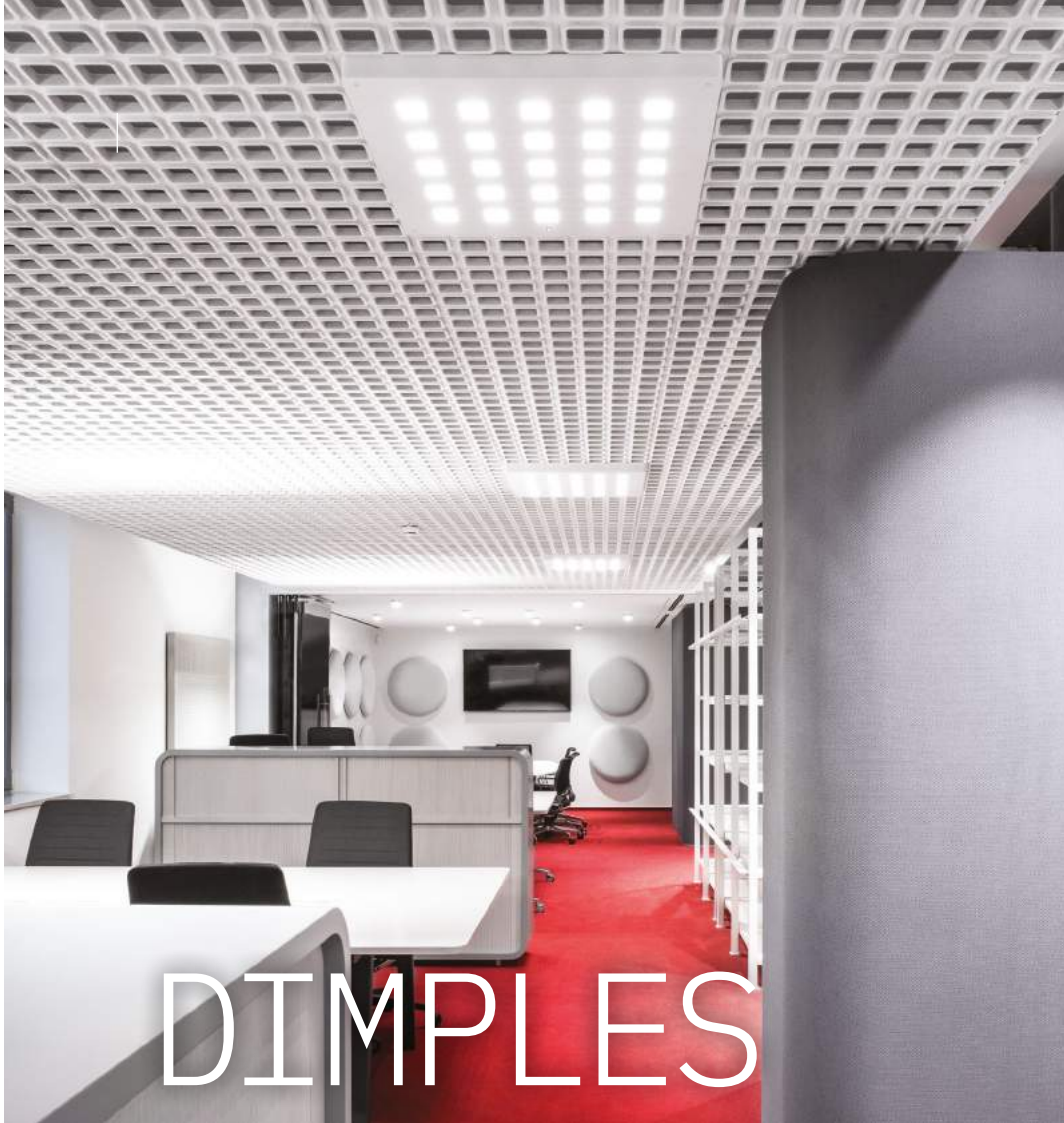





DIMPLES

DIMPLES is a recessed, suspended or ceiling mounted installation fixture, characterized by its very shallow profile height of just 38mm, with integrated drivers and unique aesthetics. The **individual microcells** contain optics that can either be specified for office applications **requiring low glare**, or for general lighting applications with broad lateral light distribution for core areas, including meeting rooms and breakout spaces. **DIMPLES** is offered in a wide range of outputs and sizes, for direct only or bidirectional light distribution, making it **extremely versatile** and a huge step beyond the conventional LED lit lighting panels.







ID 48



FEATURES

-  Direct emission
-  Direct/Indirect emission
-  UGR <16; <22
-  IP 40



LED

-  3000K/4000K
-  >100 lm/W
-  CRI >90
-  Eye safety: R60/R61
-  Mac Adams 3
-  L80/B10 >50.000h

CERTIFICATIONS

-  EEA Conformity
-  Energy efficiency
-  5 years warranty

ON REQUEST

-  DALI - code D*
-  Bluetooth - code BT*
-  Emergency 1 hr - code EM*
Emergency 3 hrs - code EM3R*

SPECIFICATIONS

Built-in driver.
Primary diffuser in satin PC UGR <16.
PG version with additional coplanar screen in opal PC UGR <22.
Double emission: direct / indirect.

BODY

Satin ABS with anodized aluminum base.

COLORS

White RAL 9003 - code B

RELATED PRODUCTS

Dimples recessed (P. 119)

* Where available

DIMPLES ^{MINI}

Accessories on page 108.

IP 40

Satin ABS reflectors with primary PC frosted diffuser, UGR<16.



Cod. 4000K		lm	L mm
48DR10K4	10W	1144	152
48DR13K4	13W	1487	152

Cod. 3000K		lm	L mm
48DR10K3	10W	1041	152
48DR13K3	13W	1353	152

DIMPLES ^{MINI} PG

Accessories on page 108.

IP 40

Satin ABS reflectors with primary PC frosted diffuser with additional frosted PC coplanar screen, UGR<22.



Cod. 4000K		lm	L mm
48PG10K4	10W	1087	152
48PG13K4	13W	1412	152

Cod. 3000K		lm	L mm
48PG10K3	10W	1087	152
48PG13K3	13W	1412	152

DIMPLES

Accessories on page 108.

IP 40

Satin ABS reflectors with primary PC frosted diffuser, UGR<16.

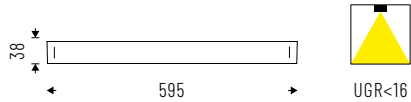

Cod. 4000K	Icon	lm	L mm
48DR44K4		44W	5132
			595

Cod. 3000K	Icon	lm	L mm
48DR44K3		44W	4618
			595

DIMPLES DOUBLE EMISSION

Accessories on page 108.

IP 40

Satin ABS reflectors with primary PC frosted diffuser, UGR<16, and upper diffuser for double emission: direct / indirect.

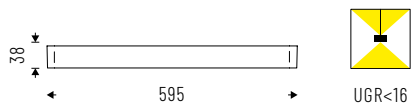

Cod. 4000K	Icon	lm	L mm
48DI60K4		60W: 44W+16W	6864
			595

Cod. 3000K	Icon	lm	L mm
48DI60K3		60W: 44W+16W	6246
			595

DIMPLES^{PG}

Accessories on page 108. **IP 40**

Satin ABS reflectors with primary PC frosted diffuser with additional frosted PC coplanar screen, UGR<22.

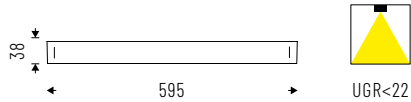

Cod. 4000K	Icon	lm	L mm
48PG44K4		44W	4874
			595

Cod. 3000K	Icon	lm	L mm
48PG44K3		44W	4435
			595

DIMPLES^{PG DOUBLE EMISSION}

Accessories on page 108. **IP 40**

Satin ABS reflectors with primary PC frosted diffuser, UGR<22, and upper diffuser for double emission: direct / indirect.

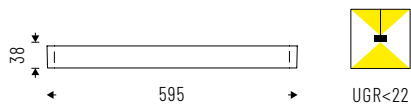

Cod. 4000K	Icon	lm	L mm
48DI60PGK4		60W: 44W+16W	6521
			595

Cod. 3000K	Icon	lm	L mm
48DI60PGK3		60W: 44W+16W	5933
			595

DIMPLES LONG

Accessories on page 108.

IP 40

Satin ABS reflectors with primary PC frosted diffuser, UGR<16.

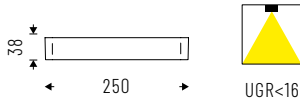

Cod. 4000K		Im	L mm
48DR35K4L	35W	4004	1195
48DR52K4L	52W	5949	1745

Cod. 3000K		Im	L mm
48DR35K3L	35W	3643	1195
48DR52K3L	52W	5413	1745

DIMPLES LONG DOUBLE EMISSION

Accessories on page 108.

IP 40

Satin ABS reflectors with primary PC frosted diffuser, UGR<16, and upper diffuser for double emission: direct / indirect.

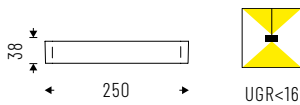

Cod. 4000K		Im	L mm
48DI52K4L	52W: 35W+17W	5949	1195
48DI70K4L	70W: 52W+18W	8008	1745

Cod. 3000K		Im	L mm
48DI52K3L	52W: 35W+17W	5413	1195
48DI70K3L	70W: 52W+18W	7288	1745

DIMPLES LONG PG

Accessories on page 108.

IP 40

Satin ABS reflectors with primary PC frosted diffuser with additional frosted PC coplanar screen, UGR<22.

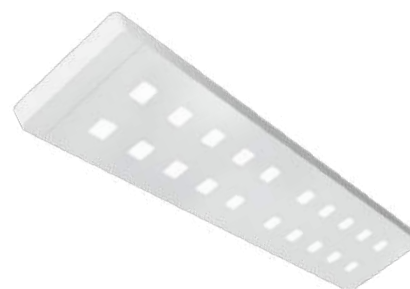
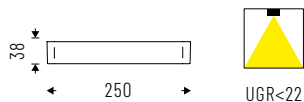

Cod. 4000K		Im	L mm
48PG35K4L	35W	3804	1195
48PG52K4L	52W	5652	1745

Cod. 3000K		Im	L mm
48PG35K3L	35W	3461	1195
48PG52K3L	52W	5143	1745

DIMPLES LONG PG DOUBLE EMISSION

Accessories on page 108.

IP 40

Satin ABS reflectors with primary PC frosted diffuser with additional frosted PC coplanar screen, UGR<22 and upper diffuser for double emission: direct / indirect.

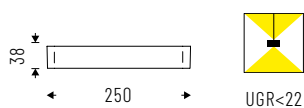

Cod. 4000K		Im	L mm
48DI52PGK4L	52W: 35W+17W	5652	1195
48DI70PGK4L	70W: 52W+18W	7608	1745

Cod. 3000K		Im	L mm
48DI52PGK3L	52W: 35W+17W	5143	1195
48DI70PGK3L	70W: 52W+18W	6923	1745

ACCESSORIES



Adjustable suspension kit.
Cable length 1500mm /
3000mm.

48AA13
48AA1330



3 - 5 poles ceiling
power supply cable.
Cable length 2000mm.

00AA16
00AA165P

TECHNICAL NOTES



OPTICS



PC version with body-diffuser in satin ABS and
CUT-OFF effect diffuser for glare control.





PG version with additional frosted PC coplanar screen.

CONNECTION









The installation of devices is immediate thanks
to the practical connector located in the back.

FEATURES

-  Direct emission
-  UGR <19; <22
-  IP 40



LED

-  3000K/4000K
-  >105 lm/W
-  CRI >90
-  Eye safety: R60/R61
-  Mac Adams 3
-  L80/B10 >50.000h

CERTIFICATIONS

-  EEA Conformity
-  Energy efficiency
-  5 years warranty

ON REQUEST

-  DALI - code D
-  Bluetooth - code BT*
-  Emergency 1 hr - code EM
Emergency 3 hrs - code EM3R*
-  5000K - code K5*

SPECIFICATIONS

Built-in driver.
MP technology for controlled UGR, with UGR <19.
PG diffuser for homogeneous emission, with UGR <22.

BODY

Aluminum with epoxy powder coating.

RELATED PRODUCTS

Lite recessed (P. 116)



LITE is a luminaire with a **minimal design and a compact section**, for ceiling and suspended mount. The power supply electronics are integrated into the body, while the closed optical system is protected against dust and accidental damage during installation. **The high efficiency LED modules** ensure **unmatched homogeneity** without precluding any light output. The **quick connection system** facilitates and speeds up the installation process.

ID 47



* Where available

LITE MP CEILING

Accessories on page 112.

IP 40

Microprismatic diffuser with UGR <19 for environments with display screen equipment.

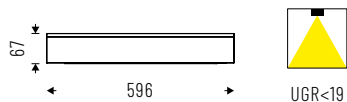

Cod. 4000K	☼	lm	L mm
47MP52K4	52W	5304	596
47MP64K4	64W	6528	596

Cod. 3000K	☼	lm	L mm
47MP52K3	52W	4985	596
47MP64K3	64W	6135	596

LITE PG CEILING

Accessories on page 112.

IP 40

Methacrylate plate painted with opaline antistatic treatment for soft diffusing light emission, UGR<22.

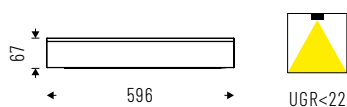

Cod. 4000K	☼	lm	L mm
47PG52K4	52W	5460	596
47PG64K4	64W	6720	596

Cod. 3000K	☼	lm	L mm
47PG52K3	52W	5132	596
47PG64K3	64W	6316	596

LITE MP LONG CEILING

Accessories on page 112.

IP 40

Microprismatic diffuser with UGR <19 for environments with display screen equipment.

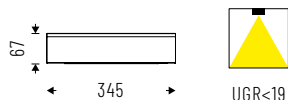

Cod. 4000K	☼	lm	L mm
47MP26K4M3	26W	2652	596
47MP33K4M3	33W	3366	596
47MP52K4M3	52W	5304	1100
47MP64K4M3	64W	6528	1100
47MP78K4M3	78W	7956	1604
47MP99K4M3	99W	10098	1604

Cod. 3000K	☼	lm	L mm
47MP26K3M3	26W	2492	596
47MP33K3M3	33W	3163	596
47MP52K3M3	52W	4985	1100
47MP64K3M3	64W	6135	1100
47MP78K3M3	78W	7477	1604
47MP99K3M3	99W	9488	1604

LITE PG LONG CEILING

Accessories on page 112.

IP 40

Methacrylate plate painted with opaline antistatic treatment for soft diffusing light emission, UGR <22.

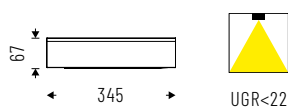

Cod. 4000K	☼	lm	L mm
47PG26K4M3	26W	2730	596
47PG33K4M3	33W	3465	596
47PG52K4M3	52W	5460	1100
47PG64K4M3	64W	6720	1100
47PG78K4M3	78W	8190	1604
47PG99K4M3	99W	10395	1604

Cod. 3000K	☼	lm	L mm
47PG26K3M3	26W	2566	596
47PG33K3M3	33W	3256	596
47PG52K3M3	52W	5132	1100
47PG64K3M3	64W	6316	1100
47PG78K3M3	78W	7698	1604
47PG99K3M3	99W	9769	1604

ACCESSORIES



Adjustable suspension kit.
Cable length 1500mm /
3000mm.

47AA13
47AA1330



3 - 5 poles ceiling
power supply box.
Cable length 2000mm.

00AA16
00AA165P



RECESSED

RECESSED

Absent Essential **114**

ID41



Lite **116**

ID47



Dimples **119**

ID48



Flip **121**

ID42



Ben **124**

ID10



C
H
A
P
T
E
R

T
H
R
E
E

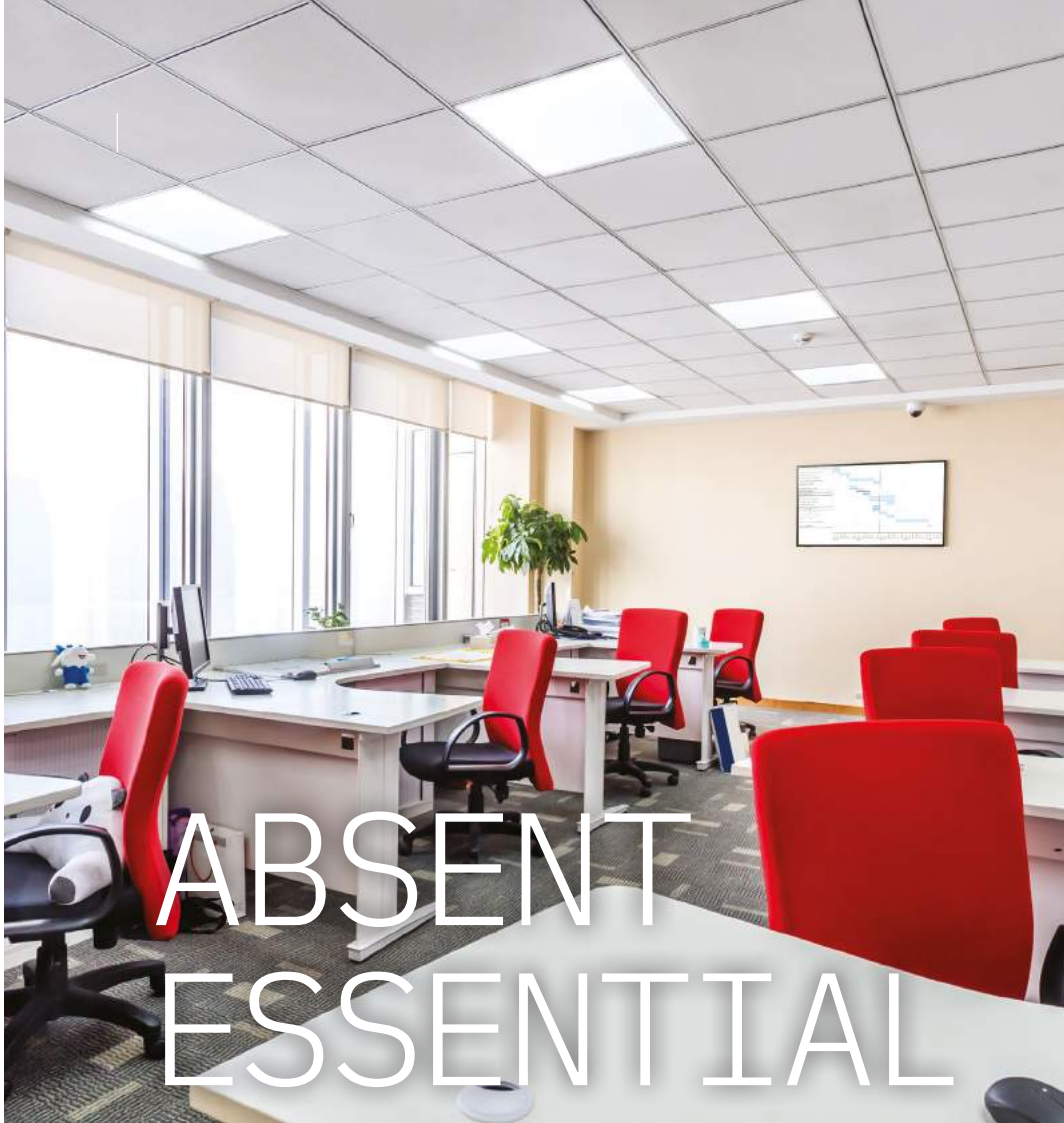



ABSENT ESSENTIAL

ABSENT ESSENTIAL represents a **high-quality, essential and efficient back-lighting solution** for offices or public spaces. Suitable for recessed, ceiling or suspended installation, **ABSENT ESSENTIAL** comes in different dimensions that make it **versatile in every context**.







ID 41



FEATURES

-  Direct emission
-  UGR <19
-  IP 40





LED

-  3000K/4000K
-  >115 lm/W
-  CRI >94
-  Eye safety: R60
-  Mac Adams 3
-  L80/B10 >50.000h

CERTIFICATIONS

-  EEA Conformity
-  Energy efficiency
-  5 years warranty

ON REQUEST

-  DALI - code D
-  Bluetooth - code BT*
-  Emergency 1 hr - code EM
-  Emergency 3 hrs - code EM3R*
-  False ceiling version 625x625mm*

SPECIFICATIONS

DPL technology for controlled emission UGR <19.

BODY

Aluminum with epoxy powder coating.

* Where available

ABSENT ESSENTIAL ^{DPL}

IP 40

Diffuser with Diamond Prism LED (DPL) technology for controlled emission UGR <19.

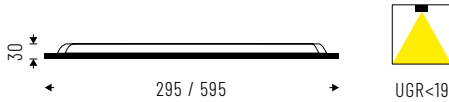

Cod. 4000K	W	lm	L mm
41DPL18K4E	18W	1750	295x295
41DPL36K4E	36W	4140	595x595
41DPL22K4EM3	22W	2150	595x295
41DPL36K4EM3	36W	4140	1195x295
41DPL60K4EM6	60W	7150	1195x595

Cod. 3000K	W	lm	L mm
41DPL18K3E	18W	1610	295x295
41DPL36K3E	36W	3809	595x595
41DPL22K3EM3	22W	1978	595x295
41DPL36K3EM3	36W	3809	1195x295
41DPL60K3EM6	60W	6578	1195x595

ACCESSORIES



Plasterboard installation kit.

41AA17E



Adjustable suspension kit. Cable length 3000mm.

41AA1330E



Ceiling installation kit.

41AAE300300
41AAE600600
41AAE600300
41AAE1200300
41AAE1200600



3 - 5 poles ceiling power supply box. Cable length 2000mm.

00AA16
00AA165P

TECHNICAL NOTES

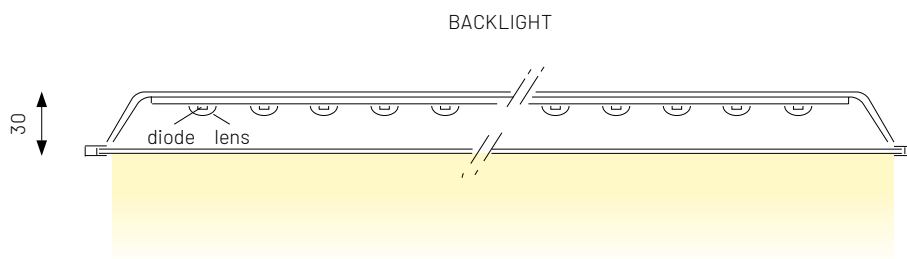

UNIFORM EMISSION UGR<19





LITE

LITE is the recessed installation luminaire characterized by its **minimal design and compact section**. The power supply electronics are integrated inside the body, while the closed **optical system is protected against dust and accidental damage** during installation. The **high-efficiency LED modules** ensure an elevated homogeneity without precluding light output.

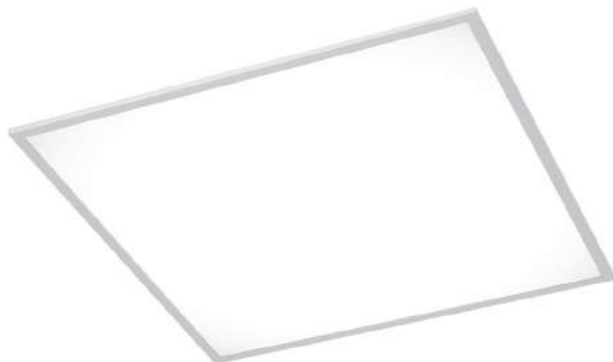





ID 47



FEATURES

-  Direct emission
-  UGR <19; <22
-  IP 40





LED

-  3000K/4000K
-  >105 lm/W
-  CRI >90
-  Eye safety: R60/R61
-  Mac Adams 3
-  L80/B10 >50.000h

CERTIFICATIONS

-  EEA Conformity
-  Energy efficiency
-  5 years warranty

ON REQUEST

-  DALI - code D
-  Bluetooth - code BT*
-  Emergency 1 hr - code EM
Emergency 3 hrs - code EM3R*
-  5000K - code K5*
-  False ceiling version
625x625mm*

SPECIFICATIONS

Built-in driver.
MP technology for controlled UGR, with UGR <19.
PG diffuser for homogeneous emission, with UGR <22.

BODY

Aluminum with epoxy powder coating.

RELATED PRODUCTS

Lite suspended/ceiling (P. 109)

* Where available

LITE MP RECESSED

IP 40

Microprismatic diffuser with UGR <19 for environments with display screen equipment.

For recessed installation on false ceiling with visible structure.

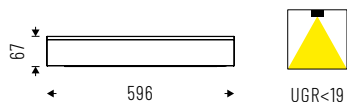

Cod. 4000K	Icon	lm	L mm
47MP52K4R	52W	5304	596
47MP64K4R	64W	6528	596

Cod. 3000K	Icon	lm	L mm
47MP52K3R	52W	4925	596
47MP64K3R	64W	6135	596

LITE PG RECESSED

IP 40

Methacrylate plate painted with opaline antistatic treatment for soft diffusing light emission, UGR<22.

For recessed installation on false ceiling with visible structure.

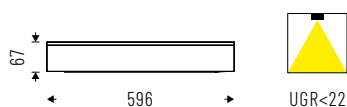

Cod. 4000K	Icon	lm	L mm
47PG52K4R	52W	5460	596
47PG64K4R	64W	6720	596

Cod. 3000K	Icon	lm	L mm
47PG52K3R	52W	5132	596
47PG64K3R	64W	6316	596

LITE MP LONG RECESSED

IP 40

Microprismatic diffuser with UGR <19 for environments with display screen equipment.

For recessed installation on false ceiling with visible structure.



Cod. 4000K	☼	lm	L mm
47MP52K4M3V	52W	5304	1196
47MP64K4M3V	64W	6528	1196

Cod. 3000K	☼	lm	L mm
47MP52K3M3V	52W	4925	1196
47MP64K3M3V	64W	6135	1196

LITE PG LONG RECESSED

IP 40

Methacrylate plate painted with opaline antistatic treatment for soft diffusing light emission, UGR<22.

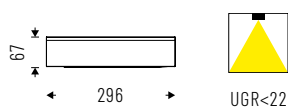

For recessed installation on false ceiling with visible structure..









Cod. 4000K	☼	lm	L mm
47PG52K4M3V	52W	5460	1196
47PG64K4M3V	64W	6720	1196

Cod. 3000K	☼	lm	L mm
47PG52K3M3V	52W	5132	1196
47PG64K3M3V	64W	6316	1196

FEATURES

-  Direct emission
-  UGR <16; <22
-  IP 40



LED

-  3000K/4000K
-  >97 lm/W
-  CRI >100
-  Eye safety: R60/R61
-  Mac Adams 3
-  L80/B10 >50.000h

CERTIFICATIONS

-  EEA Conformity
-  Energy efficiency
-  5 years warranty

ON REQUEST

-  DALI - code D
-  Bluetooth - code BT*
-  Emergency 1 hr - code EM
Emergency 3 hrs - code EM3R*

SPECIFICATIONS

Built-in driver.
Primary diffuser in satin PC UGR <16.
PG version with additional coplanar screen in opal PC UGR <22.
Double emission: direct / indirect.

BODY

Satin ABS with anodized aluminum base.

COLORS

White RAL 9003 - code B

RELATED PRODUCTS

Dimples suspended/ceiling (P. 102)



DIMPLES

DIMPLES is a recessed, suspended and ceiling mounted installations fixture, characterized by a very shallow profile height of just 38mm, with integrated drivers and unique aesthetics. The **individual microcells** contain optics that can either be specified for offices applications requiring **low glare**, or for general lighting applications with **broad lateral light distribution** for core areas, including meeting rooms and break-out spaces. **DIMPLES** is offered in a wide range of outputs and sizes, for **direct only or bidirectional light** distribution, making it an **extremely versatile** lighting collection and a huge step beyond the conventional LED lit lighting panels.

ID 48



* Where available

DIMPLES

IP 40

Satin ABS reflectors with primary PC frosted diffuser, UGR<16.

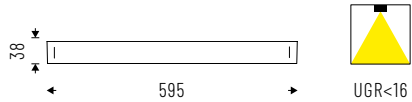

Cod. 4000K		lm	L mm
48DR44K4	44W	5132	595

Cod. 3000K		lm	L mm
48DR44K3	44W	4618	595

DIMPLES^{PG}

IP 40

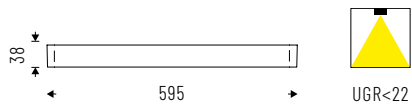

Satin ABS reflectors with primary PC frosted diffuser and additional frosted PC coplanar screen, UGR<22.









Cod. 4000K		lm	L mm
48PG44K4	44W	4874	595

Cod. 3000K		lm	L mm
48PG44K3	44W	4435	595

FEATURES

-  Direct emission
-  UGR <16; <22
-  IP 40

LED

-  3000K/4000K
-  >125 lm/W
-  CRI >90
-  Eye safety: R60/R61
-  Mac Adams 3
-  L80/B10 >50.000h

CERTIFICATIONS

-  EEA Conformity
-  Energy efficiency
-  5 years warranty

ON REQUEST

-  DALI - code D
-  Bluetooth - code BT*
-  Emergency 1 hr - code EM*
Emergency 3 hrs - code EM3R*

SPECIFICATIONS

Polycarbonate lens with ILC (Indirect Light Control) emission to favor indirect illumination, UGR <16. PG diffuser for homogeneous emission, with UGR <22.



FLIP

FLIP is the new and **revolutionary lighting method** for spaces with **24mm visible structure suspended ceilings**. The ultra-slim linear luminaire can be arranged as desired to create light patterns, allowing designers greater creative freedom in respect to standard panels. Controlled direct emission ensures a low glare index (UGR <16) making **FLIP** ideal for both office lighting and general spaces. The lateral emission ensures that the luminaire uses the false ceiling as a reflective surface, to maximize visual comfort, it is also available in PG version, for those environments where diffused lighting is needed. **FLIP: free your creativity.**

ID 42



* Where available

FLIP

IP 40

Polycarbonate lens with ILC (Indirect Light Control) emission to favor indirect lighting, UGR <16.

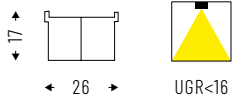

Cod. 4000K		lm	L mm
42PC9K4	9W	1026	599

Cod. 3000K		lm	L mm
42PC9K3	9W	995	599

FLIP^{PG}

IP 40

PG lens in frosted polycarbonate. UGR<22.

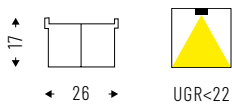

Cod. 4000K		lm	L mm
42P09K4	9W	1020	599

Cod. 3000K		lm	L mm
42P09K3	9W	989	599

ACCESSORIES



Straight electrified connector.

42AA1EL



2 ways 90° electrified connector.

42AA05EL



3 ways electrified connector.

42AA06EL



4 ways electrified connector.

42AA07EL



Driver 24V 35W for 1 fixture.

42LC1X



Driver 24V 35W for 1 fixture, DALI version.

42LC1XD



Driver 24V 60W up to 4 fixtures.

42LC4X



Driver 24V 60W up to 4 fixtures, DALI version.

42LC4XD



Driver 24V 100W up to 10 fixtures.

42LC10X



Driver 24V 100W up to 10 fixtures, DALI version.

42LC10XD



Kit for installation on plasterboard or semi-recessed panels.

42AA14

RECESSED

TECHNICAL NOTES



Thanks to the electrified connector and the side clips, installation to the false ceiling structure is immediate.



BEN

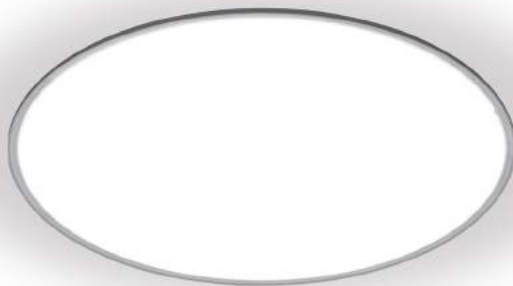

BEN is the universal luminaire for wall, ceiling, suspension or recessed installation with bodies **made entirely of aluminum**, without welding. The **IP40** version offers both satin and microprismatic diffusers with DPL UGR <19 technology. **The mid-power LED on circular boards avoid the creation of shadow areas** and are connected to the internal supports via quick connectors, for easy electrification.

ID 10









Design
Serge & Robert Cornelissen





FEATURES

-  Direct emission
-  UGR <19; <22
-  IP 40



LED

-  3000K/4000K
-  >124 lm/W
-  CRI >90
-  Eye safety: R60/R61
-  Mac Adams 3
-  L80/B10 >50.000h

CERTIFICATIONS

-  EEA Conformity
-  Energy efficiency
-  5 years warranty
-  ETL certification

ON REQUEST

-  DALI - code D
-  Bluetooth - code BT*
-  Emergency 1 hr - code EM*
Emergency 3 hrs - code EM3R*
-  2700K - code K27*
-  Human Centric Lighting*

SPECIFICATIONS

Built-in driver.
PG diffuser in satin-finish acrylic resistant to UGR <22 shocks.
Impact resistant DPL diffuser with homogeneous and controlled emission UGR <19 (accessory).

BODY

Aluminum with epoxy powder coating.

COLORS

Matte white RAL 9003 - code B

RELATED PRODUCTS

BEN suspended/ceiling (P. 84)
BEN wall (P. 249)
BEN IP54 (P. 315)

* Where available

BEN SMALL IP40 PG

Accessories on page 127.

IP 40

PG diffuser with frosted Acryl-Satiné and impact resistant diffuser UGR<22.

Recessed mount accessory not included.

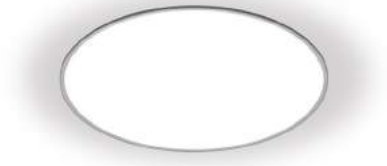
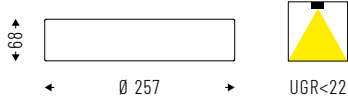

Cod. 4000K	Icon	lm	Ø mm
10PG6K4	6W	749	257
10PG12K4	12W	1497	257
10PG18K4	18W	2246	257

Cod. 3000K	Icon	lm	Ø mm
10PG6K3	6W	712	257
10PG12K3	12W	1422	257
10PG18K3	18W	2138	257

BEN MEDIUM IP40 PG

Accessories on page 127.

IP 40

PG diffuser with frosted Acryl-Satiné and impact resistant diffuser UGR<22.

Recessed mount accessory not included.

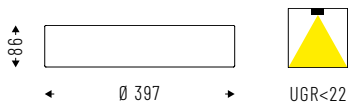

Cod. 4000K	Icon	lm	Ø mm
10PG16K4	16W	1994	397
10PG25K4	25W	3113	397

Cod. 3000K	Icon	lm	Ø mm
10PG16K3	16W	1894	397
10PG25K3	25W	2957	397

BEN LARGE IP40 PG

IP 40

PG diffuser with frosted Acryl-Satiné and impact resistant diffuser UGR<22.

Recessed mount accessory not included.

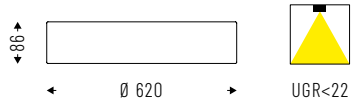

Cod. 4000K		lm	Ø mm
10PG60K4	60W	7476	620
10PG112K4	112W	13955	620

Cod. 3000K		lm	Ø mm
10PG60K3	60W	7102	620
10PG112K3	112W	13257	620

BEN XL IP40 PG

IP 40

PG diffuser with frosted Acryl-Satiné and impact resistant diffuser UGR<22.

Recessed mount accessory not included.

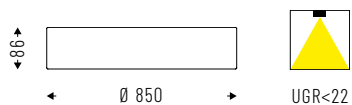

Cod. 4000K		lm	Ø mm
10PG70K4	70W	8722	850
10PG150K4	150W	18690	850

Cod. 3000K		lm	Ø mm
10PG70K3	70W	8286	850
10PG150K3	150W	17756	850

BEN MAXI IP40 PG

IP 40

PG diffuser with frosted Acryl-Satiné and impact resistant diffuser UGR<22.

Recessed mount accessory not included.

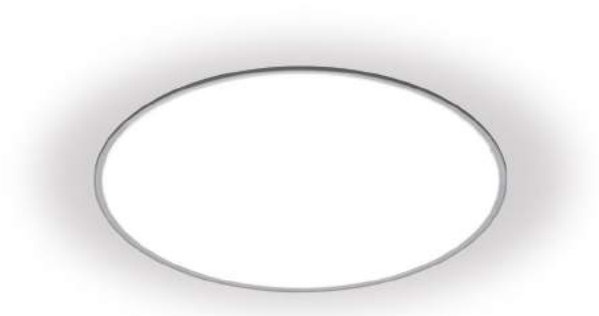
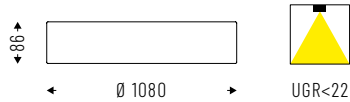

RECESSED

Cod. 4000K	Icon	lm	Ø mm
10PG180K4	180W	22428	1080
10PG240K4	240W	29904	1080

Cod. 3000K	Icon	lm	Ø mm
10PG180K3	180W	21307	1080
10PG240K3	240W	28409	1080

ACCESSORIES



DPL diffuser for IP40 versions.

- 10AADPLS** - BEN SMALL
- 10AADPLM** - BEN MEDIUM
- 10AADPLL** - BEN LARGE
- 10AADPLXL** - BEN XL
- 10AADPLMX** - BEN MAXI



Kit for recessed frameless installation on plasterboard and concrete.

- 10AA19SFL** - BEN SMALL
- 10AA19MFL** - BEN MEDIUM
- 10AA19LFL** - BEN LARGE



Kit for recessed installation on plasterboard and concrete.

- 10AA19S** - BEN SMALL
- 10AA19M** - BEN MEDIUM
- 10AA19L** - BEN LARGE















C
H
A
P
T
E
R

F
O
U
R

DOWNLIGHT

DOWNLIGHT

Make	130	ID39	
Make Q	138	ID39	
Make R	143	ID39	
Teres Micro Zoom Recessed	147	ID14	
Hall Led Deep	150	ID38	
Cube Mini	152	ID49	
Box Led	155	ID44	
Hall Led Pro	158	ID38	
Hall Led Essential	161	ID38	
Otello Led	163	ID45	
Next	166	ID50	
Hall Led Ceiling Evo	171	ID28	
Hall Led Essential Ceiling	175	ID28	





MAKE

MAKE is the new **adjustable downlight** developed in different configurations: with edge, frameless, with double spot or with backward optics. **MAKE** is available in five sizes: micro, mini, small, medium and large, for installation from 50 to 150 mm in diameter.







ID 39



FEATURES

-  Direct emission
-  UGR <16**; <19
-  IP 44





LED

-  3000K/4000K
-  >100 lm/W
-  CRI >90
-  Eye safety: RG0/RG1
-  Mac Adams 3
-  L80/B10 >50.000h

CERTIFICATIONS

-  EEA Conformity
-  Energy efficiency
-  5 years warranty

ON REQUEST

-  DALI - code D
-  Bluetooth - code BT*
-  Emergency 1 hr - code EM
Emergency 3 hrs - code EM3R*
-  2700K - code K27*
5000K - code K5*

SPECIFICATIONS

Built-in drivers.
Polycarbonate lens,
beam angles: 15°, 24°, 36°, 50°.
Front reflector in polycarbonate.

BODY

Aluminum with epoxy
powder coating.

COLORS

White RAL 9003 wrinkled
- code W
Black RAL 9005 wrinkled
- code BK

*Where available.

**With accessories 30A111GP

MAKE MICRO

Accessories on page 137.

IP 44

Adjustable recessed installation.
Polycarbonate lens Ø 25 mm.
Beam angles: 15° - 24° - 36° - 50°.

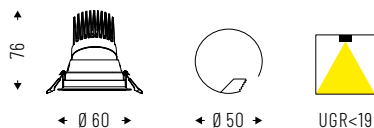

Cod. 4000K	☼	lm	Ø mm
390R3K415	3W 15°	375	60
390R3K424	3W 24°	375	60
390R3K436	3W 36°	375	60
390R3K450	3W 50°	375	60
390R6K415	6W 15°	600	60
390R6K424	6W 24°	600	60
390R6K436	6W 36°	600	60
390R6K450	6W 50°	600	60
390R9K415	9W 15°	793	60
390R9K424	9W 24°	793	60
390R9K436	9W 36°	793	60
390R9K450	9W 50°	793	60

Cod. 3000K	☼	lm	Ø mm
390R3K315	3W 15°	355	60
390R3K324	3W 24°	355	60
390R3K336	3W 36°	355	60
390R3K350	3W 50°	355	60
390R6K315	6W 15°	568	60
390R6K324	6W 24°	568	60
390R6K336	6W 36°	568	60
390R6K350	6W 50°	568	60
390R9K315	9W 15°	752	60
390R9K324	9W 24°	752	60
390R9K336	9W 36°	752	60
390R9K350	9W 50°	752	60

DOWNLIGHT

MAKE MINI

Accessories on page 137.

IP 44

Adjustable recessed installation.
Polycarbonate lens Ø 35 mm.
Beam angles: 15° - 24° - 36° - 50°.

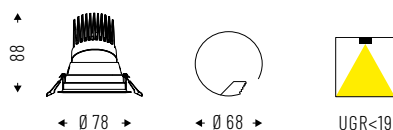

Cod. 4000K	☼	lm	Ø mm
390R3K415MN	3W 15°	353	78
390R3K424MN	3W 24°	353	78
390R3K436MN	3W 36°	353	78
390R3K450MN	3W 50°	353	78
390R6K415MN	6W 15°	600	78
390R6K424MN	6W 24°	600	78
390R6K436MN	6W 36°	600	78
390R6K450MN	6W 50°	600	78
390R11K415MN	11W 15°	897	78
390R11K424MN	11W 24°	897	78
390R11K436MN	11W 36°	897	78
390R11K450MN	11W 50°	897	78

Cod. 3000K	☼	lm	Ø mm
390R3K315MN	3W 15°	348	78
390R3K324MN	3W 24°	348	78
390R3K336MN	3W 36°	348	78
390R3K350MN	3W 50°	348	78
390R6K315MN	6W 15°	591	78
390R6K324MN	6W 24°	591	78
390R6K336MN	6W 36°	591	78
390R6K350MN	6W 50°	591	78
390R11K315MN	11W 15°	852	78
390R11K324MN	11W 24°	852	78
390R11K336MN	11W 36°	852	78
390R11K350MN	11W 50°	852	78

MAKE SMALL

Accessories on page 137.

IP 44

Adjustable recessed installation.
Polycarbonate lens Ø 50 mm.
Beam angles: 15° - 24° - 36° - 50°.

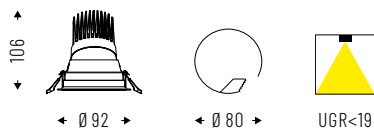

Cod.	4000K	☼	lm	Ø mm
390R9K415S	9W	15°	935	92
390R9K424S	9W	24°	935	92
390R9K436S	9W	36°	935	92
390R9K450S	9W	50°	935	92
390R13K415S	13W	15°	1285	92
390R13K424S	13W	24°	1285	92
390R13K436S	13W	36°	1285	92
390R13K450S	13W	50°	1285	92
390R18K415S	18W	15°	1825	92
390R18K424S	18W	24°	1825	92
390R18K436S	18W	36°	1825	92
390R18K450S	18W	50°	1825	92

Cod.	3000K	☼	lm	Ø mm
390R9K315S	9W	15°	919	92
390R9K324S	9W	24°	919	92
390R9K336S	9W	36°	919	92
390R9K350S	9W	50°	919	92
390R13K315S	13W	15°	1263	92
390R13K324S	13W	24°	1263	92
390R13K336S	13W	36°	1263	92
390R13K350S	13W	50°	1263	92
390R18K315S	18W	15°	1795	92
390R18K324S	18W	24°	1795	92
390R18K336S	18W	36°	1795	92
390R18K350S	18W	50°	1795	92

MAKE MEDIUM

Accessories on page 137.

IP 44

Adjustable recessed installation.
Polycarbonate lens Ø 75 mm.
Beam angles: 15° - 24° - 36° - 50°.

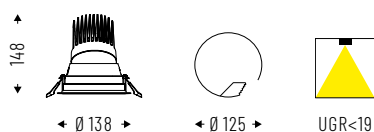

Cod.	4000K	☼	lm	Ø mm
390R18K415M	18W	15°	1944	138
390R18K424M	18W	24°	1944	138
390R18K436M	18W	36°	1944	138
390R18K450M	18W	50°	1944	138
390R27K415M	27W	15°	2610	138
390R27K424M	27W	24°	2610	138
390R27K436M	27W	36°	2610	138
390R27K450M	27W	50°	2610	138
390R36K415M	36W	15°	3497	138
390R36K424M	36W	24°	3497	138
390R36K436M	36W	36°	3497	138
390R36K450M	36W	50°	3497	138

Cod.	3000K	☼	lm	Ø mm
390R18K315M	18W	15°	1914	138
390R18K324M	18W	24°	1914	138
390R18K336M	18W	36°	1914	138
390R18K350M	18W	50°	1914	138
390R27K315M	27W	15°	2570	138
390R27K324M	27W	24°	2570	138
390R27K336M	27W	36°	2570	138
390R27K350M	27W	50°	2570	138
390R36K315M	36W	15°	3448	138
390R36K324M	36W	24°	3448	138
390R36K336M	36W	36°	3448	138
390R36K350M	36W	50°	3448	138

MAKE LARGE

Accessories on page 137.

IP 44

Adjustable recessed installation.
Polycarbonate lens Ø 83 mm.
Beam angles: 15° - 24° - 36° - 50°.

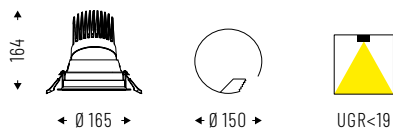

Cod. 4000K	W	Beam angle	lm	Ø mm
39OR25K415L	25W	15°	2553	165
39OR25K424L	25W	24°	2553	165
39OR25K436L	25W	36°	2553	165
39OR25K450L	25W	50°	2553	165
39OR36K415L	36W	15°	3503	165
39OR36K424L	36W	24°	3503	165
39OR36K436L	36W	36°	3503	165
39OR36K450L	36W	50°	3503	165
39OR40K415L	40W	15°	4401	165
39OR40K424L	40W	24°	4401	165
39OR40K436L	40W	36°	4401	165
39OR40K450L	40W	50°	4401	165

Cod. 3000K	W	Beam angle	lm	Ø mm
39OR25K315L	25W	15°	2515	165
39OR25K324L	25W	24°	2515	165
39OR25K336L	25W	36°	2515	165
39OR25K350L	25W	50°	2515	165
39OR36K315L	36W	15°	3402	165
39OR36K324L	36W	24°	3402	165
39OR36K336L	36W	36°	3402	165
39OR36K350L	36W	50°	3402	165
39OR40K315L	40W	15°	4353	165
39OR40K324L	40W	24°	4353	165
39OR40K336L	40W	36°	4353	165
39OR40K350L	40W	50°	4353	165

DOWNLIGHT

MAKE FL MINI

Accessories on page 137.

IP 44

Adjustable recessed installation.
Polycarbonate lens Ø 35 mm.
Beam angles: 15° - 24° - 36° - 50°.

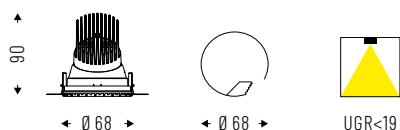

Cod. 4000K	W	Beam angle	lm	Ø mm
39FL3K415MN	3W	15°	353	68
39FL3K424MN	3W	24°	353	68
39FL3K436MN	3W	36°	353	68
39FL3K450MN	3W	50°	353	68
39FL6K415MN	6W	15°	600	68
39FL6K424MN	6W	24°	600	68
39FL6K436MN	6W	36°	600	68
39FL6K450MN	6W	50°	600	68
39FL11K415MN	11W	15°	897	68
39FL11K424MN	11W	24°	897	68
39FL11K436MN	11W	36°	897	68
39FL11K450MN	11W	50°	897	68

Cod. 3000K	W	Beam angle	lm	Ø mm
39FL3K315MN	3W	15°	348	68
39FL3K324MN	3W	24°	348	68
39FL3K336MN	3W	36°	348	68
39FL3K350MN	3W	50°	348	68
39FL6K315MN	6W	15°	591	68
39FL6K324MN	6W	24°	591	68
39FL6K336MN	6W	36°	591	68
39FL6K350MN	6W	50°	591	68
39FL11K315MN	11W	15°	852	68
39FL11K324MN	11W	24°	852	68
39FL11K336MN	11W	36°	852	68
39FL11K350MN	11W	50°	852	68

MAKE FL SMALL

Accessories on page 137.

IP 44

Recessed frameless installation with adjustable light source. Polycarbonate lens Ø 50 mm.
Beam angles: 15° - 24° - 36° - 50°.

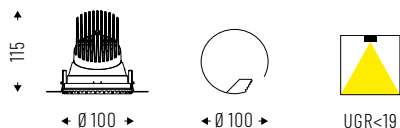

Cod.	4000K	Beam Angle	lm	Ø mm
39FL9K415S	9W	15°	935	100
39FL9K424S	9W	24°	935	100
39FL9K436S	9W	36°	935	100
39FL9K450S	9W	50°	935	100
39FL13K415S	13W	15°	1285	100
39FL13K424S	13W	24°	1285	100
39FL13K436S	13W	36°	1285	100
39FL13K450S	13W	50°	1285	100
39FL18K415S	18W	15°	1825	100
39FL18K424S	18W	24°	1825	100
39FL18K436S	18W	36°	1825	100
39FL18K450S	18W	50°	1825	100

Cod.	3000K	Beam Angle	lm	Ø mm
39FL9K315S	9W	15°	919	100
39FL9K324S	9W	24°	919	100
39FL9K336S	9W	36°	919	100
39FL9K350S	9W	50°	919	100
39FL13K315S	13W	15°	1263	100
39FL13K324S	13W	24°	1263	100
39FL13K336S	13W	36°	1263	100
39FL13K350S	13W	50°	1263	100
39FL18K315S	18W	15°	1795	100
39FL18K324S	18W	24°	1795	100
39FL18K336S	18W	36°	1795	100
39FL18K350S	18W	50°	1795	100

MAKE FL MEDIUM

Accessories on page 137.

IP 44

Recessed frameless installation with adjustable light source. Polycarbonate lens Ø 75 mm.
Beam angles: 15° - 24° - 36° - 50°.

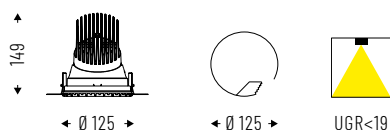

Cod.	4000K	Beam Angle	lm	Ø mm
39FL18K415M	18W	15°	1944	125
39FL18K424M	18W	24°	1944	125
39FL18K436M	18W	36°	1944	125
39FL18K450M	18W	50°	1944	125
39FL27K415M	27W	15°	2610	125
39FL27K424M	27W	24°	2610	125
39FL27K436M	27W	36°	2610	125
39FL27K450M	27W	50°	2610	125
39FL36K415M	36W	15°	3497	125
39FL36K424M	36W	24°	3497	125
39FL36K436M	36W	36°	3497	125
39FL36K450M	36W	50°	3497	125

Cod.	3000K	Beam Angle	lm	Ø mm
39FL18K315M	18W	15°	1914	125
39FL18K324M	18W	24°	1914	125
39FL18K336M	18W	36°	1914	125
39FL18K350M	18W	50°	1914	125
39FL27K315M	27W	15°	2570	125
39FL27K324M	27W	24°	2570	125
39FL27K336M	27W	36°	2570	125
39FL27K350M	27W	50°	2570	125
39FL36K315M	36W	15°	3448	125
39FL36K324M	36W	24°	3448	125
39FL36K336M	36W	36°	3448	125
39FL36K350M	36W	50°	3448	125

MAKE FL LARGE

Accessories on page 137.

IP 44

Recessed frameless installation with adjustable light source. Polycarbonate lens Ø 83 mm.
Beam angles: 15° - 24° - 36° - 50°.

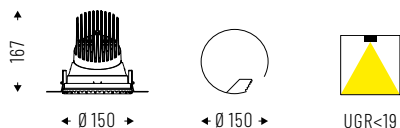

Cod. 4000K	Wattage	Beam angle	lm	Ø mm
39FL25K415L	25W	15°	2553	150
39FL25K424L	25W	24°	2553	150
39FL25K436L	25W	36°	2553	150
39FL25K450L	25W	50°	2553	150
39FL36K415L	36W	15°	3503	150
39FL36K424L	36W	24°	3503	150
39FL36K436L	36W	36°	3503	150
39FL36K450L	36W	50°	3503	150
39FL40K415L	40W	15°	4401	150
39FL40K424L	40W	24°	4401	150
39FL40K436L	40W	36°	4401	150
39FL40K450L	40W	50°	4401	150

Cod. 3000K	Wattage	Beam angle	lm	Ø mm
39FL25K315L	25W	15°	2515	150
39FL25K324L	25W	24°	2515	150
39FL25K336L	25W	36°	2515	150
39FL25K350L	25W	50°	2515	150
39FL36K315L	36W	15°	3402	150
39FL36K324L	36W	24°	3402	150
39FL36K336L	36W	36°	3402	150
39FL36K350L	36W	50°	3402	150
39FL40K315L	40W	15°	4353	150
39FL40K324L	40W	24°	4353	150
39FL40K336L	40W	36°	4353	150
39FL40K350L	40W	50°	4353	150

MAKE DOUBLE MINI

Accessories on page 137.

IP 44

Double adjustable recessed installation.
Polycarbonate lens Ø 35 mm.
Beam angles: 15° - 24° - 36° - 50°.

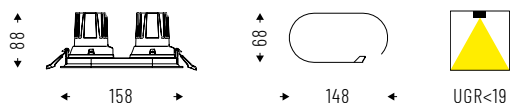

Cod. 4000K	Wattage	Beam angle	lm	L mm
39OR23K415MN	2x3W	15°	706	78x158
39OR23K424MN	2x3W	24°	706	78x158
39OR23K436MN	2x3W	36°	706	78x158
39OR23K450MN	2x3W	50°	706	78x158
39OR26K415MN	2x6W	15°	1200	78x158
39OR26K424MN	2x6W	24°	1200	78x158
39OR26K436MN	2x6W	36°	1200	78x158
39OR26K450MN	2x6W	50°	1200	78x158
39OR21K415MN	2x11W	15°	1794	78x158
39OR21K424MN	2x11W	24°	1794	78x158
39OR21K436MN	2x11W	36°	1794	78x158
39OR21K450MN	2x11W	50°	1794	78x158

Cod. 3000K	Wattage	Beam angle	lm	L mm
39OR23K315MN	2x3W	15°	696	78x158
39OR23K324MN	2x3W	24°	696	78x158
39OR23K336MN	2x3W	36°	696	78x158
39OR23K350MN	2x3W	50°	696	78x158
39OR26K315MN	2x6W	15°	1182	78x158
39OR26K324MN	2x6W	24°	1182	78x158
39OR26K336MN	2x6W	36°	1182	78x158
39OR26K350MN	2x6W	50°	1182	78x158
39OR21K315MN	2x11W	15°	1704	78x158
39OR21K324MN	2x11W	24°	1704	78x158
39OR21K336MN	2x11W	36°	1704	78x158
39OR21K350MN	2x11W	50°	1704	78x158

MAKE DOUBLE SMALL

IP 44

Double adjustable recessed installation.
Polycarbonate lens Ø 50 mm.
Beam angles: 15° - 24° - 36° - 50°.

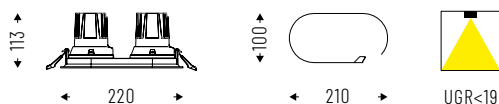

Cod.	4000K	Icon	lm	L mm
39OR29K415S	2x9W 15°		1870	110x220
39OR29K424S	2x9W 24°		1870	110x220
39OR29K436S	2x9W 36°		1870	110x220
39OR29K450S	2x9W 50°		1870	110x220
39OR213K415S	2x13W 15°		2570	110x220
39OR213K424S	2x13W 24°		2570	110x220
39OR213K436S	2x13W 36°		2570	110x220
39OR213K450S	2x13W 50°		2570	110x220
39OR218K415S	2x18W 15°		3650	110x220
39OR218K424S	2x18W 24°		3650	110x220
39OR218K436S	2x18W 36°		3650	110x220
39OR218K450S	2x18W 50°		3650	110x220

Cod.	3000K	Icon	lm	L mm
39OR29K315S	2x9W 15°		1838	110x220
39OR29K324S	2x9W 24°		1838	110x220
39OR29K336S	2x9W 36°		1838	110x220
39OR29K350S	2x9W 50°		1838	110x220
39OR213K315S	2x13W 15°		2526	110x220
39OR213K324S	2x13W 24°		2526	110x220
39OR213K336S	2x13W 36°		2526	110x220
39OR213K350S	2x13W 50°		2526	110x220
39OR218K315S	2x18W 15°		3590	110x220
39OR218K324S	2x18W 24°		3590	110x220
39OR218K336S	2x18W 36°		3590	110x220
39OR218K350S	2x18W 50°		3590	110x220

MAKE DEEP MINI

IP 44

Recessed installation with adjustable light source.
Polycarbonate lens Ø 35 mm.
Beam angles: 15° - 24° - 36° - 50°.

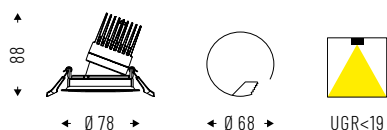

Cod.	4000K	Icon	lm	Ø mm
39AR3K415MN	3W 15°		291	78
39AR3K424MN	3W 24°		291	78
39AR3K436MN	3W 36°		291	78
39AR3K450MN	3W 50°		291	78
39AR6K415MN	6W 15°		500	78
39AR6K424MN	6W 24°		500	78
39AR6K436MN	6W 36°		500	78
39AR6K450MN	6W 50°		500	78
39AR11K415MN	11W 15°		651	78
39AR11K424MN	11W 24°		651	78
39AR11K436MN	11W 36°		651	78
39AR11K450MN	11W 50°		651	78

Cod.	3000K	Icon	lm	Ø mm
39AR3K315MN	3W 15°		287	78
39AR3K324MN	3W 24°		287	78
39AR3K336MN	3W 36°		287	78
39AR3K350MN	3W 50°		287	78
39AR6K315MN	6W 15°		492	78
39AR6K324MN	6W 24°		492	78
39AR6K336MN	6W 36°		492	78
39AR6K350MN	6W 50°		492	78
39AR11K315MN	11W 15°		641	78
39AR11K324MN	11W 24°		641	78
39AR11K336MN	11W 36°		641	78
39AR11K350MN	11W 50°		641	78

MAKE DEEP SMALL

IP 44

Recessed installation with adjustable light source. Polycarbonate lens Ø 50 mm.
Beam angles: 15° - 24° - 36° - 50°.

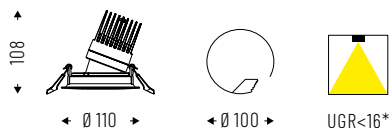

Cod. 4000K	☼	lm	Ø mm
39AR9K415S	9W 15°	831	110
39AR9K424S	9W 24°	831	110
39AR9K436S	9W 36°	831	110
39AR9K450S	9W 50°	831	110
39AR13K415S	13W 15°	1144	110
39AR13K424S	13W 24°	1144	110
39AR13K436S	13W 36°	1144	110
39AR13K450S	13W 50°	1144	110
39AR18K415S	18W 15°	1529	110
39AR18K424S	18W 24°	1529	110
39AR18K436S	18W 36°	1529	110
39AR18K450S	18W 50°	1529	110

Cod. 3000K	☼	lm	Ø mm
39AR9K315S	9W 15°	817	110
39AR9K324S	9W 24°	817	110
39AR9K336S	9W 36°	817	110
39AR9K350S	9W 50°	817	110
39AR13K315S	13W 15°	1124	110
39AR13K324S	13W 24°	1124	110
39AR13K336S	13W 36°	1124	110
39AR13K350S	13W 50°	1124	110
39AR18K315S	18W 15°	1503	110
39AR18K324S	18W 24°	1503	110
39AR18K336S	18W 36°	1503	110
39AR18K350S	18W 50°	1503	110

DOWNLIGHT

ACCESSORIES



External reflector in chromed PC.

- 39RFA** - MICRO
- 39RFAMN** - MINI
- 39RFAS** - SMALL
- 39RFAM** - MEDIUM
- 39RFAL** - LARGE



External reflector in golden PC.

- 39RFG** - MICRO
- 39RFGMN** - MINI
- 39RFGS** - SMALL
- 39RFGM** - MEDIUM
- 39RFGL** - LARGE



Honeycomb optics - UGR < 16.

- 39AAND** - MICRO
- 39AANDMN** - MINI
- 39AANDS** - SMALL
- 39AANDM** - MEDIUM
- 39AANDL** - LARGE



Micro-engraved optics.

- 39AASL** - MICRO
- 39AASLMN** - MINI
- 39AASLS** - SMALL
- 39AASLM** - MEDIUM
- 39AASLL** - LARGE



Frosted glass.

- 39AAVS** - MICRO
- 39AAVSMN** - MINI
- 39AAVSS** - SMALL
- 39AAVSM** - MEDIUM
- 39AAVSL** - LARGE



Ring for UGR < 16 reduction

- 39AAUGR** - MICRO
- 39AAUGRMN** - MINI



MAKE Q

MAKE Q is the new **adjustable square base downlight** developed in different configurations: with edge, frameless, with double spot and recessed optic. Available in micro, mini, small, medium and large sizes, for installation from 50 to 125 mm, it is particularly suitable for **office and retail applications**, where the light source is matched by **strong and pure geometric lines**.





ID 39



FEATURES

-  Direct emission
-  UGR <19
-  IP 44







LED

-  3000K/4000K
- >100 lm/W icon" data-bbox="758 238 788 258"/> >100 lm/W
-  CRI >90
-  Eye safety: R60/R61
-  Mac Adams 3
-  L80/B10 >50.000h

CERTIFICATIONS

-  EEA Conformity
-  Energy efficiency
-  5 years warranty

ON REQUEST

-  DALI - code D
-  Bluetooth - code BT*
-  Emergency 1 hr - code EM
-  Emergency 3 hrs - code EM3R*
-  2700K - code K27*
-  5000K - code K5*

SPECIFICATIONS

Built-in driver.
Polycarbonate lens,
beam: 15°, 24°, 36°, 50°.
Front reflector in polycarbonate.

BODY

Aluminum with epoxy
powder coating.

COLORS

White RAL 9003 wrinkled
- code W
Black RAL 9005 wrinkled
- code BK

*Where available

MAKE Q MICRO

Accessories on page 142.

IP 44

Adjustable recessed installation.
Polycarbonate lens Ø 25 mm.
Beam angles: 15° - 24° - 36° - 50°.

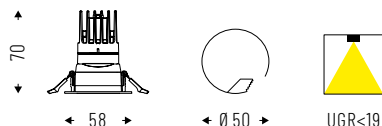

Cod. 4000K	Beam	lm	mm
390Q3K415	3W 15°	375	58x58
390Q3K424	3W 24°	375	58x58
390Q3K436	3W 36°	375	58x58
390Q3K450	3W 50°	375	58x58
390Q6K415	6W 15°	600	58x58
390Q6K424	6W 24°	600	58x58
390Q6K436	6W 36°	600	58x58
390Q6K450	6W 50°	600	58x58
390Q9K415	9W 15°	793	58x58
390Q9K424	9W 24°	793	58x58
390Q9K436	9W 36°	793	58x58
390Q9K450	9W 50°	793	58x58

Cod. 3000K	Beam	lm	mm
390Q3K315	3W 15°	355	58x58
390Q3K324	3W 24°	355	58x58
390Q3K336	3W 36°	355	58x58
390Q3K350	3W 50°	355	58x58
390Q6K315	6W 15°	568	58x58
390Q6K324	6W 24°	568	58x58
390Q6K336	6W 36°	568	58x58
390Q6K350	6W 50°	568	58x58
390Q9K315	9W 15°	752	58x58
390Q9K324	9W 24°	752	58x58
390Q9K336	9W 36°	752	58x58
390Q9K350	9W 50°	752	58x58

MAKE Q MINI

Accessories on page 142.

IP 44

Adjustable recessed installation.
Polycarbonate lens Ø 30 mm.
Beam angles: 15° - 24° - 36° - 50°.

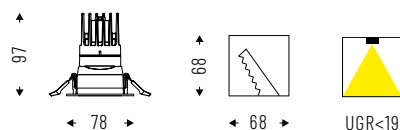

Cod. 4000K	Beam	lm	L mm
390Q3K415MN	3W 15°	353	78x78
390Q3K424MN	3W 24°	353	78x78
390Q3K436MN	3W 36°	353	78x78
390Q3K450MN	3W 50°	353	78x78
390Q6K415MN	6W 15°	600	78x78
390Q6K424MN	6W 24°	600	78x78
390Q6K436MN	6W 36°	600	78x78
390Q6K450MN	6W 50°	600	78x78
390Q11K415MN	11W 15°	897	78x78
390Q11K424MN	11W 24°	897	78x78
390Q11K436MN	11W 36°	897	78x78
390Q11K450MN	11W 50°	897	78x78

Cod. 3000K	Beam	lm	L mm
390Q3K315MN	3W 15°	348	78x78
390Q3K324MN	3W 24°	348	78x78
390Q3K336MN	3W 36°	348	78x78
390Q3K350MN	3W 50°	348	78x78
390Q6K315MN	6W 15°	591	78x78
390Q6K324MN	6W 24°	591	78x78
390Q6K336MN	6W 36°	591	78x78
390Q6K350MN	6W 50°	591	78x78
390Q11K315MN	11W 15°	852	78x78
390Q11K324MN	11W 24°	852	78x78
390Q11K336MN	11W 36°	852	78x78
390Q11K350MN	11W 50°	852	78x78

MAKE Q SMALL

Accessories on page 142.

IP 44

Adjustable recessed installation.
Polycarbonate lens Ø 50 mm.
Beam angles: 15° - 24° - 36° - 50°.



Cod. 4000K	☼	lm	mm
390Q9K415S	9W 15°	935	110x110
390Q9K424S	9W 24	935	110x110
390Q9K436S	9W 36°	935	110x110
390Q9K450S	9W 50°	935	110x110
390Q13K415S	13W 15°	1285	110x110
390Q13K424S	13W 24	1285	110x110
390Q13K436S	13W 36°	1285	110x110
390Q13K450S	13W 50°	1285	110x110
390Q18K415S	18W 15°	1825	110x110
390Q18K424S	18W 24	1825	110x110
390Q18K436S	18W 36°	1825	110x110
390Q18K450S	18W 50°	1825	110x110

Cod. 3000K	☼	lm	mm
390Q9K315S	9W 15°	919	110x110
390Q9K324S	9W 24	919	110x110
390Q9K336S	9W 36°	919	110x110
390Q9K350S	9W 50°	919	110x110
390Q13K315S	13W 15°	1263	110x110
390Q13K324S	13W 24	1263	110x110
390Q13K336S	13W 36°	1263	110x110
390Q13K350S	13W 50°	1263	110x110
390Q18K315S	18W 15°	1795	110x110
390Q18K324S	18W 24	1795	110x110
390Q18K336S	18W 36°	1795	110x110
390Q18K350S	18W 50°	1795	110x110

MAKE Q MEDIUM

Accessories on page 142.

IP 44

Adjustable recessed installation.
Polycarbonate lens Ø 75 mm.
Beam angles: 15° - 24° - 36° - 50° - 70°.

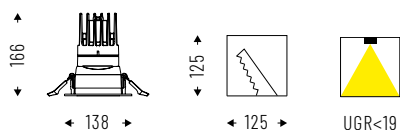

Cod. 4000K	☼	lm	L mm
390Q18K415M	18W 15°	1944	138x138
390Q18K424M	18W 24°	1944	138x138
390Q18K436M	18W 36°	1944	138x138
390Q18K450M	18W 50°	1944	138x138
390Q27K415M	27W 15°	2610	138x138
390Q27K424M	27W 24°	2610	138x138
390Q27K436M	27W 36°	2610	138x138
390Q27K450M	27W 50°	2610	138x138
390Q36K415M	36W 15°	3497	138x138
390Q36K424M	36W 24°	3497	138x138
390Q36K436M	36W 36°	3497	138x138
390Q36K450M	36W 50°	3497	138x138

Cod. 3000K	☼	lm	L mm
390Q18K315M	18W 15°	1914	138x138
390Q18K324M	18W 24°	1914	138x138
390Q18K336M	18W 36°	1914	138x138
390Q18K350M	18W 50°	1914	138x138
390Q27K315M	27W 15°	2570	138x138
390Q27K324M	27W 24°	2570	138x138
390Q27K336M	27W 36°	2570	138x138
390Q27K350M	27W 50°	2570	138x138
390Q36K315M	36W 15°	3448	138x138
390Q36K324M	36W 24°	3448	138x138
390Q36K336M	36W 36°	3448	138x138
390Q36K350M	36W 50°	3448	138x138

MAKE Q DOUBLE MICRO

Accessories on page 142.

IP 44

Double adjustable recessed installation.
Polycarbonate lens Ø 25 mm.
Beam angles: 15° - 24° - 36° - 50°.

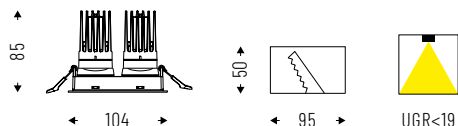

Cod.	4000K	Beam angle	lm	L mm
390Q23K415	2x3W 15°	750	57x104	
390Q23K424	2x3W 24°	750	57x104	
390Q23K436	2x3W 36°	750	57x104	
390Q23K450	2x3W 50°	750	57x104	
390Q26K415	2x6W 15°	1200	57x104	
390Q26K424	2x6W 24°	1200	57x104	
390Q26K436	2x6W 36°	1200	57x104	
390Q26K450	2x6W 50°	1200	57x104	
390Q29K415	2x9W 15°	1586	57x104	
390Q29K424	2x9W 24°	1586	57x104	
390Q29K436	2x9W 36°	1586	57x104	
390Q29K450	2x9W 50°	1586	57x104	

Cod.	3000K	Beam angle	lm	L mm
390Q23K315	2x3W 15°	750	57x104	
390Q23K324	2x3W 24°	750	57x104	
390Q23K336	2x3W 36°	750	57x104	
390Q23K350	2x3W 50°	750	57x104	
390Q26K315	2x6W 15°	1200	57x104	
390Q26K324	2x6W 24°	1200	57x104	
390Q26K336	2x6W 36°	1200	57x104	
390Q26K350	2x6W 50°	1200	57x104	
390Q29K315	2x9W 15°	1586	57x104	
390Q29K324	2x9W 24°	1586	57x104	
390Q29K336	2x9W 36°	1586	57x104	
390Q29K350	2x9W 50°	1586	57x104	

MAKE Q DOUBLE MINI

Accessories on page 142.

IP 44

Double adjustable recessed installation.
Polycarbonate lens Ø 35 mm.
Beam angles: 15° - 24° - 36° - 50°.

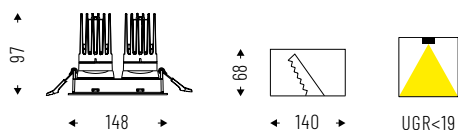

Cod.	4000K	Beam angle	lm	L mm
390Q23K415MN	2x3W 15°	706	78x148	
390Q23K424MN	2x3W 24°	706	78x148	
390Q23K436MN	2x3W 36°	706	78x148	
390Q23K450MN	2x3W 50°	706	78x148	
390Q26K415MN	2x6W 15°	1200	78x148	
390Q26K424MN	2x6W 24°	1200	78x148	
390Q26K436MN	2x6W 36°	1200	78x148	
390Q26K450MN	2x6W 50°	1200	78x148	
390Q211K415MN	2x11W 15°	1794	78x148	
390Q211K424MN	2x11W 24°	1794	78x148	
390Q211K436MN	2x11W 36°	1794	78x148	
390Q211K450MN	2x11W 50°	1794	78x148	

Cod.	3000K	Beam angle	lm	L mm
390Q23K315MN	2x3W 15°	696	78x148	
390Q23K324MN	2x3W 24°	696	78x148	
390Q23K336MN	2x3W 36°	696	78x148	
390Q23K350MN	2x3W 50°	696	78x148	
390Q26K315MN	2x6W 15°	1182	78x148	
390Q26K324MN	2x6W 24°	1182	78x148	
390Q26K336MN	2x6W 36°	1182	78x148	
390Q26K350MN	2x6W 50°	1182	78x148	
390Q211K315MN	2x11W 15°	1704	78x148	
390Q211K324MN	2x11W 24°	1704	78x148	
390Q211K336MN	2x11W 36°	1704	78x148	
390Q211K350MN	2x11W 50°	1704	78x148	

MAKE Q DOUBLE SMALL

IP 44

Double adjustable recessed installation.
Polycarbonate lens Ø 50 mm.
Beam angles: 15° - 24° - 36° - 50°.

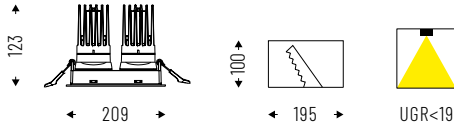

Cod. 4000K	Beam	lm	L mm
390Q29K415S	2x9W 15°	1870	110x209
390Q29K424S	2x9W 24°	1870	110x209
390Q29K436S	2x9W 36°	1870	110x209
390Q29K450S	2x9W 50°	1870	110x209
390Q213K415S	2x13W 15°	2570	110x209
390Q213K424S	2x13W 24°	2570	110x209
390Q213K436S	2x13W 36°	2570	110x209
390Q213K450S	2x13W 50°	2570	110x209
390Q218K415S	2x18W 15°	3650	110x209
390Q218K424S	2x18W 24°	3650	110x209
390Q218K436S	2x18W 36°	3650	110x209
390Q218K450S	2x18W 50°	3650	110x209

Cod. 3000K	Beam	lm	L mm
390Q29K315S	2x9W 15°	1838	110x209
390Q29K324S	2x9W 24°	1838	110x209
390Q29K336S	2x9W 36°	1838	110x209
390Q29K350S	2x9W 50°	1838	110x209
390Q213K315S	2x13W 15°	2526	110x209
390Q213K324S	2x13W 24°	2526	110x209
390Q213K336S	2x13W 36°	2526	110x209
390Q213K350S	2x13W 50°	2526	110x209
390Q218K315S	2x18W 15°	3590	110x209
390Q218K324S	2x18W 24°	3590	110x209
390Q218K336S	2x18W 36°	3590	110x209
390Q218K350S	2x18W 50°	3590	110x209

ACCESSORIES



External reflector in chromed PC.

- 39RFQA** - MICRO
- 39RFQAMN** - MINI
- 39RFQAS** - SMALL
- 39RFQAM** - MEDIUM



External reflector in golden PC.

- 39RFQG** - MICRO
- 39RFQGMN** - MINI
- 39RFQGS** - SMALL
- 39RFQGM** - MEDIUM



Honeycomb optics - UGR < 16.

- 39AAND** - MICRO
- 39AANDMN** - MINI
- 39AANDS** - SMALL
- 39AANDM** - MEDIUM



Micro-engraved optics.



- 39AASL** - MICRO
- 39AASLMN** - MINI
- 39AASLS** - SMALL
- 39AASLM** - MEDIUM









Frosted glass.

- 39AAVS** - MICRO
- 39AAVSMN** - MINI
- 39AAVSS** - SMALL
- 39AAVSM** - MEDIUM

FEATURES

-  Direct emission
-  UGR <16**; <19
-  IP 44





LED

-  3000K/4000K
-  >100 lm/W
-  CRI >90
-  Eye safety: R60/R61
-  Mac Adams 3
-  L80/B10 >50.000h

CERTIFICATIONS

-  EEA Conformity
-  Energy efficiency
-  5 years warranty

ON REQUEST

-  DALI - code D
-  Bluetooth - code BT*
-  Emergency 1 hr - code EM
Emergency 3 hrs - code EM3R*
-  2700K - code K27*
5000K - code K5*

SPECIFICATIONS

Built-in driver.
Polycarbonate lens,
beam angles: 15°, 24°, 36°, 50°.
Front reflector in polycarbonate.

BODY

Aluminum with epoxy
powder coating.

COLORS

White RAL 9003 wrinkled
- code W
Black RAL 9005 wrinkled
- code BK

*Where available.

**With accessory 39A11GR



DOWNLIGHT

MAKE R is the new **swiveling and adjustable downlight**. Available in mini, small and medium size, with various diameter possibilities, it can be equipped with narrow or wide beam optics. The free rotating body can be partially **extracted and tilted** or **remain completely recessed**, making **MAKE R** extremely **versatile for office, retail** and all those installations that require **dynamic lighting**.

ID 39

MAKE R ^{MINI}

Accessories on page 146.

IP 44

Adjustable and swiveling recessed installation.

Polycarbonate lens Ø 35 mm.

Beam: 24° - 36° - 50°.

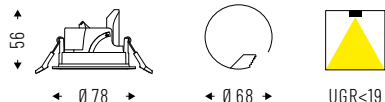

Cod. 4000K	☼	lm	Ø mm
390A3K424MN	3W 24°	420	78
390A3K436MN	3W 36°	420	78
390A3K450MN	3W 50°	420	78
390A6K424MN	6W 24°	700	78
390A6K436MN	6W 36°	700	78
390A6K450MN	6W 50°	700	78

Cod. 3000K	☼	lm	Ø mm
390A3K324MN	3W 24°	374	78
390A3K336MN	3W 36°	374	78
390A3K350MN	3W 50°	374	78
390A6K324MN	6W 24°	623	78
390A6K336MN	6W 36°	623	78
390A6K350MN	6W 50°	623	78

MAKE R ^{SMALL}

Accessories on page 146.

IP 44

Adjustable and swiveling recessed installation.

Polycarbonate lens Ø 50 mm.

Beam: 15° - 24° - 36° - 50°.

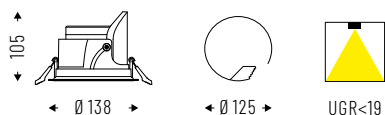

Cod. 4000K	☼	lm	Ø mm
390A12K415S	12W 15°	1560	138
390A12K424S	12W 24°	1560	138
390A12K436S	12W 36°	1560	138
390A12K450S	12W 50°	1560	138
390A17K415S	17W 15°	2200	138
390A17K424S	17W 24°	2200	138
390A17K436S	17W 36°	2200	138
390A17K450S	17W 50°	2200	138
390A24K415S	24W 15°	3000	138
390A24K424S	24W 24°	3000	138
390A24K436S	24W 36°	3000	138
390A24K450S	24W 50°	3000	138

Cod. 3000K	☼	lm	Ø mm
390A12K315S	12W 15°	1388	138
390A12K324S	12W 24°	1388	138
390A12K336S	12W 36°	1388	138
390A12K350S	12W 50°	1388	138
390A17K315S	17W 15°	1958	138
390A17K324S	17W 24°	1958	138
390A17K336S	17W 36°	1958	138
390A17K350S	17W 50°	1958	138
390A24K315S	24W 15°	2670	138
390A24K324S	24W 24°	2670	138
390A24K336S	24W 36°	2670	138
390A24K350S	24W 50°	2670	138

MAKE R MEDIUM

Accessories on page 146.

IP 44

Adjustable and swiveling recessed installation.

Polycarbonate lens Ø 75 mm.

Beam: 15° - 24° - 36° - 50°.

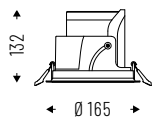

Cod. 4000K	☼	lm	Ø mm
390A17K415M	17W 15°	2020	165
390A17K424M	17W 24°	2020	165
390A17K436M	17W 36°	2020	165
390A17K450M	17W 50°	2020	165
390A24K415M	24W 15°	2850	165
390A24K424M	24W 24°	2850	165
390A24K436M	24W 36°	2850	165
390A24K450M	24W 50°	2850	165
390A31K415M	31W 15°	3700	165
390A31K424M	31W 24°	3700	165
390A31K436M	31W 36°	3700	165
390A31K450M	31W 50°	3700	165

Cod. 3000K	☼	lm	Ø mm
390A17K315M	17W 15°	1798	165
390A17K324M	17W 24°	1798	165
390A17K336M	17W 36°	1798	165
390A17K350M	17W 50°	1798	165
390A24K315M	24W 15°	2537	165
390A24K324M	24W 24°	2537	165
390A24K336M	24W 36°	2537	165
390A24K350M	24W 50°	2537	165
390A31K315M	31W 15°	3293	165
390A31K324M	31W 24°	3293	165
390A31K336M	31W 36°	3293	165
390A31K350M	31W 50°	3293	165

DOWNLIGHT

ACCESSORIES



External reflector in chromed PC.

- 39RFRAMN** - MINI
- 39RFRAS** - SMALL
- 39RFRAM** - MEDIUM



External reflector in golden PC.

- 39RFRGMN** - MINI
- 39RFRGS** - SMALL
- 39RFRGM** - MEDIUM



Honeycomb optics - UGR < 16.

- 39AANDRMN** - MINI
- 39AANDRS** - SMALL
- 39AANDRM** - MEDIUM



Micro-engraved optics.

- 39AASLRMN** - MINI
- 39AASLRS** - SMALL
- 39AASLRM** - MEDIUM



Frosted glass.

- 39AAVSRMN** - MINI
- 39AAVSRS** - SMALL
- 39AAVSRM** - MEDIUM

FEATURES

 Direct emission

 UGR <19

 IP 40

LED

 3000K/4000K

 >80 lm/W

 CRI >90

 Eye safety: R60/R61

 Mac Adams 3

 L80/B10 >50.000h

CERTIFICATIONS

 EEA Conformity

 Energy efficiency

 5 years warranty

ON REQUEST

 DALI - code D

 2700K - code K27*

SPECIFICATIONS

Built-in driver.
Lente con fascio regolabile
da 10° a 40°.
Ottica a nido d'aape.

BODY

Aluminum with epoxy
powder coating.

COLORS

White RAL 9003 wrinkled
- code W
Black RAL 9005 wrinkled
- code BK

* Where available

TERES MICRO ZOOM RECESSED

TERES MICRO ZOOM RECESSED is the new **directional recessed spotlight** with extremely small dimensions and high performance: in only 65 mm per 31mm of diameter is concentrated a spot with **adjustable beam lens** (from 10° to 40°) perfect for an accent light in those areas where the presence of the fixture must be discreet. Available in recessed versions with visible frame or frameless, single or with multiple spots.

ID 14



TERES MICRO ZOOM RECESSED

IP 40

Adjustable beam angles lens: from 10° to 40°.
For recessed installation.

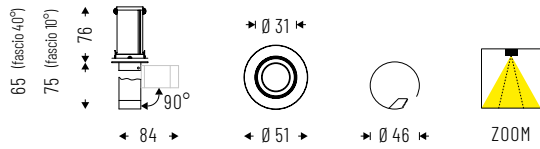

Cod. 4000K		lm	Ø mm
14ZM3K4NR	3W	262	51
14ZM7K4NR	7W	560	51

Cod. 3000K		lm	Ø mm
14ZM3K3NR	3W	238	51
14ZM7K3NR	7W	510	51

TERES MICRO ZOOM RECESSED FRAMELESS

IP 40

Adjustable beam angles lens: from 10° to 40°.
For recessed frameless installation.



Cod. 4000K		lm	Ø mm
14ZM3K4NF	3W	262	31
14ZM7K4NF	7W	560	31

Cod. 3000K		lm	Ø mm
14ZM3K3NF	3W	238	31
14ZM7K3NF	7W	510	31

TERES MICRO ZOOM RECESSED 2X

IP 40

Double adjustable beam angles lens: from 10° to 40°.
For recessed installation.

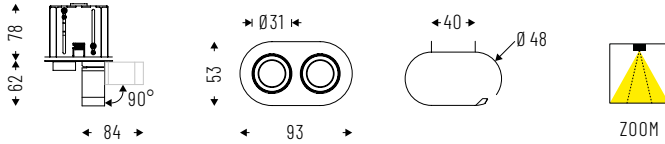

Cod. 4000K	☼	lm	mm
14ZM23K4NR	2X3W	524	53x93
14ZM27K4NR	2X7W	1120	53x93

Cod. 3000K	☼	lm	mm
14ZM23K3NR	2X3W	476	53x93
14ZM27K3NR	2X7W	1020	53x93

DOWNLIGHT

TECHNICAL NOTES



ADJUSTMENT AND AIMING

FULLY RECESSED POSITION



AIMING AND ZOOM POSITION



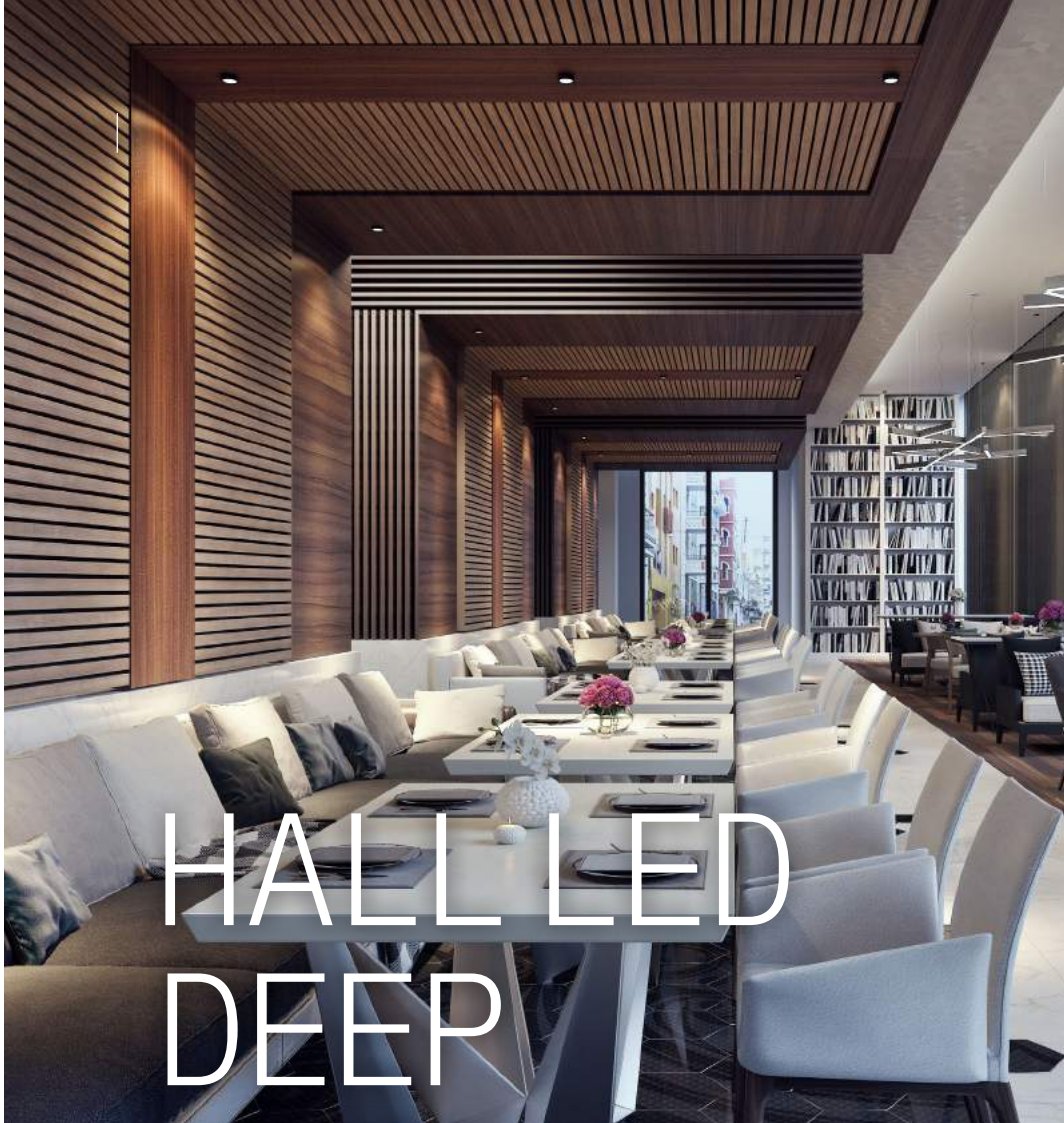





HALL LED DEEP

Miniature downlight for discrete accent lighting, **designed to express the best of the latest LED technology.** Modern and compact, **HALL LED DEEP** is the ideal fixture for restaurants, meeting rooms and commercial spaces where the light needs to be of high quality yet discrete in appearance.







ID 38



FEATURES

-  Direct emission
-  UGR <19
-  IP 44
-  IK 02





LED

-  3000K/4000K
-  >60 lm/W; >103 lm/W
-  CRI >90
-  Eye safety: R60/R61
-  Mac Adams 3
-  L80/B10 >50.000h

CERTIFICATIONS

-  EEA Conformity
-  Energy efficiency
-  5 years warranty

ON REQUEST

-  DALI - code D*
-  Bluetooth - code BT*
-  Emergency 1 hr - code EM*
Emergency 3 hrs - code EM3R*
-  2700K - code K27*
5000K - code K5*

SPECIFICATIONS

Built-in driver.
MINI: polycarbonate lens.
SMALL: internal aluminum reflector,
beam angle: 25°- 40°

BODY

Aluminum with epoxy powder coating.

COLORS

White RAL 9003 matte - code B
Black RAL 9005 matte - code C8

*Verificare disponibilità

HALL LED DEEP ^{MINI}

IP 44

Polycarbonate lens.

Beam angles: 8° - 12° - 36°.

CUT OFF: > 60°.

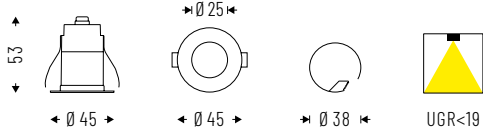

Cod. 4000K	☼	lm	Ø mm
38VM3K48	3W 8°	178	45
38VM3K412	3W 12°	178	45
38VM3K436	3W 36°	178	45

Cod. 3000K	☼	lm	Ø mm
38VM3K38	3W 8°	165	45
38VM3K312	3W 12°	165	45
38VM3K336	3W 36°	165	45

DOWNLIGHT

HALL LED DEEP ^{SMALL}

IP 44

Internal reflector in aluminum with

microprismatic glass. Beam angles: 25° - 40°.

CUT OFF > 40°

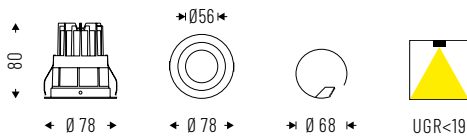

Cod. 4000K	☼	lm	Ø mm
38VM13K425	13W 25°	1339	78
38VM13K440	13W 40°	1339	78

Cod. 3000K	☼	lm	Ø mm
38VM13K325	13W 25°	1205	78
38VM13K340	13W 40°	1205	78

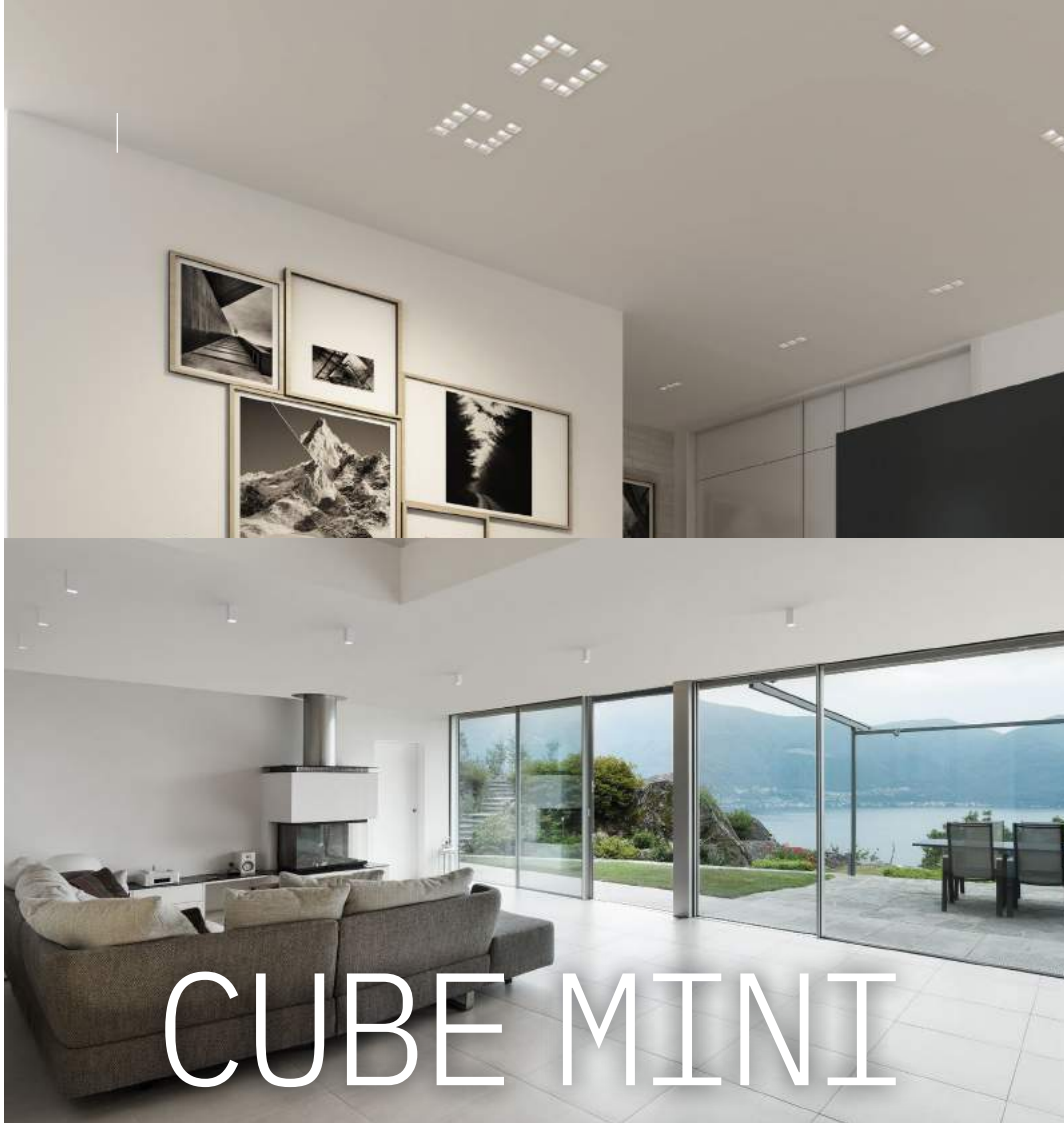



CUBE MINI

CUBE MINI belongs to a range of **small-sized luminaires for both recessed and ceiling applications**. The innovative joint system allows to break down any installation scheme, satisfying the architectural needs of any project. **The body cut-off eliminates the perception of glare** and improves visual comfort.







ID 49



FEATURES

-  Direct emission
-  UGR <19; <22
-  IP 40



LED

-  3000K/4000K
-  >90 lm/W
-  CRI >90
-  Eye safety: R60/R61
-  Mac Adams 3
-  L80/B10 >50.000h

CERTIFICATIONS

-  EEA Conformity
-  Energy efficiency
-  5 years warranty

ON REQUEST

-  DALI - code D*
-  Bluetooth - code BT*
-  Emergency 1 hr - code EM*
Emergency 3 hrs - code EM3R*

SPECIFICATIONS

Built-in driver.
Satin PC primary screen, UGR <19.
PG version with additional coplanar screen in opaline PC, UGR <22.

BODY

Die-cast aluminium.

COLORS

White RAL 9003 matte - code B
Black RAL 9005 matte - code C8

*Verificare disponibilità

CUBE MINI RECESSED

Accessories on page 154.

IP 40

Primary diffuser in frosted PC, UGR<19.

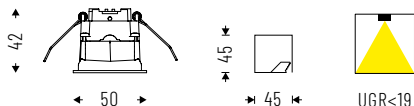

Cod. 4000K		lm	L mm
49DR5K4	5W	459	50
49DR8K4	8W	729	50

Cod. 3000K		lm	L mm
49DR5K3	5W	418	50
49DR8K3	8W	663	50

DOWNLIGHT

CUBE MINI CEILING

Accessories on page 154.

IP 40

Primary diffuser in frosted PC, UGR<19.

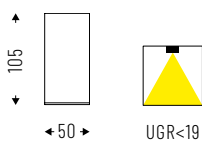

Cod. 4000K		lm	L mm
49DR5K4C	5W	459	50
49DR8K4C	8W	729	50

Cod. 3000K		lm	L mm
49DR5K3C	5W	418	50
49DR8K3C	8W	663	50

ACCESSORIES



Additional coplanar screen in opaline PC, UGR <22.

49AAPG



Bracket for multiple recessed installation.

49AA11



TECHNICAL NOTES



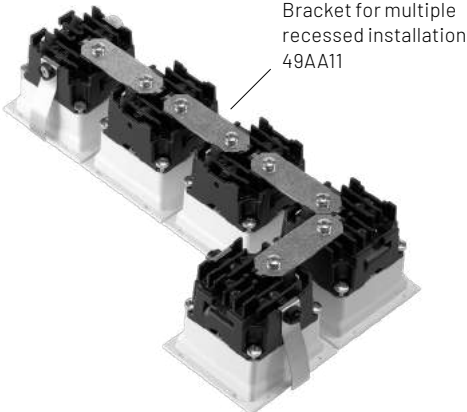





MULTIPLE INSTALLATION



FEATURES

-  Direct emission
-  UGR <19
-  IP 54 (frontalmente)



LED

-  3000K/4000K
-  >100 lm/W
-  CRI >90
-  Eye safety: R60/R61
-  Mac Adams 3
-  L80/B10 >50.000h

CERTIFICATIONS

-  EEA Conformity
-  Energy efficiency
-  5 years warranty

ON REQUEST

-  DALI - code D
-  Bluetooth - code BT*
-  Emergency 1 hr - code EM*
Emergency 3 hrs - code EM3H*

SPECIFICATIONS

Driver included.
SMD LED technology.
Internal reflector in white polycarbonate.
Diffuser in opal microprismatic polycarbonate.
Cut-off >20°

BODY

Die-cast aluminum

COLORS

White RAL 9010 matte - code B
Black RAL 9005 matte - code C8

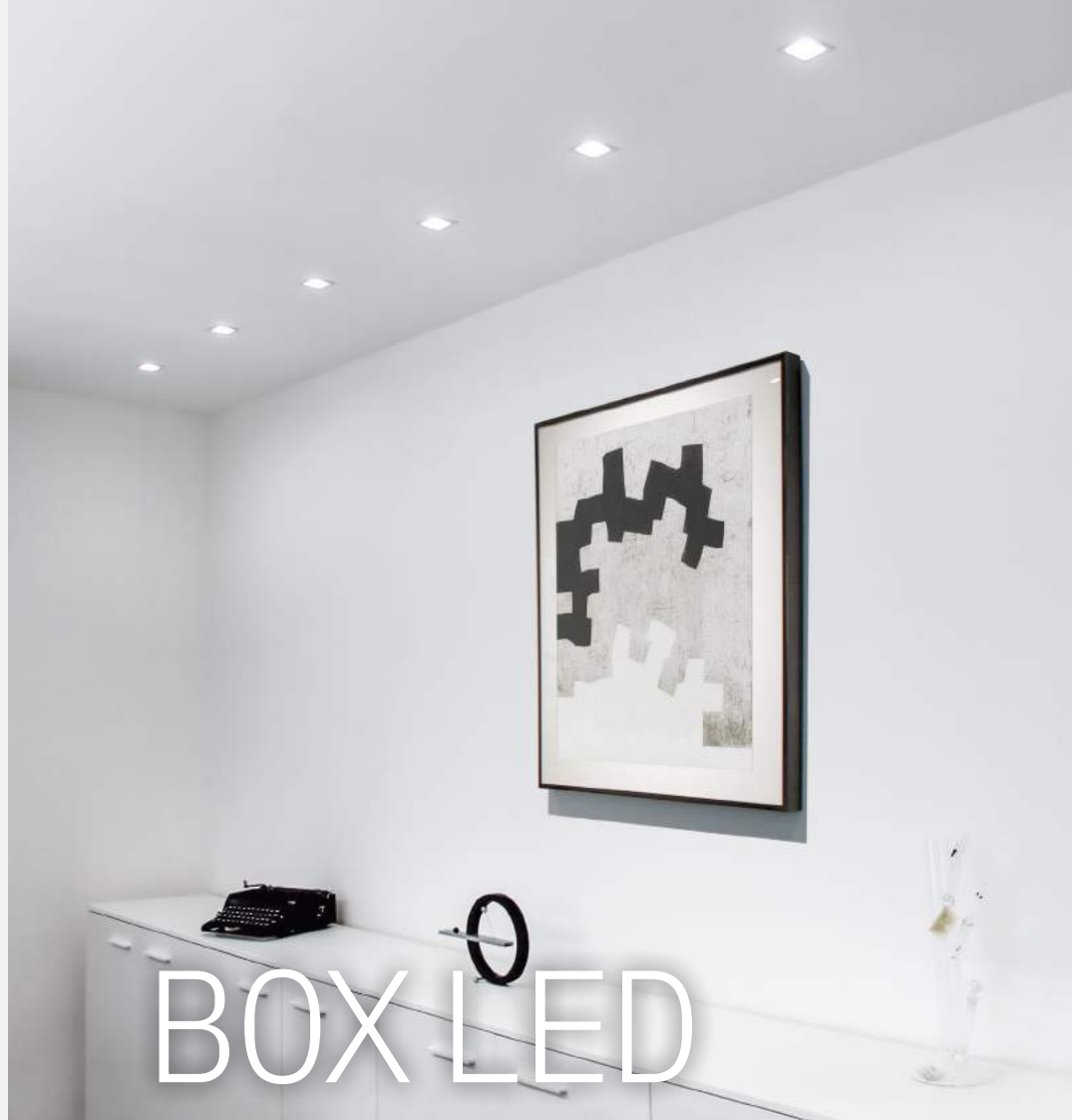

DOWNLIGHT

BOX LED is a line of architectural design luminaires for recessed installation, entirely made of **die-cast aluminum**. Available in three sizes, it offers an incredible variety of powers and lumen packages suitable for any type of environment. The innovative design of the recessed part allows **unparalleled ease of installation: BOX LED** in fact fits into a round hole, facilitating the installation and alignment phase.

ID 44



* Where available

arlico

www.arlico.co.uk » +44 (0) 23 8202 2100 » refer to our website for the complete product range

BOX LED ^{MINI}

IP 54

Internal polycarbonate reflector and opal microprism polycarbonate diffuser.
CUT OFF > 20°.

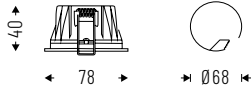

Cod. 4000K	W	lm	L mm
44MP7K454	7W	705	78
44MP10K454	10W	958	78

Cod. 3000K	W	lm	L mm
44MP7K354	7W	656	78
44MP10K354	10W	891	78

BOX LED ^{SMALL}

IP 54

Internal polycarbonate reflector and opal microprism polycarbonate diffuser.
CUT OFF > 20°.

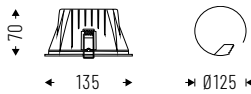

Cod. 4000K	W	lm	L mm
44MP14K4S54	14W	1550	135
44MP20K4S54	20W	2085	135

Cod. 3000K	W	lm	L mm
44MP14K3S54	14W	1500	135
44MP20K3S54	20W	2027	135

BOX LED MEDIUM

IP 54

Internal polycarbonate reflector and opal microprism polycarbonate diffuser.
CUT OFF > 20°.



Cod. 4000K	W	lm	L mm
44MP20K4M54	20W	2223	188
44MP32K4M54	32W	3291	188
44MP48K4M54	48W	4469	188

Cod. 3000K	W	lm	L mm
44MP20K3M54	20W	2184	188
44MP32K3M54	32W	3273	188
44MP48K3M54	48W	4450	188

DOWNLIGHT

TECHNICAL NOTES



CIRCULAR CUT-OUT DIMENSIONS



W	Ø mm
7W - 10W	68
20W - 28W	125
20W - 32W - 48W	175

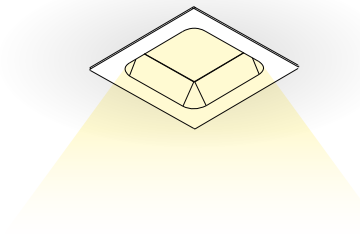
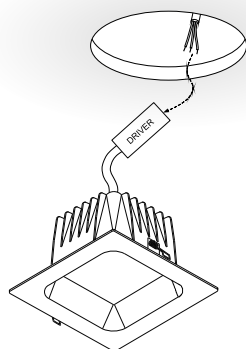





HALL LED PRO

HALL LED PRO is the ideal downlight in commercial and civil environments, thanks to the **eco friendly Chip-on-Board (CoB) technology**, together with low maintenance costs and the **absence of IR and UV emissions**. Available in two diameters, it is ideal for illuminating entrances, large spaces and creating scenographic effects with great visual comfort, thanks to glare control with UGR <19.





ID 38



FEATURES

-  Direct emission
-  UGR <19
-  IP 44
-  IK 02







LED

-  3000K/4000K
- >103 lm/W icon" data-bbox="758 264 788 284"/> >103 lm/W
-  CRI >90
-  Eye safety: R60/R61
-  Mac Adams 3
-  L80/B10 >50.000h

CERTIFICATIONS

-  EEA Conformity
-  Energy efficiency
-  5 years warranty

ON REQUEST

-  DALI - code D
-  Bluetooth - code BT*
-  Emergency 1 hr - code EM
-  Emergency 3 hrs - code EM3H*
-  2700K - code K27*
-  5000K - code K5*

SPECIFICATIONS

Built-in driver.
CoB LED technology,
Internal aluminum reflectors
with beam: 10° - 20° - 40° - 70°
UGR <19 glare control.

BODY

Aluminum with epoxy
powder coating.

COLORS

White RAL 9003 matte - code B
Black RAL 9005 - code C8

* Where available

HALL LED PRO ^{MINI}

IP 44

Polycarbonate reflector with anti-glare design.
Beam angle: 40°. CUT OFF > 30°.



Cod. 4000K	☼	lm	Ø mm
38VT7K440	7W 40°	775	76
38VT10K440	10W 40°	886	76

Cod. 3000K	☼	lm	Ø mm
38VT7K340	7W 40°	595	76
38VT10K340	10W 40°	704	76

DOWNLIGHT

HALL LED PRO ^{SMALL}

IP 44

Internal aluminum reflectors with transparent glass.
Beam angles: 10° - 20° - 40° - 70°.
CUT OFF > 30°.

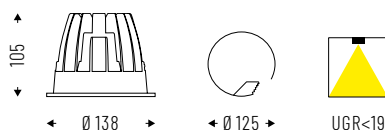

Cod. 4000K	☼	lm	Ø mm
38VT18K410S	18W 10°	2009	138
38VT18K420S	18W 20°	2009	138
38VT18K440S	18W 40°	2009	138
38VT18K470S	18W 70°	2009	138
38VT25K410S	25W 10°	2660	138
38VT25K420S	25W 20°	2660	138
38VT25K440S	25W 40°	2660	138
38VT25K470S	25W 70°	2660	138
38VT34K410S	34W 10°	3492	138
38VT34K420S	34W 20°	3492	138
38VT34K440S	34W 40°	3492	138
38VT34K470S	34W 70°	3492	138

Cod. 3000K	☼	lm	Ø mm
38VT18K310S	18W 10°	1808	138
38VT18K320S	18W 20°	1808	138
38VT18K340S	18W 40°	1808	138
38VT18K370S	18W 70°	1808	138
38VT25K310S	25W 10°	2394	138
38VT25K320S	25W 20°	2394	138
38VT25K340S	25W 40°	2394	138
38VT25K370S	25W 70°	2394	138
38VT34K310S	34W 10°	3178	138
38VT34K320S	34W 20°	3178	138
38VT34K340S	34W 40°	3178	138
38VT34K370S	34W 70°	3178	138

HALL LED PRO MEDIUM

IP 44

Internal aluminum reflectors with transparent glass.
 Beam angles: 10° - 20° - 40° - 70°.
 CUT OFF > 30°.

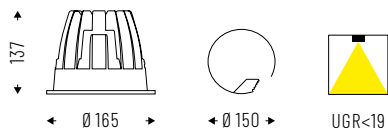

Cod. 4000K	☼	lm	Ø mm
38VT35K410M	35W 10°	3595	165
38VT35K420M	35W 20°	3595	165
38VT35K440M	35W 40°	3595	165
38VT35K470M	35W 70°	3595	165
38VT38K410M	38W 10°	4030	165
38VT38K420M	38W 20°	4030	165
38VT38K440M	38W 40°	4030	165
38VT38K470M	38W 70°	4030	165
38VT52K410M	52W 10°	4992	165
38VT52K420M	52W 20°	4992	165
38VT52K440M	52W 40°	4992	165
38VT52K470M	52W 70°	4992	165

Cod. 3000K	☼	lm	Ø mm
38VT35K310M	35W 10°	3236	165
38VT35K320M	35W 20°	3236	165
38VT35K340M	35W 40°	3236	165
38VT35K370M	35W 70°	3236	165
38VT38K310M	38W 10°	3627	165
38VT38K320M	38W 20°	3627	165
38VT38K340M	38W 40°	3627	165
38VT38K370M	38W 70°	3627	165
38VT52K310M	52W 10°	4784	165
38VT52K320M	52W 20°	4784	165
38VT52K340M	52W 40°	4784	165
38VT52K370M	52W 70°	4784	165

HALL LED PRO LARGE

IP 44

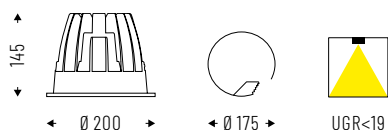

Internal aluminum reflectors with transparent glass.
 Beam angles: 10° - 20° - 40° - 70°.
 CUT OFF > 30°.









Cod. 4000K	☼	lm	Ø mm
38VT38K410L	38W 10°	4030	200
38VT38K420L	38W 20°	4030	200
38VT38K440L	38W 40°	4030	200
38VT38K470L	38W 70°	4030	200
38VT52K410L	52W 10°	4992	200
38VT52K420L	52W 20°	4992	200
38VT52K440L	52W 40°	4992	200
38VT52K470L	52W 70°	4992	200

Cod. 3000K	☼	lm	Ø mm
38VT38K310L	38W 10°	3627	200
38VT38K320L	38W 20°	3627	200
38VT38K340L	38W 40°	3627	200
38VT38K370L	38W 70°	3627	200
38VT52K310L	52W 10°	4784	200
38VT52K320L	52W 20°	4784	200
38VT52K340L	52W 40°	4784	200
38VT52K370L	52W 70°	4784	200

FEATURES

-  Direct emission
-  UGR <19
-  IP 54 (frontalmente)



LED

-  3000K/4000K
-  >105 lm/W
-  CRI >90
-  Eye safety: R60/R61
-  Mac Adams 3
-  L80/B10 >50.000h

CERTIFICATIONS

-  EEA Conformity
-  Energy efficiency
-  5 years warranty

ON REQUEST

-  DALI - code D
-  Bluetooth - code BT*
-  Emergency 1 hr - code EM
Emergency 3 hrs - code EM3H*

SPECIFICATIONS

SMD LED technology.
Built-in driver.
Internal reflector in microcell polycarbonate.
Microprismatic opaline polycarbonate diffuser.
Cut-off >10°

BODY

Polycarbonate, with heat sink in die-cast aluminum.

COLORS

White RAL 9003 matte - code B



DOWNLIGHT

HALL LED ESSENTIAL is perfect for **retrofit applications** where price and efficacy are of equal importance. It can easily replace 18W-26W CFL downlight, with installations on 175mm to 230mm diameter holes.

ID 38



*Verificare disponibilità

arico

www.arico.co.uk » +44 (0) 23 8202 2100 » refer to our website for the complete product range

HALL LED ESSENTIAL MEDIUM

IP 54

Microcell polycarbonate internal reflector and opal microprism polycarbonate diffuser UGR<19.
CUT OFF > 10°.

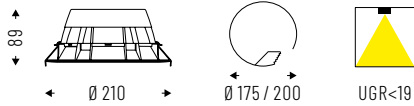

Cod. 4000K	W	lm	Ø mm
38MP9K4M54	9W	1400	210
38MP14K4M54	14W	2100	210
38MP20K4M54	20W	2700	210
38MP26K4M54	26W	3422	210

Cod. 3000K	W	lm	Ø mm
38MP9K3M54	9W	1386	210
38MP14K3M54	14W	2080	210
38MP20K3M54	20W	2680	210
38MP26K3M54	26W	3355	210

HALL LED ESSENTIAL LARGE

IP 54

Microcell polycarbonate internal reflector and opal microprism polycarbonate diffuser UGR<19.
CUT OFF > 10°.

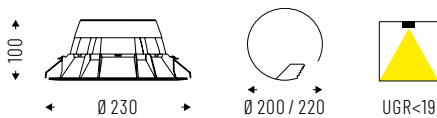

Cod. 4000K	W	lm	Ø mm
38MP9K4L54	9W	1400	230
38MP14K4L54	14W	2100	230
38MP20K4L54	20W	2700	230
38MP26K4L54	26W	3422	230

Cod. 3000K	W	lm	Ø mm
38MP9K3L54	9W	1386	230
38MP14K3L54	14W	2080	230
38MP20K3L54	20W	2680	230
38MP26K3L54	26W	3355	230

FEATURES

 Direct emission

 UGR <19

 IP 40

 IK 02

LED

 3000K/4000K

 >135 lm/W

 CRI >90

 Eye safety: R60/R61

 Mac Adams 3

 L80/B10 >50.000h

CERTIFICATIONS

 EEA Conformity

 Energy efficiency

 5 years warranty

ON REQUEST

 DALI - code D

 Bluetooth - code BT*

 Emergency 1 hr - code EM
Emergency 3 hrs - code EM3H*

 2700K - code K27*
5000K - code K5*

 Frameless version*

SPECIFICATIONS

Built-in driver.
CoB LED technology.
Riflettori interni in alluminio.
Beam angles: 12° - 20° - 40° - 70°.

BODY

Folded metal sheet.
Spotlights in die-cast aluminum.

COLORS

White RAL 9003 - code B



DOWNLIGHT

OTELLO LED provides a new design and a wide choice of versions, to **create custom recessed LED luminaires**. Simple and fast installation, maximum efficiency, symmetrical and homogeneous light distribution are offered as standard. The choice of beam angles is made possible through interchangeable reflectors, and versions with 1 to 3 heads are available, enabling the designer to use the product for both accent and ambient lighting. **OTELLO LED**, perfect for any contemporary application.

ID 45



*Verificare disponibilità

arlico

www.arlico.co.uk » +44 (0) 23 8202 2100 » refer to our website for the complete product range

OTELLO LED 1X

IP 40

Internal aluminum reflectors.
Beam angles: 12°- 20°- 40° - 70°.

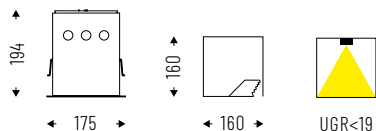

Cod. 4000K	Beam angle	lm	L mm
45VT118K412	1x18W 12°	2051	175x175
45VT118K420	1x18W 20°	2051	175x175
45VT118K440	1x18W 40°	2051	175x175
45VT118K470	1x18W 70°	2051	175x175
45VT125K412	1x25W 12°	2790	175x175
45VT125K420	1x25W 20°	2790	175x175
45VT125K440	1x25W 40°	2790	175x175
45VT125K470	1x25W 70°	2790	175x175
45VT134K412	1x34W 12°	4213	175x175
45VT134K420	1x34W 20°	4213	175x175
45VT134K440	1x34W 40°	4213	175x175
45VT134K470	1x34W 70°	4213	175x175
45VT138K412	1x38W 12°	4250	175x175
45VT138K420	1x38W 20°	4250	175x175
45VT138K440	1x38W 40°	4250	175x175
45VT138K470	1x38W 70°	4250	175x175

Cod. 3000K	Beam angle	lm	L mm
45VT118K312	1x18W 12°	1985	175x175
45VT118K320	1x18W 20°	1985	175x175
45VT118K340	1x18W 40°	1985	175x175
45VT118K370	1x18W 70°	1985	175x175
45VT125K312	1x25W 12°	2701	175x175
45VT125K320	1x25W 20°	2701	175x175
45VT125K340	1x25W 40°	2701	175x175
45VT125K370	1x25W 70°	2701	175x175
45VT134K312	1x34W 12°	4077	175x175
45VT134K320	1x34W 20°	4077	175x175
45VT134K340	1x34W 40°	4077	175x175
45VT134K370	1x34W 70°	4077	175x175
45VT138K312	1x38W 12°	4134	175x175
45VT138K320	1x38W 20°	4134	175x175
45VT138K340	1x38W 40°	4134	175x175
45VT138K370	1x38W 70°	4134	175x175

OTELLO LED 2X

IP 40

Internal aluminum reflectors.
Beam angles: 12°- 20°- 40° - 70°.

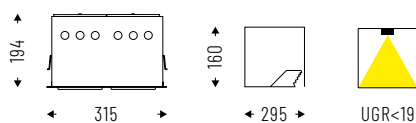

Cod. 4000K	Beam angle	lm	L mm
45VT218K412	2x18W 12°	4102	315x175
45VT218K420	2x18W 20°	4102	315x175
45VT218K440	2x18W 40°	4102	315x175
45VT218K470	2x18W 70°	4102	315x175
45VT225K412	2x25W 12°	5580	315x175
45VT225K420	2x25W 20°	5580	315x175
45VT225K440	2x25W 40°	5580	315x175
45VT225K470	2x25W 70°	5580	315x175
45VT234K412	2x34W 12°	8426	315x175
45VT234K420	2x34W 20°	8426	315x175
45VT234K440	2x34W 40°	8426	315x175
45VT234K470	2x34W 70°	8426	315x175
45VT238K412	2x38W 12°	8500	315x175
45VT238K420	2x38W 20°	8500	315x175
45VT238K440	2x38W 40°	8500	315x175
45VT238K470	2x38W 70°	8500	315x175

Cod. 3000K	Beam angle	lm	L mm
45VT218K312	2x18W 12°	3970	315x175
45VT218K320	2x18W 20°	3970	315x175
45VT218K340	2x18W 40°	3970	315x175
45VT218K370	2x18W 70°	3970	315x175
45VT225K312	2x25W 12°	5402	315x175
45VT225K320	2x25W 20°	5402	315x175
45VT225K340	2x25W 40°	5402	315x175
45VT225K370	2x25W 70°	5402	315x175
45VT234K312	2x34W 12°	8154	315x175
45VT234K320	2x34W 20°	8154	315x175
45VT234K340	2x34W 40°	8154	315x175
45VT234K370	2x34W 70°	8154	315x175
45VT238K312	2x38W 12°	8268	315x175
45VT238K320	2x38W 20°	8268	315x175
45VT238K340	2x38W 40°	8268	315x175
45VT238K370	2x38W 70°	8268	315x175

OTELLO LED ^{3X}

IP 40

Internal aluminum reflectors.
Beam angles: 12°- 20°- 40° - 70°.

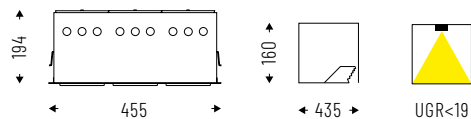

Cod. 4000K	Icon	lm	L mm
45VT318K412	3x18W 12°	6153	455x175
45VT318K420	3x18W 20°	6153	455x175
45VT318K440	3x18W 40°	6153	455x175
45VT318K470	3x18W 70°	6153	455x175
45VT325K412	3x25W 12°	8370	455x175
45VT325K420	3x25W 20°	8370	455x175
45VT325K440	3x25W 40°	8370	455x175
45VT325K470	3x25W 70°	8370	455x175
45VT334K412	3x34W 12°	12639	455x175
45VT334K420	3x34W 20°	12639	455x175
45VT334K440	3x34W 40°	12639	455x175
45VT334K470	3x34W 70°	12639	455x175
45VT338K412	3x38W 12°	12750	455x175
45VT338K420	3x38W 20°	12750	455x175
45VT338K440	3x38W 40°	12750	455x175
45VT338K470	3x38W 70°	12750	455x175

Cod. 3000K	Icon	lm	L mm
45VT318K312	3x18W 12°	5955	455x175
45VT318K320	3x18W 20°	5955	455x175
45VT318K340	3x18W 40°	5955	455x175
45VT318K370	3x18W 70°	5955	455x175
45VT325K312	3x25W 12°	8103	455x175
45VT325K320	3x25W 20°	8103	455x175
45VT325K340	3x25W 40°	8103	455x175
45VT325K370	3x25W 70°	8103	455x175
45VT334K312	3x34W 12°	12231	455x175
45VT334K320	3x34W 20°	12231	455x175
45VT334K340	3x34W 40°	12231	455x175
45VT334K370	3x34W 70°	12231	455x175
45VT338K312	3x38W 12°	12402	455x175
45VT338K320	3x38W 20°	12402	455x175
45VT338K340	3x38W 40°	12402	455x175
45VT338K370	3x38W 70°	12402	455x175

DOWNLIGHT

ACCESSORIES



Honeycomb optics.

45AAND



Micro-engraved optics.

45AASL



Frosted glass.

45AAMG

TECHNICAL NOTES



REMOVABLE AND ADJUSTABLE SPOTLIGHTS

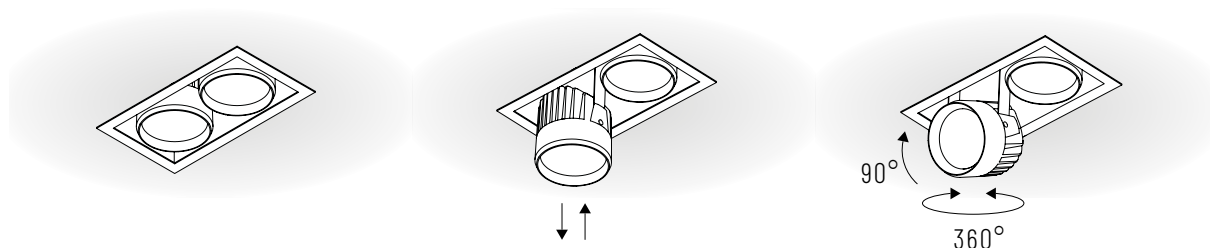

Thanks to 1, 2 or 3 light points and the possibility to extract and adjust the spotlights, **OTELLO LED** guarantees the maximum flexibility to direct the light.







NEXT

NEXT is the **contemporary design** fixture that perfectly fits in those architectural contexts where **sober and minimal shapes** are required. It is available as indoor versions for ceiling, recessed or recessed frameless installation, with **controlled UGR optics (<16)**. The wall version comes in single or double emission, with PG optics that guarantee a powerful and diffused emission. **NEXT** is also available in the IP66 outdoor ceiling version.







ID 50



FEATURES

-  Direct emission
-  Direct/Indirect emission
-  UGR <22; <16
-  IP 40; 66





LED

-  3000K/4000K
-  >107 lm/W
-  CRI >90
-  Eye safety: R60/R61
-  Mac Adams 3
-  L80/B10 >50.000h

CERTIFICATIONS

-  EEA Conformity
-  Energy efficiency
-  5 years warranty

ON REQUEST

-  DALI - code D
-  Bluetooth - code BT*
-  Emergency 1 hr - code EM*
Emergency 3 hrs - code EM3H*
-  2700K - code K27*

SPECIFICATIONS

Built-in driver.
SMD LED technology.
High Contrast UGR <16 diffuser.
Impact resistant satin acrylic diffuser with perimeter screen printing.
Aluminum frame with sealing gasket.
Homogeneous emission with UGR <22.

BODY

Die-cast aluminum with epoxy powder coating.

COLORS

White RAL 9003 wrinkled - code W
Black RAL 9005 wrinkled - code BK

RELATED PRODUCTS

Next IP66 (P. 169)
Next DK LV (P. 209)

* Where available

NEXT DK CEILING

Accessories on page 170.

IP 40

High Contrast dffuser UGR <16.

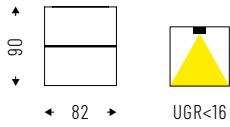

Cod. 4000K		lm	L mm
50DK16K4C	16W	1226	82x82

Cod. 3000K		lm	L mm
50DK16K3C	16W	1163	82x82

DOWNLIGHT

NEXT DK RECESSED

Accessories on page 170.

IP 40

High Contrast dffuser UGR <16.

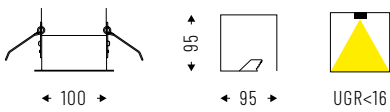

Cod. 4000K		lm	L mm
50DK16K4R	16W	1226	100x100

Cod. 3000K		lm	L mm
50DK16K3R	16W	1163	100x100

NEXT ^{DK} RECESSED FL

Accessories on page 170.

IP 40

High Contrast diffuser UGR <16.

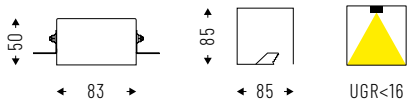

Cod. 4000K		lm	L mm
50DK16K4F	16W	1226	83x83

Cod. 3000K		lm	L mm
50DK16K3F	16W	1163	83x83

NEXT ^{WALL}

Accessories on page 170.

IP 40

Impact resistant satin-acrylic diffuser PG with perimeter screen printing, UGR <22.

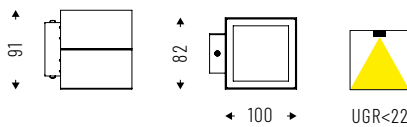

Cod. 4000K		lm	L mm
50PG10K4W	10W	652	82x100

Cod. 3000K		lm	L mm
50PG10K3W	10W	616	82x100

NEXT WALL DOUBLE EMISSION

Accessories on page 170.

IP 40

Impact resistant satin-acrylic diffuser PG with perimeter screen printing, UGR <22.

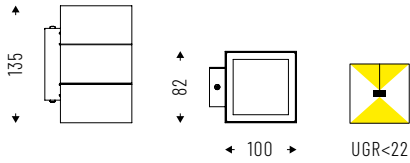

Cod. 4000K	Icon	lm	L mm
50DI20PGK4W	20W	1303	82x100

Cod. 3000K	Icon	lm	L mm
50DI20PGK3W	20W	1230	82x100

DOWNLIGHT

NEXT IP66 CEILING

Accessories on page 170.

IP 66

Impact resistant satin-acrylic diffuser PG with perimeter screen printing, UGR <22.

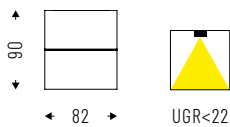

Cod. 4000K	Icon	lm	L mm
50PG10K4C66	10W	652	82x82

Cod. 3000K	Icon	lm	L mm
50PG10K3C66	10W	616	82x82

ACCESSORIES



5 poles-ceiling power cable for suspended applications (IP40 version). Cable length 2000mm.

50AA165P



TECHNICAL NOTES



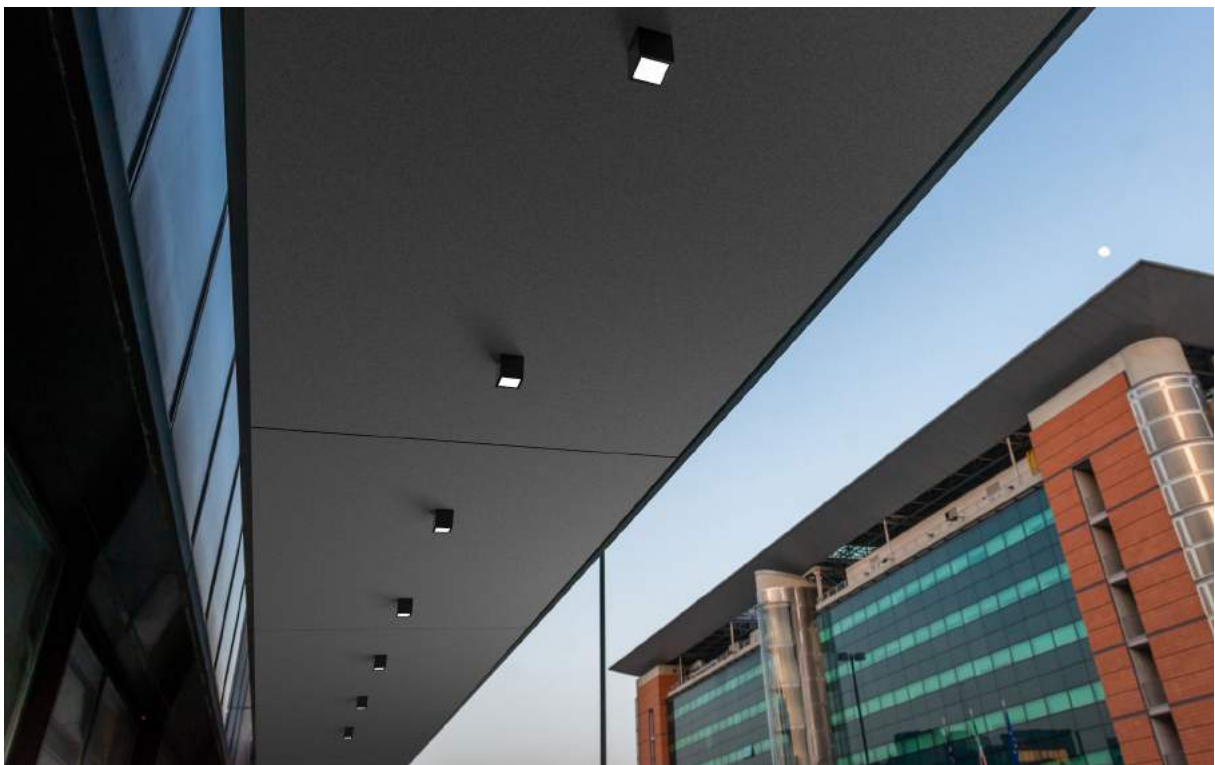





NEXT IP66 CEILING IS IDEAL FOR PORCHES AND LOGGIAS.



FEATURES

-  Direct emission
-  UGR <19
-  IP 44





LED

-  3000K/4000K
-  >135 lm/W
-  CRI >90
-  Eye safety: R60/R61
-  Mac Adams 3
-  L80/B10 >50.000h

CERTIFICATIONS

-  EEA Conformity
-  Energy efficiency
-  5 years warranty
-  ETL

ON REQUEST

-  DALI - code D*
-  Bluetooth - code BT*
-  2700K - code K27*
5000K - code K5*
-  Emergency 1 hr - code EM*
Emergency 3 hrs - code EM3H*

SPECIFICATIONS

Built-in driver.
CoB LED technology.
MINI: aluminum internal reflectors
- beam angles: 15°- 20°- 36°- 50°
SMALL: aluminum internal reflectors
- beam angles: 10°- 20°- 40°- 50°
MEDIUM / LARGE: aluminum internal
reflectors - beam angles:
10°- 12°- 20°- 40°- 70°

BODY

Die-cast aluminum with
epoxy powder coating.

COLORS

White RAL 9003 wrinkled
- code W
Black RAL 9005 wrinkled
- code BK

RELATED PRODUCTS

Hall Led Essential Ceiling (P. 175)
Hall Led IP65 (P. 292)
Hall Led Ceiling IP65 (P. 297)
Hall Led Ground (P. 300)

* Where available



DOWNLIGHT

HALL LED CEILING EVO is the downlight solution for ceiling application, available in **four sizes**: Mini, Small, Medium, Large and **different outputs**, in order to **satisfy all lighting requirements**. A further advantage is given by the degree of protection IP44 and the available range of optics. **Chip on Board technology and integrated driver** offer high efficiency and simple installation.

ID 28



HALL LED CEILING EVO ^{MINI}

Accessories on page 174.

IP 44

Internal aluminum reflectors.
Beam angles: 15° - 20° - 36° - 50°.
CUT OFF > 30°.

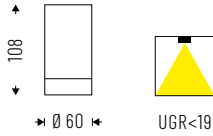

Cod. 4000K	☼	lm	Ø mm
28VT9K415	9W 15°	1071	60
28VT9K420	9W 20°	1071	60
28VT9K436	9W 36°	1071	60
28VT9K450	9W 50°	1071	60

Cod. 3000K	☼	lm	Ø mm
28VT9K315	9W 15°	904	60
28VT9K320	9W 20°	904	60
28VT9K336	9W 36°	904	60
28VT9K350	9W 50°	904	60

HALL LED CEILING EVO ^{SMALL}

Accessories on page 174.

IP 44

Internal aluminum reflectors.
Beam angles: 10° - 20° - 40° - 50°.
CUT OFF > 30°.

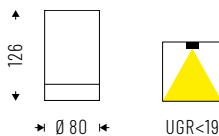

Cod. 4000K	☼	lm	Ø mm
28VT13K410SE	13W 10°	1152	80
28VT13K420SE	13W 20°	1152	80
28VT13K440SE	13W 40°	1152	80
28VT13K450SE	13W 50°	1152	80
28VT18K410SE	18W 10°	1595	80
28VT18K420SE	18W 20°	1595	80
28VT18K440SE	18W 40°	1595	80
28VT18K450SE	18W 50°	1595	80

Cod. 3000K	☼	lm	Ø mm
28VT13K310SE	13W 10°	1104	80
28VT13K320SE	13W 20°	1104	80
28VT13K340SE	13W 40°	1104	80
28VT13K350SE	13W 50°	1104	80
28VT18K310SE	18W 10°	1529	80
28VT18K320SE	18W 20°	1529	80
28VT18K340SE	18W 40°	1529	80
28VT18K350SE	18W 50°	1529	80

HALL LED CEILING EVO ^{MEDIUM}

Accessories on page 174.

IP 44

Internal aluminum reflectors.
Beam angles: 10°- 20°- 40°- 70°.
CUT OFF > 30°.

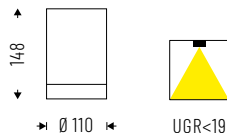

Cod. 4000K	☼	lm	Ø mm
28VT18K410ME	18W 10°	2316	110
28VT18K420ME	18W 20°	2316	110
28VT18K440ME	18W 40°	2316	110
28VT18K470ME	18W 70°	2316	110
28VT25K410ME	25W 10°	3151	110
28VT25K420ME	25W 20°	3151	110
28VT25K440ME	25W 40°	3151	110
28VT25K470ME	25W 70°	3151	110

Cod. 3000K	☼	lm	Ø mm
28VT18K310ME	18W 10°	2240	110
28VT18K320ME	18W 20°	2240	110
28VT18K340ME	18W 40°	2240	110
28VT18K370ME	18W 70°	2240	110
28VT25K310ME	25W 10°	3048	110
28VT25K320ME	25W 20°	3048	110
28VT25K340ME	25W 40°	3048	110
28VT25K370ME	25W 70°	3048	110

HALL LED CEILING EVO ^{LARGE}

Accessories on page 174.

IP 44

Internal aluminum reflectors.
Beam angles: 10°- 20°- 40°- 70°.
CUT OFF > 30°.

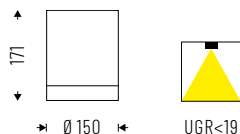

Cod. 4000K	☼	lm	Ø mm
28VT35K412LE	35W 12°	4029	150
28VT35K420LE	35W 20°	4029	150
28VT35K440LE	35W 40°	4029	150
28VT35K470LE	35W 70°	4029	150
28VT38K412LE	38W 12°	4214	150
28VT38K420LE	38W 20°	4214	150
28VT38K440LE	38W 40°	4214	150
28VT38K470LE	38W 70°	4214	150
28VT52K412LE	52W 12°	5647	150
28VT52K420LE	52W 20°	5647	150
28VT52K440LE	52W 40°	5647	150
28VT52K470LE	52W 70°	5647	150

Cod. 3000K	☼	lm	Ø mm
28VT35K312LE	35W 12°	3897	150
28VT35K320LE	35W 20°	3897	150
28VT35K340LE	35W 40°	3897	150
28VT35K370LE	35W 70°	3897	150
28VT38K312LE	38W 12°	4100	150
28VT38K320LE	38W 20°	4100	150
28VT38K340LE	38W 40°	4100	150
28VT38K370LE	38W 70°	4100	150
28VT52K312LE	52W 12°	5494	150
28VT52K320LE	52W 20°	5494	150
28VT52K340LE	52W 40°	5494	150
28VT52K370LE	52W 70°	5494	150

ACCESSORIES



Wire suspension kit with
3 pole-powered supply box.
Cable length: 3000mm.

28AA16SE - SMALL



Wire suspension kit with
3 pole-powered supply box.
Cable length: 3000mm.

28AA16ME - MEDIUM
28AA16LE - LARGE



Wire suspension kit with
5 pole-powered supply box.
Cable length: 3000mm.

28AA165PSE - SMALL
28AA165PME - MEDIUM
28AA165PLE - LARGE

ANTI-GLARE RINGS

Anti-glare rings that allow to focus the light beam hiding the light source. They perfectly fit in art galleries, museums and retail areas to value the subject with accent light without annoying glare issues.



28AA60AGW - MINI
Internal / external color:
White RAL 9003

28AA60AGWBK - MINI
Internal color: Black RAL 9005
External color: White RAL 9003

28AA60AGBK - MINI
Internal / external color:
Black RAL 9005



28AA80SAGW - SMALL
Internal / external color:
White RAL 9003

28AA80SAGWBK - SMALL
Internal color: Black RAL 9005
External color: White RAL 9003

28AA80SAGBK - SMALL
Internal / external color:
Black RAL 9005



28AAT10MAGW - MEDIUM
Internal / external color:
White RAL 9003.

28AAT10MAGWBK - MEDIUM
Internal color: Black RAL 9005
External color: White RAL 9003

28AAT10MAGBK - MEDIUM
Internal / external color:
Black RAL 9005

FEATURES

 Direct emission

 UGR <22

 IP 44

LED

 3000K/4000K

 >92 lm/W

 CRI >90

 Eye safety: R60/R61

 Mac Adams 3

 L80/B10 >50.000h

CERTIFICATIONS

 EEA Conformity

 Energy efficiency

 5 years warranty

ON REQUEST

 DALI - code D

 Bluetooth - code BT*

 Emergency 1 hr - code EM*
Emergency 3 hrs - code EM3H*

SPECIFICATIONS

Built-in driver.
SMD LED technology.
Opaline polycarbonate diffuser.

BODY

Polycarbonate, with die-cast
aluminum heat sink.

COLORS

Matte white RAL 9003 - code B
Matte black RAL 9005 - code C8



The cylindrical shape and the front cutoff give **HALL LED ESSENTIAL CEILING** a modern look and optimize the light distribution in a homogeneous way. Characterized by a **pure and essential shape**, it is ideal for residential and hospitality applications.

ID 28



* Where available

HALL LED ESSENTIAL CEILING

IP 44

Opaline polycarbonate diffuser.
Beam angles: 90 °. CUT OFF > 10 °.



Cod. 4000K	☼	lm	Ø mm
28PG15K4	15W	1380	204
28PG21K4	21W	1932	204

Cod. 3000K	☼	lm	Ø mm
28PG15K3	15W	1242	204
28PG21K3	21W	1739	204



TRACK SYSTEMS

TRACK SYSTEMS

Eurostandard Track	178	ID15
LV Track	184	ID15



C
H
A
P
T
E
R

F
I
V
E



EUROSTANDARD TRACK

EUROSTANDARD TRACK can be selected for either non-dimmable spotlights or applications needing **Bluetooth control**. The **EUROSTANDARD PLUS TRACK DALI** has an extra 2 conductors for use in **DALI applications** and is also offered in a **H-section version**, which can be used to add uplighting. All versions come in different lengths with mounting options which include direct, recessed, recessed trimless and suspended installation. The comprehensive range of compatible products and accessories complete this versatile product.

ID 15



SPECIFICATIONS

- The conductors are integrated in the track by means of rigid extruded profile made from insulating material guaranteeing high dielectric strength.
- The 3 separate circuits consisting of 3 phase conductors and a common neutral allow for 3 lighting configurations to be switched individually.
- The 3-phase supply allows for an overall loading of 16A (10500 VA) which can be divided among the 3 circuits (3x3500 VA)
- The earth, positioned on the side, leads to an asymmetrical structure of the track. As a consequence couplers must be selected carefully.

BODY

Aluminium

COLORS

White RAL 9003 - code B
Black RAL 9011 - code C8

COMPATIBLE PRODUCTS



QI (P. 200)



SEMPLICE LED (P. 44)



TERES (P. 88)



REM TRACK (P. 288)

EUROSTANDARD TRACK

Accessories on page 181.

IP 20

ON-OFF version

The cross section view shows the position of each line.

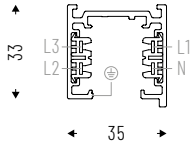

Cod.	Notes	L mm
15AA1	electrified track	1000
15AA2	electrified track	2000
15AA3	electrified track	3000

EUROSTANDARD PLUS TRACK DALI

Accessories on page 181.

IP 20

Dimmable version.

The cross section view shows the position of each line.

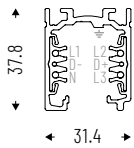

Cod.	Notes	L mm
15AA1DA	electrified track	1000
15AA2DA	electrified track	2000
15AA3DA	electrified track	3000

EUROSTANDARD PLUS TRACK DALI RECESSED

IP 20

Dimmable version for recessed installation.

The cross section view shows the position of each line.

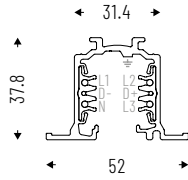

Cod.	Notes	L mm
15AA1DI	electrified track	1000
15AA2DI	electrified track	2000
15AA3DI	electrified track	3000

EUROSTANDARD PLUS TRACK DALI H

IP 20

Dimmable version. Possibility of using the upper part as cable passage, or as housing for indirect luminaires or emergency groups.

The cross section view shows the position of each line.

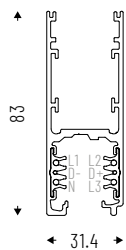

Cod.	Notes	L mm
15AA1DH	electrified track	1000
15AA2DH	electrified track	2000
15AA3DH	electrified track	3000

ACCESSORIES



ACCESSORIES FOR ON/OFF VERSION



Steel cable suspension kit.
Cable length 3000mm.

15AA1330



End-cap.

15AA09



Line end 250V-50Hz
max16A.

15AA09ELDX
15AA09ELSX



"L" coupler ON-OFF
250V-50Hz max 16A.

15AA05DX
15AA05SX



"T" coupler ON-OFF
250V-50Hz max 16A.

15AA06DX
15AA06SX



X coupler ON-OFF
250V-50Hz max 16A.

15AA07



Flexible coupler ON-OFF
250V-50Hz max 16A.

15AA12



Concealed straight
coupler ON-OFF
250V-50Hz max 16A.

15AA11

ACCESSORIES FOR DALI VERSION



5/ 7 pole ceiling
power cable.
Cable length 2000mm.

00AA165P
00AA167P



Steel cable suspension kit.
Cable length 1500mm.

15AA13D
15AA13DH - H version



Steel cable suspension kit.
Cable length 3000mm.

15AA1330D
15AA1330DH - H version



Ceiling mount.

15AA14D



Bracket for recessed
installation.

15AA17D



Additional IP40 cover strip.
Length 1000mm.

15AAGP1D



End-cap.

15AA09D



End-cap,
recessed version.

15AA09DI

ACCESSORIES



ACCESSORIES FOR DALI VERSION



End-cap, for H version.

15AA09DH



Live end 250V-50Hz
max16A.

15AA09ELDXD
15AA09ELSXD



Live end 250V-50Hz
max16A
for recessed version.

15AA09ELDXDI
15AA09ELSXDI



Live end 250V-50Hz
max16A
for H version.

15AA09ELDXDH
15AA09ELSXDH



"L" coupler
250V-50Hz max 16A
for DALI version.

15AA05DXD
15AA05SXD



"L" coupler
for recessed version.

15AA05DXDI
15AA05SXDI



"L" coupler
250V-50Hz max 16A
for H version.

15AA05DXDH
15AA05SXDH



"T" coupler (internal 08 /
external 06) 250V-50Hz
max 16A - for DALI version.

15AA06DXD
15AA06SXD
15AA08DXD
15AA08SXD

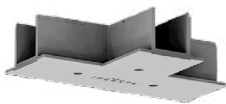

"T" coupler
(internal 08 / external 06)
for recessed version.

15AA06DXDI
15AA06SXDI
15AA08DXDI
15AA08SXDI

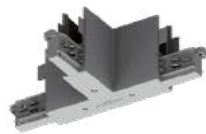

"T" coupler (internal 08 /
external 06) 250V-50Hz
max 16A - for H version.

15AA06DXDH
15AA06SXDH
15AA08DXDH
15AA08SXDH



"X" coupler
250V-50Hz max 16A
for DALI version.

15AA07D

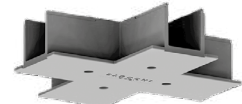

"X" coupler
for recessed version.

15AA07DI



"X" coupler
250V-50Hz max 16A
for H version.

15AA07DH



Concealed straight coupler
250V-50Hz max 16A.

15AA11D



Flexible coupler
250V-50Hz max 16A.

15AA12D



Cutting tool for track
conductors.

15AATC

TECHNICAL NOTES



LOAD CAPACITY AND ELECTRICAL DIAGRAMS

LOAD CAPACITY

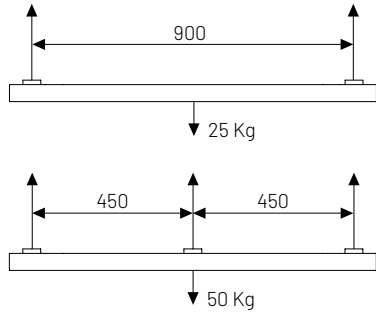

ELECTRICAL DIAGRAMS

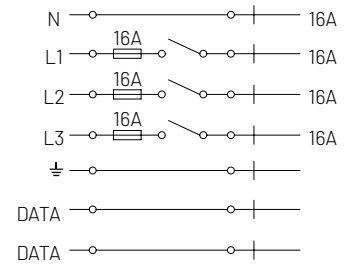
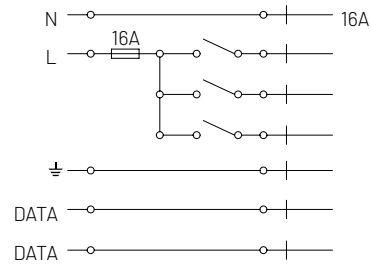

EXAMPLE OF INSTALLATION DIAGRAM WITH ITEM CODES

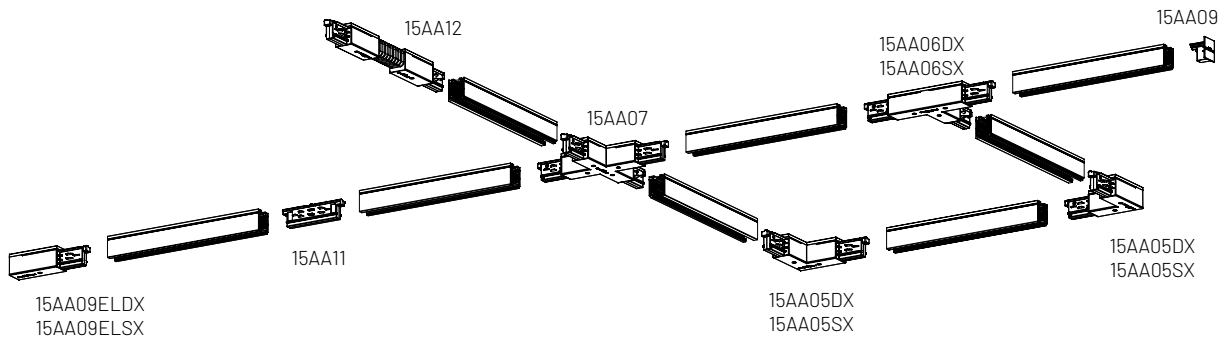

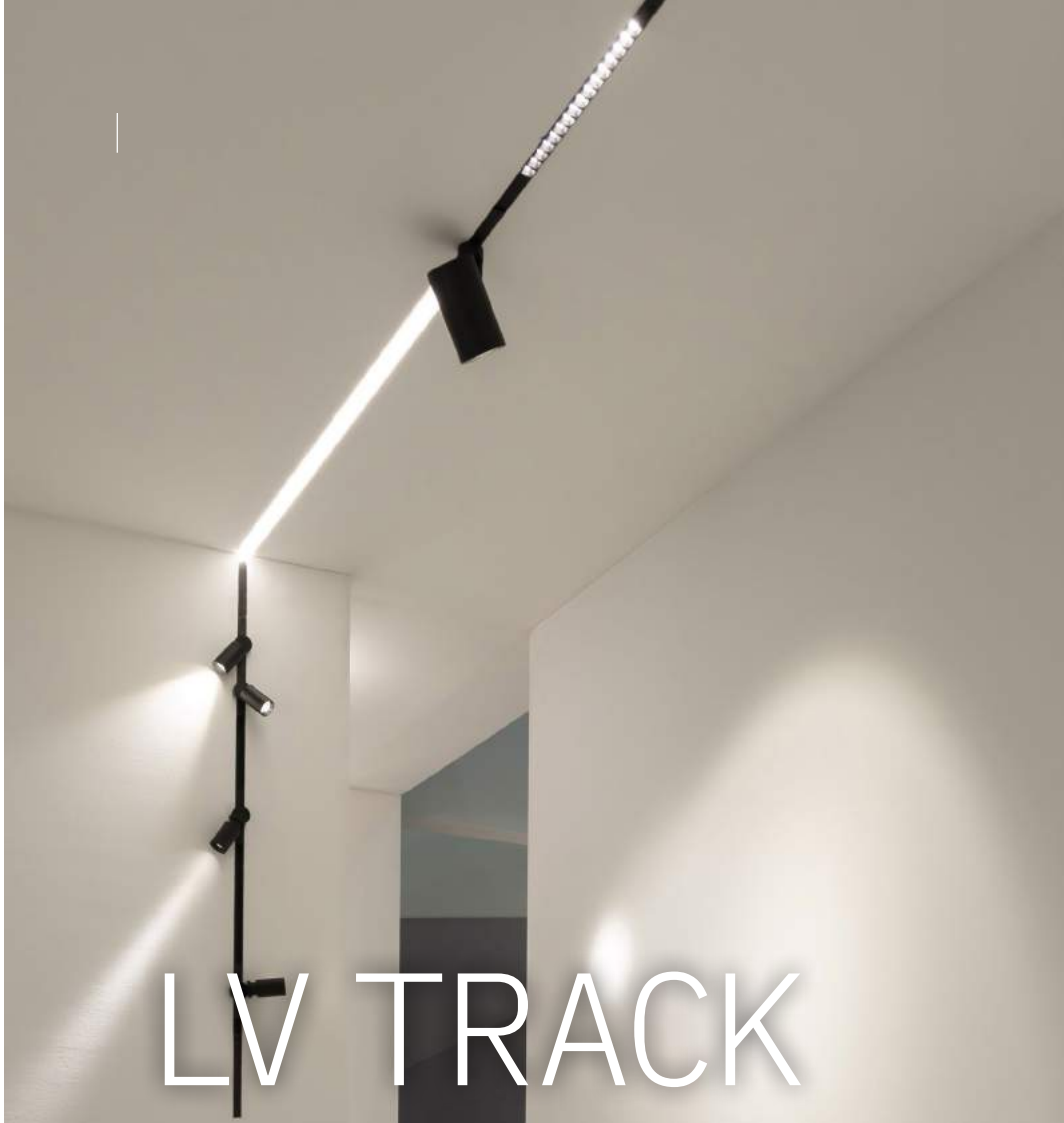

LV TRACK

LVTRACK is suitable for all Esse-Ci **48V LV lighting fixtures**. The track is available in three versions for surface, recessed and suspended applications. Each track boasts **minimal dimensions** for an absolutely discrete installation effect. A wide range of accessories complements each track style. Being SELV, **rapid and safe coupling of luminaires** is possible. Esse-Ci **LV TRACK** promotes optimum **flexibility and minimalism** without compromising performance.

ID 15

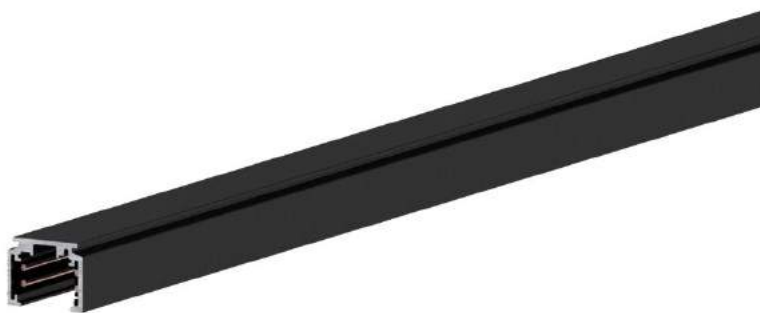

SPECIFICATIONS

Low voltage tracks (up to 60V dc)
Circuits: 2 x 15A + Databus circuit.

BODY

Aluminium

COLORS

White RAL 9003 - code B
Black RAL 9011 - code C8

ON REQUEST

Recessed frameless version.

COMPATIBLE PRODUCTS



NEXT DK LV (P. 209)



LUDO (P. 217)



TERES LV (P. 215)



TERES MICRO ZOOM (P. 213)



JOOLS (P. 223)



STYLO LV (P. 225)



LUDO LINEAR 2.0 (P. 219)



LUDO LINEAR DK (P. 221)



BEN LV (P. 211)

LV TRACK

Accessories on page 186.

IP 20

Ceiling version.

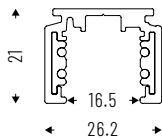

Cod.	Notes	L mm
15LV1M	Electrified LV Track	1000
15LV2M	Electrified LV Track	2000
15LV3M	Electrified LV Track	3000

LV TRACK RECESSED

Accessories on page 186.

IP 20

Recessed version.

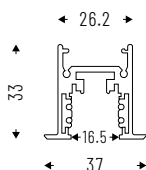

Cod.	Notes	L mm
15LV1RM	Electrified LV Track	1000
15LV2RM	Electrified LV Track	2000
15LV3RM	Electrified LV Track	3000

ACCESSORIES



End caps kit for
LV TRACK.

15LV09M



End caps kit for
LV TRACK RECESSED.

15LV09RM



Single wire adjustable
suspension kit for LV TRACK.

15LV13 1500mm
15LV1330 3000mm



Spring clips for
LV TRACK RECESSED.

15LV17RM



Electrified end feed.

15LV09EL



Electrified flexible joint.

15LV12



Electrified linear joint.

15LV11EL



Electrified 90° joint.

15LV05EL



48V 75W and 150W driver
for remote installation.

15LV7548IS
15LV15048IS





Cutting tool for track
conductors.

15AATC



SPOTLIGHT

Teres	188	ID14	
Teres Exte	195	ID14	
Qi	200	ID19	

SPOTLIGHT

C
H
A
P
T
E
R

S
I
X





TERES

TERES is the sophisticated and professional track spot that, thanks to the **built-in driver, compact design and advanced technology**, has managed to hit the spot in the retail world, **adapting completely to any environment** without being invasive. Its technical vocation is also suitable for areas that need more decisive lighting thanks to the High Flux version, with efficiencies up to 110lm / W. The Wall Washer version with asymmetrical beam and the **new HF FOOD version**, dedicated to the best color rendering of food, complete a range that has now become the reference point in the world of spotlights.







ID 14



FEATURES

-  Direct emission
-  UGR <19
-  IP40



LED

-  3000K/4000K
-  >110 lm/W
-  CRI >90
-  Eye safety: R60/R61
-  Mac Adams 3
-  L80/B10 >50.000h

CERTIFICATIONS

-  EEA Conformity
-  Energy efficiency
-  5 years warranty
-  ETL Certification

ON REQUEST

-  DALI - code D*
-  Bluetooth - code BT*
-  2700K - code: K27*
5000K - code: K5*

SPECIFICATIONS

Built-in driver.
CoB LED technology.
Internal aluminum reflectors, beam angles: 10°- 15°- 20°- 36°- 40°- 50°- 70°.
ZOOM: internal aluminum reflector with adjustable emission from 25° to 60°.
Polycarbonate lens.
Asymmetrical beam for Wall Washer.

BODY

Die-cast aluminum with epoxy powder coating.

COLORS

White RAL 9003 wrinkled - code W
Black RAL 9005 wrinkled - code BK

RELATED PRODUCTS

Teres Exte (P. 195)
Teres Micro Zoom (P. 213)
Teres LV (P. 215)
Teres IP66 (P. 309)

*Verificata disponibilita

TERES ^{MINI}

Accessories on page 194.

IP 40

Internal aluminum reflectors.
Beam angles: 15° - 20° - 36° - 50°.

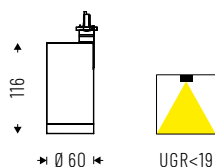

Cod. 4000K	☼	lm	Ø mm
14VT9K415	9W 15°	1094	60
14VT9K420	9W 20°	1094	60
14VT9K436	9W 36°	1094	60
14VT9K450	9W 50°	1094	60

Cod. 3000K	☼	lm	Ø mm
14VT9K315	9W 15°	923	60
14VT9K320	9W 20°	923	60
14VT9K336	9W 36°	923	60
14VT9K350	9W 50°	923	60

TERES ^{SMALL}

Accessories on page 194.

IP 40

Internal aluminum reflectors.
Beam angles: 10° - 20° - 40° - 50°.

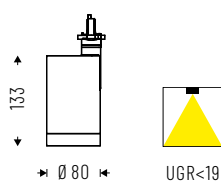

Cod. 4000K	☼	lm	Ø mm
14VT13K410S	13W 10°	1467	80
14VT13K420S	13W 20°	1467	80
14VT13K440S	13W 40°	1467	80
14VT13K450S	13W 50°	1467	80
14VT18K410S	18W 10°	1991	80
14VT18K420S	18W 20°	1991	80
14VT18K440S	18W 40°	1991	80
14VT18K450S	18W 50°	1991	80

Cod. 3000K	☼	lm	Ø mm
14VT13K310S	13W 10°	1335	80
14VT13K320S	13W 20°	1335	80
14VT13K340S	13W 40°	1335	80
14VT13K350S	13W 50°	1335	80
14VT18K310S	18W 10°	1812	80
14VT18K320S	18W 20°	1812	80
14VT18K340S	18W 40°	1812	80
14VT18K350S	18W 50°	1812	80

TERES MEDIUM

Accessories on page 194.

IP 40

Internal aluminum reflectors.
Beam angles: 10° - 20° - 40° - 70°.

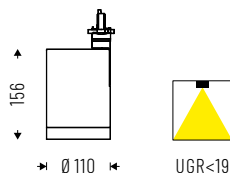

Cod. 4000K	☼	lm	Ø mm
14VT18K410M	18W 10°	2086	110
14VT18K420M	18W 20°	2086	110
14VT18K440M	18W 40°	2086	110
14VT18K470M	18W 70°	2086	110
14VT25K410M	25W 10°	2874	110
14VT25K420M	25W 20°	2874	110
14VT25K440M	25W 40°	2874	110
14VT25K470M	25W 70°	2874	110
14VT33K410M	33W 10°	3683	110
14VT33K420M	33W 20°	3683	110
14VT33K440M	33W 40°	3683	110
14VT33K470M	33W 70°	3683	110

Cod. 3000K	☼	lm	Ø mm
14VT18K310M	18W 10°	1898	110
14VT18K320M	18W 20°	1898	110
14VT18K340M	18W 40°	1898	110
14VT18K370M	18W 70°	1898	110
14VT25K310M	25W 10°	2615	110
14VT25K320M	25W 20°	2615	110
14VT25K340M	25W 40°	2615	110
14VT25K370M	25W 70°	2615	110
14VT33K310M	33W 10°	3566	110
14VT33K320M	33W 20°	3566	110
14VT33K340M	33W 40°	3566	110
14VT33K370M	33W 70°	3566	110

TERES HF

Accessories on page 194.

IP 40

Internal aluminum reflectors.
Beam angles: 10° - 20° - 40° - 70°.

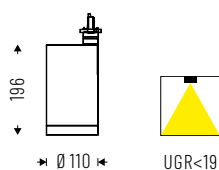

Cod. 4000K	☼	lm	Ø mm
14VT36K410HF	36W 10°	4091	110
14VT36K420HF	36W 20°	4091	110
14VT36K440HF	36W 40°	4091	110
14VT36K470HF	36W 70°	4091	110
14VT42K410HF	42W 10°	4873	110
14VT42K420HF	42W 20°	4873	110
14VT42K440HF	42W 40°	4873	110
14VT42K470HF	42W 70°	4873	110
14VT50K410HF	50W 10°	5243	110
14VT50K420HF	50W 20°	5243	110
14VT50K440HF	50W 40°	5243	110
14VT50K470HF	50W 70°	5243	110

Cod. 3000K	☼	lm	Ø mm
14VT36K310HF	36W 10°	3719	110
14VT36K320HF	36W 20°	3719	110
14VT36K340HF	36W 40°	3719	110
14VT36K370HF	36W 70°	3719	110
14VT42K310HF	42W 10°	4440	110
14VT42K320HF	42W 20°	4440	110
14VT42K340HF	42W 40°	4440	110
14VT42K370HF	42W 70°	4440	110
14VT50K310HF	50W 10°	4774	110
14VT50K320HF	50W 20°	4774	110
14VT50K340HF	50W 40°	4774	110
14VT50K370HF	50W 70°	4774	110

TERES ZOOM SMALL

Accessories on page 194.

IP 40

Polycarbonate lens.

Adjustable beam angles from 25° to 60°.

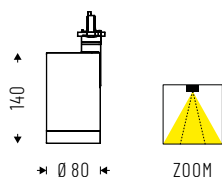

Cod. 4000K	☼	lm	Ø mm
14ZM13K4S	13W	1634	80

Cod. 3000K	☼	lm	Ø mm
14ZM13K3S	13W	1485	80

TERES ZOOM MEDIUM

Accessories on page 194.

IP 40

Polycarbonate lens.

Adjustable beam angles from 25° to 60°.

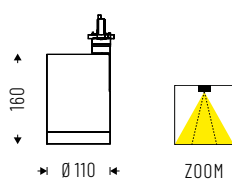

Cod. 4000K	☼	lm	Ø mm
14ZM18K4M	18W	2182	110
14ZM25K4M	25W	3031	110
14ZM33K4M	33W	3380	110

Cod. 3000K	☼	lm	Ø mm
14ZM18K3M	18W	2040	110
14ZM25K3M	25W	2833	110
14ZM33K3M	33W	3130	110

TERES ^{WW SMALL}

Accessories on page 194.

IP 40

Polycarbonate lens for Wall Washer emission.

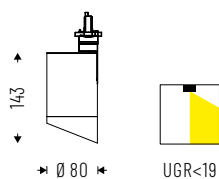

Cod. 4000K		lm	Ø mm
14WW13K4S	13W	1339	80
14WW18K4S	18W	1871	80

Cod. 3000K		lm	Ø mm
14WW13K3S	13W	1289	80
14WW18K3S	18W	1782	80

TERES ^{WW MEDIUM}

Accessories on page 194.

IP 40

Polycarbonate lens for Wall Washer emission.

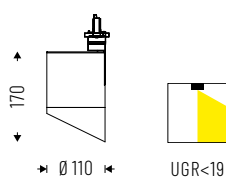

Cod. 4000K		lm	Ø mm
14WW18K4M	18W	1887	110
14WW25K4M	25W	2619	110
14WW33K4M	33W	3391	110

Cod. 3000K		lm	Ø mm
14WW18K3M	18W	1797	110
14WW25K3M	25W	2495	110
14WW33K3M	33W	3293	110

TERES HF FOOD

Accessories on page 194.

IP 40

Internal aluminum reflectors.
Beam angles: 10° - 20° - 40° - 70°.

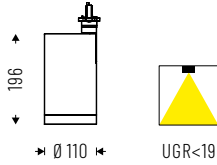

Cod. BREAD	Icon	lm	Ø mm
14VT38BR10HF	38W 10° BREAD	2366	110
14VT38BR20HF	38W 20° BREAD	2366	110
14VT38BR40HF	38W 40° BREAD	2366	110
14VT38BR70HF	38W 70° BREAD	2366	110
14VT54BR10HF	54W 10° BREAD	3537	110
14VT54BR20HF	54W 20° BREAD	3537	110
14VT54BR40HF	54W 40° BREAD	3537	110
14VT54BR70HF	54W 70° BREAD	3537	110

Cod. MEAT	Icon	lm	Ø mm
14VT38MT10HF	38W 10° MEAT	1788	110
14VT38MT20HF	38W 20° MEAT	1788	110
14VT38MT40HF	38W 40° MEAT	1788	110
14VT38MT70HF	38W 70° MEAT	1788	110
14VT54MT10HF	54W 10° MEAT	2516	110
14VT54MT20HF	54W 20° MEAT	2516	110
14VT54MT40HF	54W 40° MEAT	2516	110
14VT54MT70HF	54W 70° MEAT	2516	110

Cod. FISH	Icon	lm	Ø mm
14VT38FH10HF	38W 10° FISH	2628	110
14VT38FH20HF	38W 20° FISH	2628	110
14VT38FH40HF	38W 40° FISH	2628	110
14VT38FH70HF	38W 70° FISH	2628	110

Cod. FISH	Icon	lm	Ø mm
14VT54FH10HF	54W 10° FISH	3857	110
14VT54FH20HF	54W 20° FISH	3857	110
14VT54FH40HF	54W 40° FISH	3857	110
14VT54FH70HF	54W 70° FISH	3857	110

SPOTLIGHT

SPECIALIZED LED MODULES - FOOD



Premium CRI >90 luminaires with 3000K and 4000K color temperatures that **enhance the color of natural products** and are therefore suitable for the lighting of fruits, vegetables and food departments:

- **BREAD:** brown shades appear sharper and brighter, with golden reflexes. Cheeses and other ingredients used in baked goods such as pizza and sandwiches get enhanced in their colors.
- **MEAT / FRESH MEAT:** red tones are extraordinarily stronger, for a fresh and inviting presentation of red and cured meats.
- **FISH:** colors are lively and attractive, the fish looks bright and colorful; the cold shades of light enhance the freshness and brilliance of the fish.

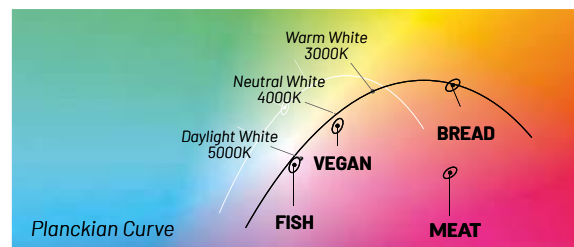

ACCESSORIES



TERES OPTICS



TERES SMALL
clear glass.

14AAVTS



TERES SMALL
frost glass.

14AAM6S



TERES SMALL
micro-engraved glass.

14AASLS



TERES SMALL
honeycomb optics.

14AANDS



TERES MEDIUM
clear glass.

14AAVTM



TERES MEDIUM
frost glass.

14AAM6M



TERES MEDIUM
micro-engraved glass.

14AASLM



TERES MEDIUM
honeycomb optics.

14AANDM

ANTI-GLARE RINGS

Anti-glare rings that allow to focus the light beam hiding the light source. They perfectly fit in art galleries, museums and retail areas to value the subject with accent light without annoying glare issues - UGR<16.



14AA60AGW - TERES MINI
Internal / external color:
White RAL 9003

14AA60AGWBK - TERES MINI
Internal color: Black RAL 9005
External color: White RAL 9003

14AA60AGBK - TERES MINI
Internal / external color:
Black RAL 9005



14AA80AGW - TERES SMALL
Internal / external color:
White RAL 9003

14AA80AGWBK - TERES SMALL
Internal color: Black RAL 9005
External color: White RAL 9003

14AA80AGBK - TERES SMALL
Internal / external color:
Black RAL 9005





14AA110AGW - TERES MEDIUM E HF
Internal / external color:
White RAL 9003.







14AA110AGWBK - TERES MEDIUM E HF
Internal color: Black RAL 9005
External color: White RAL 9003

14AA110AGBK - TERES MEDIUM E HF
Internal / external color:
Black RAL 9005

FEATURES

-  Direct emission
-  UGR <19
-  IP40



LED

-  3000K/4000K
-  >110 lm/W; >113 lm/W
-  CRI >110
-  Eye safety: R60/R61
-  Mac Adams 3
-  L80/B10 >50.000h

CERTIFICATIONS

-  EEA Conformity
-  Energy efficiency
-  5 years warranty
-  ETL certification

ON REQUEST

-  DALI - code D
-  Bluetooth - code BT*
-  2700K - code: K27*
5000K - code: K5*

SPECIFICATIONS

Built-in driver.
CoB LED technology.
Internal aluminum reflectors:
beam angles: 10°- 20°- 40°- 50°- 70°

BODY

Die-cast aluminum
with epoxy powder coating

COLORS

White RAL 9003 wrinkled
- code W
Black RAL 9005 wrinkled
- code BK

RELATED PRODUCTS

Teres (P. 188)
Teres Micro Zoom (P. 213)
Teres LV (P. 215)
Teres IP66 (P. 309)



SPOTLIGHT

Differentiation is a factor of success: versatility is an important aspect in the world of lighting. This is how **TERES EXTE** was born from the TERES family, allowing the luminaire to be applied as a stand alone fixture, for both surface or recessed installation. With the **driver integrated inside the body, it fits to any situation** thanks to the minimal design and purity of shapes. The **TERES EXTE COVE** version can also be installed as a free-standing luminaire on cornices or perimeter coves.

ID 14



*Verificata dinoninabilita

arlico

www.arlico.co.uk » +44 (0) 23 8202 2100 » refer to our website for the complete product range

TERES EXTE CEILING SMALL

Accessories on page 199.

IP 40

Internal aluminum reflectors.
Beam angles: 10° - 20° - 40° - 50°.

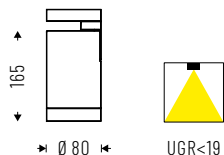

Cod. 4000K	Beam angle	lm	Ø mm
14VT13K410SP	13W 10°	1467	80
14VT13K420SP	13W 20°	1467	80
14VT13K440SP	13W 40°	1467	80
14VT13K450SP	13W 50°	1467	80
14VT18K410SP	18W 10°	1991	80
14VT18K420SP	18W 20°	1991	80
14VT18K440SP	18W 40°	1991	80
14VT18K450SP	18W 50°	1991	80

Cod. 3000K	Beam angle	lm	Ø mm
14VT13K310SP	13W 10°	1335	80
14VT13K320SP	13W 20°	1335	80
14VT13K340SP	13W 40°	1335	80
14VT13K350SP	13W 50°	1335	80
14VT18K310SP	18W 10°	1812	80
14VT18K320SP	18W 20°	1812	80
14VT18K340SP	18W 40°	1812	80
14VT18K350SP	18W 50°	1812	80

TERES EXTE CEILING MEDIUM

Accessories on page 199.

IP 40

Internal aluminum reflectors.
Beam angles: 10° - 20° - 40° - 70°.

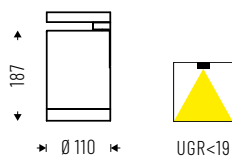

Cod. 4000K	Beam angle	lm	Ø mm
14VT18K410MP	18W 10°	2086	110
14VT18K420MP	18W 20°	2086	110
14VT18K440MP	18W 40°	2086	110
14VT18K470MP	18W 70°	2086	110
14VT25K410MP	25W 10°	2874	110
14VT25K420MP	25W 20°	2874	110
14VT25K440MP	25W 40°	2874	110
14VT25K470MP	25W 70°	2874	110
14VT33K410MP	33W 10°	3683	110
14VT33K420MP	33W 20°	3683	110
14VT33K440MP	33W 40°	3683	110
14VT33K470MP	33W 70°	3683	110

Cod. 3000K	Beam angle	lm	Ø mm
14VT18K310MP	18W 10°	1898	110
14VT18K320MP	18W 20°	1898	110
14VT18K340MP	18W 40°	1898	110
14VT18K370MP	18W 70°	1898	110
14VT25K310MP	25W 10°	2615	110
14VT25K320MP	25W 20°	2615	110
14VT25K340MP	25W 40°	2615	110
14VT25K370MP	25W 70°	2615	110
14VT33K310MP	33W 10°	3566	110
14VT33K320MP	33W 20°	3566	110
14VT33K340MP	33W 40°	3566	110
14VT33K370MP	33W 70°	3566	110

TERES EXTE RECESSED SMALL

Accessories on page 199.

IP 40

Internal aluminum reflectors.
Beam angles: 10° - 20° - 40° - 50°.

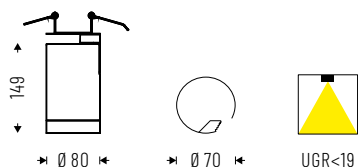

Cod. 4000K	Beam angle	lm	Ø mm
14VT13K410SR	13W 10°	1467	80
14VT13K420SR	13W 20°	1467	80
14VT13K440SR	13W 40°	1467	80
14VT13K450SR	13W 50°	1467	80
14VT18K410SR	18W 10°	1991	80
14VT18K420SR	18W 20°	1991	80
14VT18K440SR	18W 40°	1991	80
14VT18K450SR	18W 50°	1991	80

Cod. 3000K	Beam angle	lm	Ø mm
14VT13K310SR	13W 10°	1335	80
14VT13K320SR	13W 20°	1335	80
14VT13K340SR	13W 40°	1335	80
14VT13K350SR	13W 50°	1335	80
14VT18K310SR	18W 10°	1812	80
14VT18K320SR	18W 20°	1812	80
14VT18K340SR	18W 40°	1812	80
14VT18K350SR	18W 50°	1812	80

TERES EXTE RECESSED MEDIUM

Accessories on page 199.

IP 40

Internal aluminum reflectors.
Beam angles: 10° - 20° - 40° - 70°.

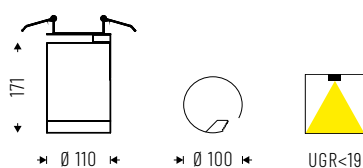

Cod. 4000K	Beam angle	lm	Ø mm
14VT18K410MR	18W 10°	2086	110
14VT18K420MR	18W 20°	2086	110
14VT18K440MR	18W 40°	2086	110
14VT18K470MR	18W 70°	2086	110
14VT25K410MR	25W 10°	2874	110
14VT25K420MR	25W 20°	2874	110
14VT25K440MR	25W 40°	2874	110
14VT25K470MR	25W 70°	2874	110
14VT33K410MR	33W 10°	3683	110
14VT33K420MR	33W 20°	3683	110
14VT33K440MR	33W 40°	3683	110
14VT33K470MR	33W 70°	3683	110

Cod. 3000K	Beam angle	lm	Ø mm
14VT18K310MR	18W 10°	1898	110
14VT18K320MR	18W 20°	1898	110
14VT18K340MR	18W 40°	1898	110
14VT18K370MR	18W 70°	1898	110
14VT25K310MR	25W 10°	2615	110
14VT25K320MR	25W 20°	2615	110
14VT25K340MR	25W 40°	2615	110
14VT25K370MR	25W 70°	2615	110
14VT33K310MR	33W 10°	3566	110
14VT33K320MR	33W 20°	3566	110
14VT33K340MR	33W 40°	3566	110
14VT33K370MR	33W 70°	3566	110

TERES EXTE COVE HF

IP 40

Internal aluminum reflectors.
Beam angles: 10° - 20° - 40° - 70°.

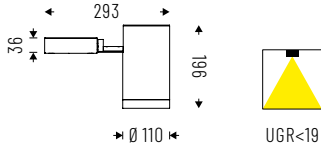

Cod. 4000K	☼	lm	Ø mm
14VT36K410HFC	36W 10°	4091	110
14VT36K420HFC	36W 20°	4091	110
14VT36K440HFC	36W 40°	4091	110
14VT36K470HFC	36W 70°	4091	110
14VT42K410HFC	42W 10°	4873	110
14VT42K420HFC	42W 20°	4873	110
14VT42K440HFC	42W 40°	4873	110
14VT42K470HFC	42W 70°	4873	110
14VT50K410HFC	50W 10°	5243	110
14VT50K420HFC	50W 20°	5243	110
14VT50K440HFC	50W 40°	5243	110
14VT50K470HFC	50W 70°	5243	110

Cod. 3000K	☼	lm	Ø mm
14VT36K310HFC	36W 10°	3719	110
14VT36K320HFC	36W 20°	3719	110
14VT36K340HFC	36W 40°	3719	110
14VT36K370HFC	36W 70°	3719	110
14VT42K310HFC	42W 10°	4440	110
14VT42K320HFC	42W 20°	4440	110
14VT42K340HFC	42W 40°	4440	110
14VT42K370HFC	42W 70°	4440	110
14VT50K310HFC	50W 10°	4774	110
14VT50K320HFC	50W 20°	4774	110
14VT50K340HFC	50W 40°	4774	110
14VT50K370HFC	50W 70°	4774	110

ACCESSORIES



TERES EXTE OPTICS (ONLY FOR CEILING AND RECESSED VERSIONS)



TERES EXTE SMALL
clear glass.

14AAVTS



TERES EXTE SMALL
frost glass.

14AAM6S



TERES EXTE SMALL
micro-engraved glass.

14AASLS



TERES EXTE SMALL
honeycomb optics.

14AANDS



TERES EXTE MEDIUM
clear glass.

14AAVTM



TERES EXTE MEDIUM
frost glass.

14AAM6M



TERES EXTE MEDIUM
micro-engraved glass.

14AASLM



TERES EXTE MEDIUM
honeycomb optics.

14AANDM

ANTI-GLARE RINGS

Anti-glare rings that allow to focus the light beam hiding the light source. They perfectly fit in art galleries, museums and retail areas to value the subject with accent light without annoying glare issues - UGR<16.



14AA80AGW - TERES SMALL
Internal / external color:
White RAL 9003

14AA80AGWBK - TERES SMALL
Internal color: Black RAL 9005
External color: White RAL 9003

14AA80AGBK - TERES SMALL
Internal / external color:
Black RAL 9005



14AA110AGW - TERES MEDIUM / HF
Internal / external color:
White RAL 9003

14AA110AGWBK - TERES MEDIUM / HF
Internal color: Black RAL 9005
External color: White RAL 9003

14AA110AGBK - TERES MEDIUM / HF
Internal / external color:
Black RAL 9005



QI



QI is an exciting lighting concept set to **revolutionize** the way designers consider **traditional 3-circuit lighting track applications**. Perfect for retrofit or new designs, **QI fits seamlessly within regular EU tracks**. The types of applications are only restricted by the designers imagination, its wide range of power and outputs, integrated driver, choice of beam angles including asymmetric light distribution, make **QI** perfect for retail, museum, educational and commercial projects, just to name but a few.

ID 19









Design
Quargnale

FEATURES

-  Direct emission
-  UGR < 22
-  IP40

LED

-  3000K/4000K
-  >90 lm/W; >105 lm/W
-  CRI > 90
-  Eye safety: R60/R61
-  Mac Adams 3
-  L80/B10 > 50.000h

CERTIFICATIONS

-  EEA Conformity
-  Energy efficiency
-  5 years warranty

ON REQUEST

-  DALI - code D*

SPECIFICATIONS

Built-in driver.
Satin methacrylate diffuser for wide beam emission.
Polycarbonate lens for asymmetrical emission.

BODY

Aluminum with polycarbonate electric adapter.
Compatible with EU Track rails.

RELATED PRODUCTS

Eurostandard Track (P. 200)

*Verificare disponibilità

QI PG LOW POWER

IP 40

Methacrylate satin antistatic diffuser screen, UGR<22.
ILC (Indirect Light Control) technology for partially indirect emission.

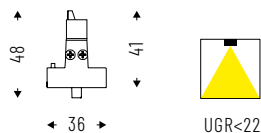

Cod. 4000K	Icon	lm	L mm
19PG12K4	12W	1185	650
19PG18K4	18W	1777	930
19PG24K4	24W	2368	1210
19PG30K4	30W	2961	1490
19PG36K4	36W	3553	1770
19PG48K4	48W	4739	2330

Cod. 3000K	Icon	lm	L mm
19PG12K3	12W	1135	650
19PG18K3	18W	1703	930
19PG24K3	24W	2270	1210
19PG30K3	30W	2838	1490
19PG36K3	36W	3406	1770
19PG48K3	48W	4541	2330

QI PG HIGH POWER

IP 40

Methacrylate satin antistatic diffuser screen, UGR<22.
ILC (Indirect Light Control) technology for partially indirect emission.

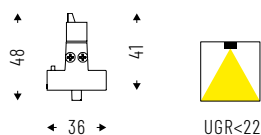

Cod. 4000K	Icon	lm	L mm
19PG24K4HP	24W	2457	650
19PG36K4HP	36W	3686	930
19PG48K4HP	48W	4915	1210
19PG60K4HP	60W	6144	1490
19PG72K4HP	72W	7372	1770
19PG96K4HP	96W	9830	2330

Cod. 3000K	Icon	lm	L mm
19PG24K3HP	24W	2376	650
19PG36K3HP	36W	3564	930
19PG48K3HP	48W	4752	1210
19PG60K3HP	60W	5940	1490
19PG72K3HP	72W	7128	1770
19PG96K3HP	96W	9504	2330

QI AS-DX LOW POWER

IP 40

Polycarbonate lens for asymmetrical beam.
Maximum installation height: 3 meters.

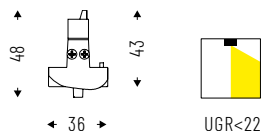

Cod. 4000K	Icon	lm	L mm
19AS12K4DX	12W	1487	650
19AS18K4DX	18W	2232	930
19AS24K4DX	24W	2976	1210
19AS30K4DX	30W	3719	1490
19AS36K4DX	36W	4463	1770
19AS48K4DX	48W	5950	2330

Cod. 3000K	Icon	lm	L mm
19AS12K3DX	12W	1439	650
19AS18K3DX	18W	2158	930
19AS24K3DX	24W	2878	1210
19AS30K3DX	30W	3597	1490
19AS36K3DX	36W	4316	1770
19AS48K3DX	48W	5755	2330

QI AS-DX HIGH POWER

IP 40

Polycarbonate lens for asymmetrical beam.
Maximum installation height: 3 meters.

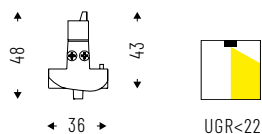

Cod. 4000K	Icon	lm	L mm
19AS24K4HPDX	24W	2976	650
19AS36K4HPDX	36W	4463	930
19AS48K4HPDX	48W	5951	1210
19AS60K4HPDX	60W	7438	1490
19AS72K4HPDX	72W	8925	1770
19AS96K4HPDX	96W	11900	2330

Cod. 3000K	Icon	lm	L mm
19AS24K3HPDX	24W	2878	650
19AS36K3HPDX	36W	4316	930
19AS48K3HPDX	48W	5755	1210
19AS60K3HPDX	60W	7194	1490
19AS72K3HPDX	72W	8633	1770
19AS96K3HPDX	96W	11510	2330

QI AS-SX LOW POWER

IP 40

Polycarbonate lens for asymmetrical beam.
Maximum installation height: 3 meters.

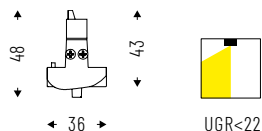

Cod. 4000K	Icon	lm	L mm
19AS12K4SX	12W	1487	650
19AS18K4SX	18W	2232	930
19AS24K4SX	24W	2976	1210
19AS30K4SX	30W	3719	1490
19AS36K4SX	36W	4463	1770
19AS48K4SX	48W	5950	2330

Cod. 3000K	Icon	lm	L mm
19AS12K3SX	12W	1439	650
19AS18K3SX	18W	2158	930
19AS24K3SX	24W	2878	1210
19AS30K3SX	30W	3597	1490
19AS36K3SX	36W	4316	1770
19AS48K3SX	48W	5755	2330

QI AS-SX HIGH POWER

IP 40

Polycarbonate lens for asymmetrical beam.
Maximum installation height: 3 meters.

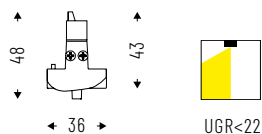

Cod. 4000K	Icon	lm	L mm
19AS24K4HPSX	24W	2976	650
19AS36K4HPSX	36W	4463	930
19AS48K4HPSX	48W	5951	1210
19AS60K4HPSX	60W	7438	1490
19AS72K4HPSX	72W	8925	1770
19AS96K4HPSX	96W	11900	2330

Cod. 3000K	Icon	lm	L mm
19AS24K3HPSX	24W	2878	650
19AS36K3HPSX	36W	4316	930
19AS48K3HPSX	48W	5755	1210
19AS60K3HPSX	60W	7194	1490
19AS72K3HPSX	72W	8633	1770
19AS96K3HPSX	96W	11510	2330



APPLICAZIONE QI SU BINARIO



QI APPLICATION ON TRACK

In case of installation of **QI AS** on existing tracks, it is necessary to pay attention to the use of the right or left version of the devices, in order to direct the asymmetrical flow correctly.

The particular «A» of the track must be identified and consequently the luminaire should be chosen between: **QI AS-SX** or **QI AS-DX**.

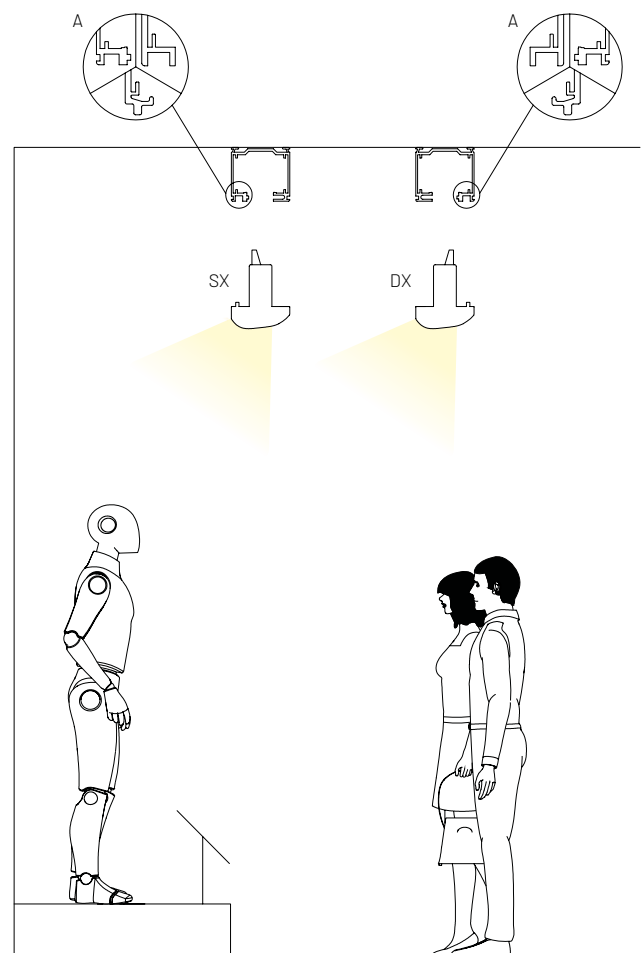



C
H
A
P
T
E
R

S
E
V
E
N

LOW VOLTAGE

Gosthfeed 2.0	206	ID15
Next DK LV	209	ID50
Ben LV	211	ID10
Teres Micro Zoom	213	ID14
Teres LV	215	ID14
Ludo Spot	217	ID20
Ludo Linear 2.0	219	ID20
Ludo Linear DK	221	ID20
Jools LV	223	ID11
Stylo LV	225	ID88

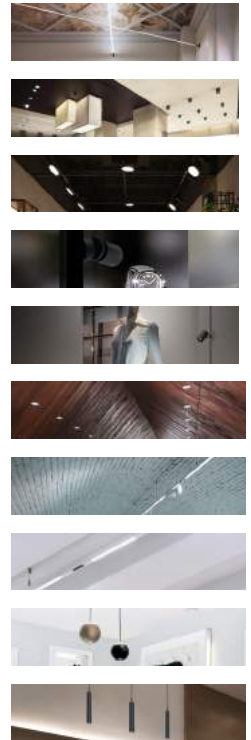

LOW VOLTAGE





GHOSTFEED 2.0

GHOSTFEED 2.0 is the new **single-cable system** that, with a minimal installation impact, is able to create **continuous lines of light** extending up to fifteen meters. The special tensioners require **only two anchoring points**, thus finding space even in those architectural solutions where the presence of the light source must be particularly discreet. The low voltage system of **GHOSTFEED 2.0** allows the installation of LED strips for **direct and indirect light**; further versatility is conferred by accessories such as diffusing optics, blind modules and adjustable micro-spots for accent lighting.







ID 15



FEATURES

-  Direct/Indirect emission
-  UGR <22;
-  IP 40

LED

-  2700K/3000K/4000K
-  >100lm/W
-  CRI >90
-  Eye safety: RG0/RG1
-  Mac Adams 3
-  L80/B10 >50.000h

CERTIFICATIONS

-  EEA Conformity
-  Energy efficiency
-  5 years warranty

ON REQUEST

-  DALI - code D*
-  Bluetooth - code BT*

SPECIFICATIONS

Remote driver.
Diffuser in satin methacrylate for direct / indirect emission.

BODY

Steel sheet with epoxy powders coating.

COLORS

White wrinkled matte RAL 9003 - code W
Black RAL 9005 matte - code BK

* Where available

GHOSTFEED 2.0

Accessories on page 208. **IP 40**

Kit of two die-cast aluminum wall tensioners and metal support strip.

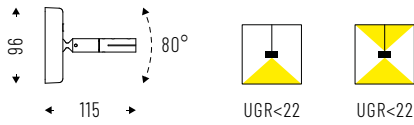

Cod	m
15GF5	5
15GF10	10
15GF15	15

GHOSTFEED STRIP

Accessories on page 208. **IP 20**

Adhesive LED strip 48V CRI > 90, 10W/m. Length 5000mm, sectionable every 25mm.



Cod. 4000K	☼	lm/mt	mm
15SL10K4	10W	940	5000

Cod. 3000K	☼	lm/mt	mm
15SL10K3	10W	813	5000

Cod. 2700K	☼	lm/mt	mm
15SL10K27	10W	760	5000

GHOSTFEED SPOT ZOOM

Accessories on page 208. **IP 40**

Micro spot with adjustable beam from 10° to 40° including attack for Ghostfeed 2.0.

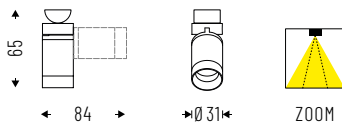

Cod. 4000K	☼	lm
15ZM3K4GF	3W	262
15ZM7K4GF	7W	560

Cod. 3000K	☼	lm
15ZM3K3GF	3W	238
15ZM7K3GF	7W	510

Cod. 2700K	☼	lm
15ZM3K27GF	3W	221
15ZM7K27GF	7W	474

ACCESSORIES



PG satin diffuser,
for direct/indirect light.

- 15PG1000** L. 1000 mm
- 15PG2000** L. 2000 mm
- 15PG3000** L. 3000 mm



Blind module, available
in White and Black.

- 15MC1000** L. 1000mm
- 15MC2000** L. 2000mm
- 15MC3000** L. 3000mm



Quick connector for
strip-cable connection.

15AA09CR



Quick connector for
strip-strip connection.

15AA11SS



48V - 75W and 150W driver
for remote installation.

- 15LV7548IS**
- 15LV15048IS**

TECHNICAL NOTES





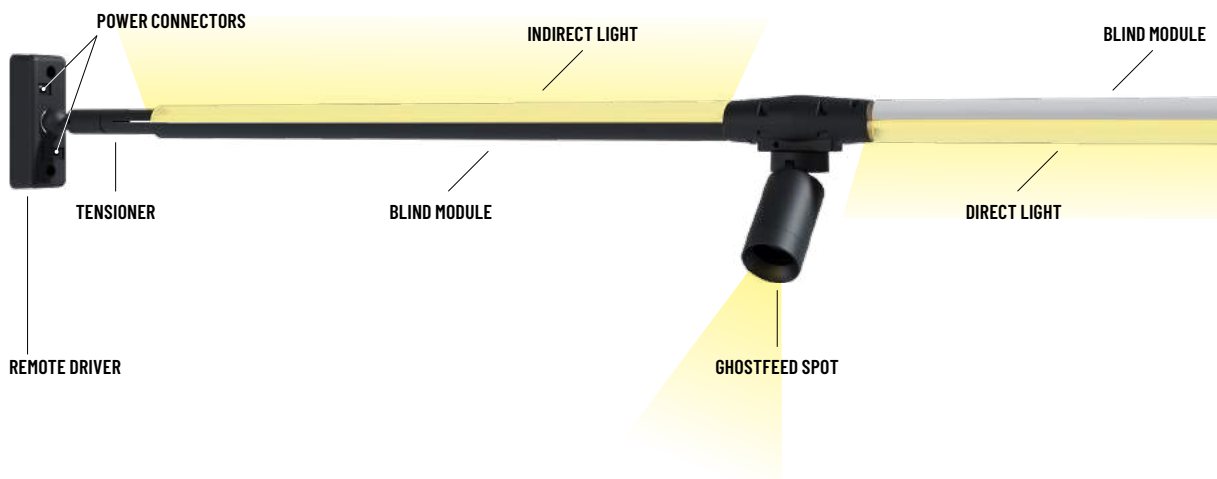

CONFIGURATION EXAMPLE

Maximum length of the metal band: 15m.







Two-point wall anchoring. 40 degrees of maximum inclination towards the wall mount.



FEATURES

-  Direct emission
-  Direct/Indirect emission
-  UGR <16
-  IP 40



LED

-  3000K/4000K
-  >107 lm/W
-  CRI >90
-  Eye safety: R60/R61
-  Mac Adams 3
-  L80/B10 >50.000h

CERTIFICATIONS

-  EEA Conformity
-  Energy efficiency
-  5 years warranty

ON REQUEST

-  DALI - code D*
-  Bluetooth - code BT*

SPECIFICATIONS

Operation at 48V VDC
High Contrast Diffuser UGR<16

BODY

Aluminum with epoxy powder coated

COLORS

White RAL 9003 wrinkled
- code W
Black RAL 9005 wrinkled
- code BK

RELATED PRODUCTS

Next (P. 166)
Next IP66 (P. 169)

* Where available
For SWITCHDIM command use DIMTDS (na. 337)

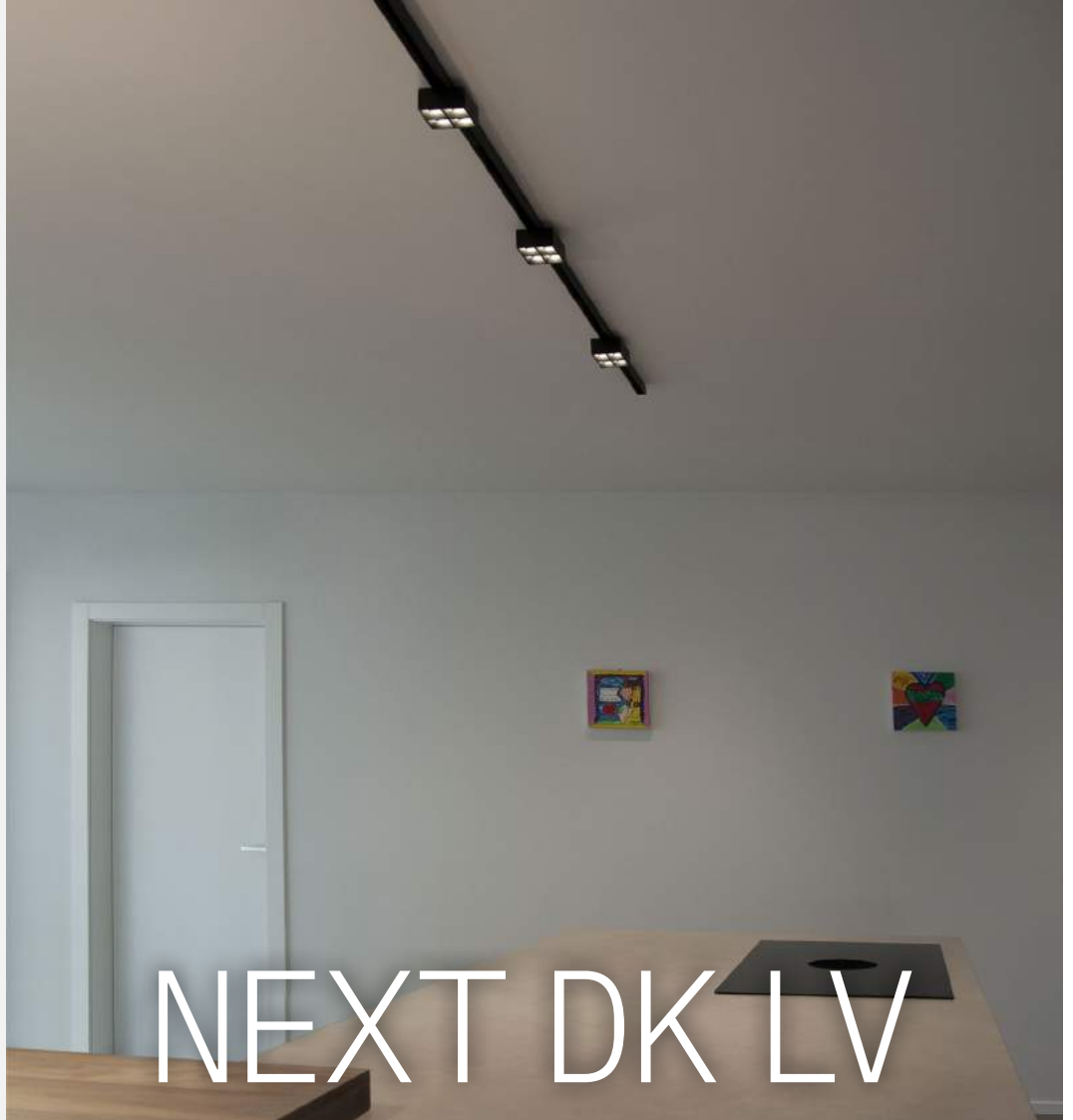

NEXT DK LV is the new luminaire with a **contemporary design** that perfectly fits into those contexts where architectural design requires sober and minimal shapes. Compatible with both surface-mounted and recessed low voltage tracks.

ID 50





LOW VOLTAGE

NEXT^{DK LV}

IP 40

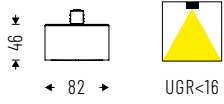
High Contrast Diffuser, UGR <16.
Installablr on 48V low voltage tracks.



Cod. 4000K		lm	L mm
50DK11K4LV	11W	875	82

Cod. 3000K		lm	L mm
50DK11K3LV	11W	830	82

FEATURES

 Direct emission

 UGR <22

 IP 40

LED

 3000K/4000K

 >78 lm/W

 CRI >90

 Eye safety: R60/R61

 Mac Adams 3

 L80/B10 >50.000h

CERTIFICATIONS

 EEA Conformity

 5 years warranty

 Energy efficiency

ON REQUEST

 DALI - code D*

 Bluetooth - code BT*

SPECIFICATIONS

48V DC operation.
SMD LED technology.
PG diffuser for homogeneous
emission UGR <22.

BODY

Aluminum with epoxy
powder coating.

COLORS

White RAL 9003 wrinkled
- code W
Black RAL 9005 wrinkled
- code BK

RELATED PRODUCTS

Ben suspended (P. 84)
Ben recessed (P. 124)
Ben wall (P. 249)
Ben IP54 (P. 315)

* Where available

For SWITCHDIM command use DIMTDS (no. 337)



BEN LV

The **BEN** luminaire expands with a new **low voltage technology** component. The PG optic with satin diffuser and silk-screened perimeter and the **joint at the base** make it possible to rotate and adjust **BEN LV** to illuminate any environment in a widespread, simple and effective way.

ID 10





BEN LV

IP 40

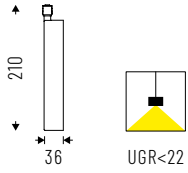
Impact resistant satin polycarbonate diffuser.



Cod. 4000K		lm	L mm
10PG12K4LV	12W	931	200x210

Cod. 3000K		lm	L mm
10PG12K3LV	12W	879	200x210



TECHNICAL NOTES







BODY ROTATION



FEATURES

-  Direct emission
-  UGR <19
-  IP40



LED

-  3000K/4000K
- >80 lm/W icon" data-bbox="71 238 98 256"/> >80 lm/W
-  CRI >90
-  Eye safety: R60/R61
-  Mac Adams 3
-  L80/B10 >50.000h

CERTIFICATIONS

-  EEA Conformity
-  Energy efficiency
-  5 years warranty

ON REQUEST

-  DALI - code D
-  Bluetooth - code BT*
-  2700K - code K27*

SPECIFICATIONS

Built-in driver.
48V DC operation.
Lens with adjustable
beam, from 10° to 40°.
Honeycomb optic.

BODY

Die-cast aluminum with
epoxy powder coating.

COLORS

White RAL 9003 wrinkled
- code W
Black RAL 9005 wrinkled
- code BK

RELATED PRODUCTS

Teres (P. 188)
Teres Exte (P. 195)
Teres IP66 (P. 309)

* Where available
For SWITCHDIM command see DIMTDS (pg. 337)



TERES also takes up space in the world of Low Voltage and integrates the **MICRO ZOOM** version with adjustable beam lens. The result is a spot with **extremely contained dimensions**: with a diameter of 31 mm, **powered at 48V**, it is ideal for accent lighting in prestigious environments.

ID 14



TERES MICRO ZOOM 1X

IP 40

Lens with adjustable beam from 10° to 40°.

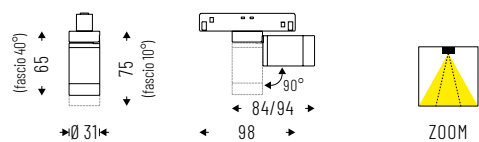

Cod. 4000K		lm	Ø mm
14ZM3K4NLV	1X3W	262	31
14ZM7K4NLV	1X7W	560	31



Cod. 3000K		lm	Ø mm
14ZM3K3NLV	1X3W	238	31
14ZM7K3NLV	1X7W	510	31

TERES MICRO ZOOM 2X

IP 40

Lens with adjustable beam from 10° to 40°.

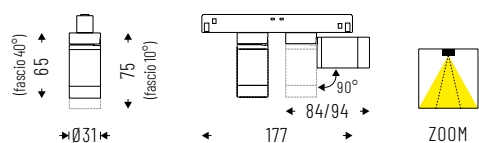



Cod. 4000K		lm	Ø mm
14ZM23K4NLV	2X3W	524	31
14ZM27K4NLV	2X7W	1120	31









Cod. 3000K		lm	Ø mm
14ZM23K3NLV	2X3W	476	31
14ZM27K3NLV	2X7W	1020	31

FEATURES

-  Direct emission
-  UGR <19
-  IP40



LED

-  3000K/4000K
-  >105 lm/W
-  CRI >90
-  Eye safety: R60/R61
-  Mac Adams 3
-  L80/B10 >50.000h

CERTIFICATIONS

-  EEA Conformity
-  Energy efficiency
-  5 years warranty

ON REQUEST

-  DALI - code D
-  Bluetooth - code BT*
-  2700K - code K27*
5000K - code K5*

SPECIFICATIONS

Built-in driver.
48V DC operation.
CoB LED technology.
Internal aluminum reflectors:
beam angles: 15°- 20°- 36°- 50°

BODY

Die-cast aluminum with
epoxy powder coating.

COLORS

White RAL 9003 wrinkled
- code W
Black RAL 9005 wrinkled
- code BK

RELATED PRODUCTS

LV Track (P. 184)
Teres Micro Zoom (P. 147)
Teres (P. 188)
Teres Exte (P. 195)
Teres IP66 (P. 309)

* Where available
For SWITCHDIM command use DIMTDS (p. 337)



TERES LV completes the wide range of TERES with the Low Voltage 48V version with track coupling. **Elegant and minimal**, thanks to the CRI > 90 modules and the **wide range of optics**, it meets all the needs of the retail and accent lighting world.

ID 14



LOW VOLTAGE

TERES LV

IP 40

Clear glass with internal aluminum reflectors.
Beam angles: 15° - 20° - 36° - 50°.

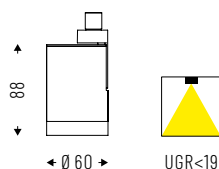

Cod. 4000K	Icon	lm	Ø mm
14VT12K415LV	12W 15°	1259	60
14VT12K420LV	12W 20°	1259	60
14VT12K436LV	12W 36°	1259	60
14VT12K450LV	12W 50°	1259	60

Cod. 3000K	Icon	lm	Ø mm
14VT12K315LV	12W 15°	1177	60
14VT12K320LV	12W 20°	1177	60
14VT12K336LV	12W 36°	1177	60
14VT12K350LV	12W 50°	1177	60

ACCESSORIES



TERES OPTICS



TERES LV
frost glass

14AA6MLV



TERES LV
micro-engraved optics

14AASLLV

ANTI-GLARE RINGS

Anti-glare rings that allow to focus the light beam hiding the light source. They perfectly fit in art galleries, museums and retail areas to value the subject with accent light without annoying glare issues.



14AA60AGW
Internal / external color:
White RAL 9003





14AA60AGWBK
Internal color: Black RAL 9005
External color: White RAL 9003









14AA60AGBK
Internal / external color:
Black RAL 9005

FEATURES

-  Direct emission
-  UGR <19
-  IP40



LED

-  3000K/4000K
-  >95 lm/W
-  CRI >90
-  Eye safety: R60/R61
-  Mac Adams 3
-  L80/B10 >50.000h

CERTIFICATIONS

-  EEA Conformity
-  Energy efficiency
-  5 years warranty

ON REQUEST

-  DALI - code D
-  Bluetooth - code BT*

SPECIFICATIONS

Built-in driver.
48V DC operation.
SMD LED technology.
LN PMMA lens 45° emission.
AS PMMA lens wall-washer emission.

BODY

Die-cast aluminum with epoxy powder coating.

COLORS

White RAL 9003 wrinkled
- code W
Black RAL 9005 wrinkled
- code BK

RELATED PRODUCTS

LV Track (P. 184)

* Where available

For SWITCHDIM command use DIMTDS (no. 337)

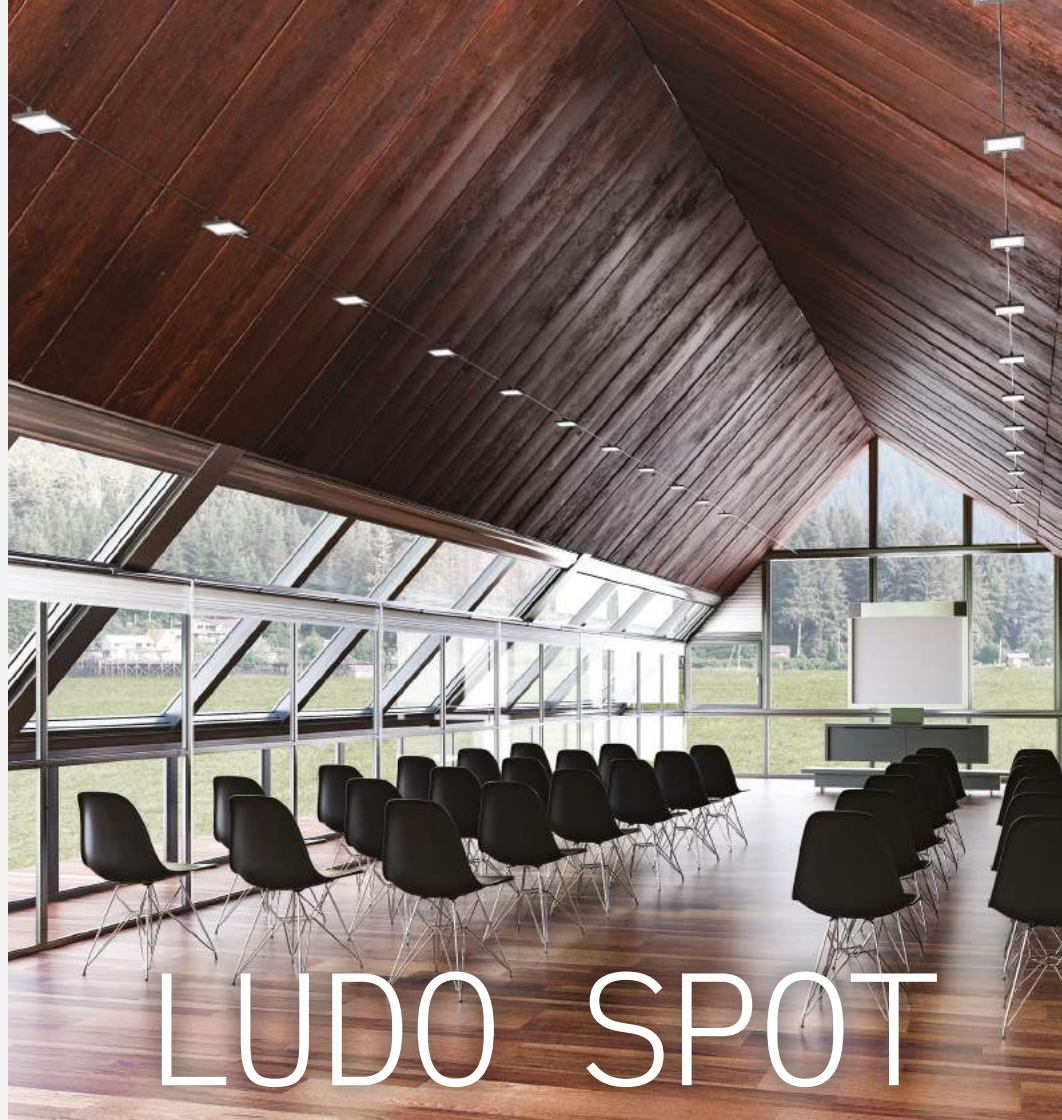

LUDO SPOT is the innovative spot powered at 48V ideal for accent lighting or wall washer lighting. The originality of the design and the flexibility derived from the pivot points make it **extremely versatile** in any type of context. **LUDO SPOT** can only be used with Low Voltage tracks.

ID 20



LUDO SPOT^{LN}

IP 40

PMMA lens 45° emission.

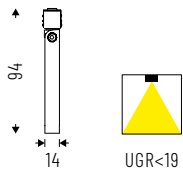

Cod. 4000K		lm	L mm
20LN10K445	10W	950	129

Cod. 3000K		lm	L mm
20LN10K345	10W	855	129

LUDO SPOT^{AS}

IP 40

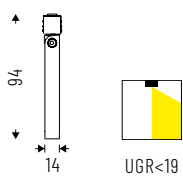

PMMA lens for wall washer emission.









Cod. 4000K		lm	L mm
20AS10K4	10W	977	129

Cod. 3000K		lm	L mm
20AS10K3	10W	897	129

FEATURES

-  Direct emission
-  UGR <16; <22
-  IP40



LED

-  3000K/4000K
-  >120 lm/W
-  CRI >90
-  Eye safety: R60/R61
-  Mac Adams 3
-  L80/B10 >50.000h

CERTIFICATIONS

-  EEA Conformity
-  Energy efficiency
-  5 years warranty

ON REQUEST

-  DALI - code D*
-  Bluetooth - code BT**
-  2700K - code K27**

SPECIFICATIONS

48V DC operation.
SMD LED technology.
PG diffuser in satin methacrylate for homogeneous emission (UGR <22).
Diffuser with CLD collimated optics (UGR <16).

BODY

Anodized aluminum.

COLORS

White RAL 9003 - code B
Black RAL 9011 - code C8

RELATED PRODUCTS

LV Track (P. 184)



LUDO LINEAR 2.0 is the linear luminaire for **low voltage tracks**, dimmable and equipped with PG optics for **homogeneous emission** (UGR <22) or CLD collimated optics **with controlled emission** (UGR <16). Thanks to the quick fixing, **LUDO LINEAR 2.0** is extremely versatile and becomes ideal for the retail world or contemporary living areas.

ID 20



LOW VOLTAGE

*Where available
For SWITCHDIM command see DIMTDS (pg. 337)

LUDO LINEAR 2.0^{PG}

IP 40

PG diffuser in satin-finished methacrylate for homogeneous emission, UGR<22.

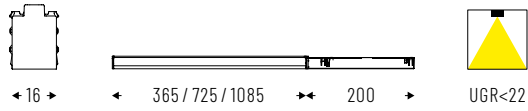

Cod. 4000K	☼	lm	L mm
20PG6K4	6W	708	365
20PG12K4	12W	1416	725
20PG18K4	18W	2124	1085

Cod. 3000K	☼	lm	L mm
20PG6K3	6W	649	365
20PG12K3	12W	1298	725
20PG18K3	18W	1947	1085

LUDO LINEAR 2.0^{CLD}

IP 40

Direct emission with CLD technology, with collimated diffuser, UGR<16.

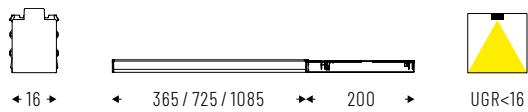

Cod. 4000K	☼	lm	L mm
20CLD6K4	6W	616	365
20CLD12K4	12W	1232	725
20CLD18K4	18W	1848	1085

Cod. 3000K	☼	lm	L mm
20CLD6K3	6W	565	365
20CLD12K3	12W	1129	725
20CLD18K3	18W	1694	1085

FEATURES

 Direct emission

 UGR <16

 IP40

LED

 3000K/4000K

 >96 lm/W

 CRI >90

 Eye safety: R60/R61

 Mac Adams 3

 L80/B10 >50.000h

 DALI standard*

CERTIFICATIONS

 EEA Conformity

 Energy efficiency

 5 years warranty

ON REQUEST

 2700K - code K27*

SPECIFICATIONS

48V DC operation.
DALI standard.
High Contrast UGR <16
PC microlenses diffuser.

BODY

Polycarbonate.

COLORS

White RAL 9003 - code B
Black RAL 9005 - code C8

RELATED PRODUCTS

LV Track (P. 184)



LUDO LINEAR DK is a linear lighting element with **High Contrast microcell optics** and high glare control. **Operating at 48V for Low Voltage tracks**, it is a winning solution that stands out for its minimalism and essentiality in forms, functionality and technical performance.

ID 20



LOW VOLTAGE

*Where available
For SWITCHDIM command see DIMTDS (pg. 337)

LUDO LINEAR DK

IP 40

High Contrast diffuser UGR <16 with PC lens.
Beam angle: 60°.

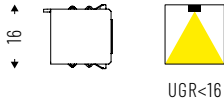

Cod. 4000K	☼	lm	L mm
20DK10K460D	10W 60°	815	380

Cod. 3000K	☼	lm	L mm
20DK10K360D	10W 60°	750	380

TECHNICAL NOTES



FIXING SYSTEM AND POWER SUPPLY



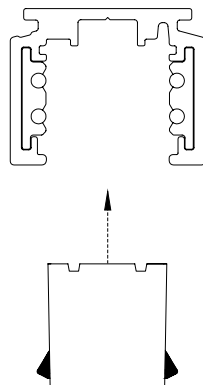

Low voltage track



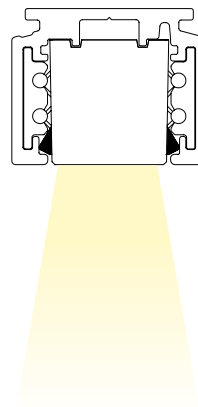





Quick application
on track



FEATURES

-  Direct/Indirect emission
-  UGR <19
-  IP 40



LED

-  3000K/4000K
-  >99 lm/W
-  CRI >90
-  Eye safety: R60/R61
-  Mac Adams 3
-  L80/B10 >50.000h

CERTIFICATIONS

-  EEA Conformity
-  Energy efficiency
-  5 years warranty

ON REQUEST

-  DALI - code D*
-  Bluetooth - code BT*
-  2700K - code K27*
5000K - code K5*

SPECIFICATIONS

CoB LED technology.
Indirect emission in diffusing satin PC.
Direct emission with PC lens.
Cut off > 30°

BODY

Aluminum with epoxy powder coating.

COLORS

White RAL 9003 - code W
Black RAL 9005 - code BK
Anodized champagne - code C67

RELATED PRODUCTS

Jools suspended/ceiling (P. 96)
LV Track (P. 184)

*Where available
For SWITCHDIM command use DIMTDS (na. 337)



JOOLES LV

JOOLES LV is the elegant suspension lamp in aluminum for application on LV track. **Compact but powerful**, with double emission, it is suitable for professional, retail and residential contexts, thanks to the strong decorative component.

ID 11



Design
Serge & Robert Cornelissen

JOOLES LV

IP 40

Diffused satin PC for indirect emission. Direct emission with PC lens. CUT-OFF F>30°. Beam angles: 14° - 35° - 55°.

Power supply box requested for installation, see accessories.

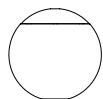

Ø 150 / 200 / 250 mm



UGR < 19



Cod. 4000K	Beam	lm	Ø mm
11DI19K414	19W 14°: 12W+7W	1881	150
11DI19K435	19W 35°: 12W+7W	1881	150
11DI19K455	19W 55°: 12W+7W	1881	150
11DI22K414	22W 14°: 14W+8W	2106	200
11DI22K435	22W 35°: 14W+8W	2106	200
11DI22K455	22W 55°: 14W+8W	2106	200
11DI27K414	27W 14°: 17W+10W	2498	250
11DI27K435	27W 35°: 17W+10W	2498	250
11DI27K455	27W 55°: 17W+10W	2498	250

Cod. 3000K	Beam	lm	Ø mm
11DI19K314	19W 14°: 12W+7W	1768	150
11DI19K335	19W 35°: 12W+7W	1768	150
11DI19K355	19W 55°: 12W+7W	1768	150
11DI22K314	22W 14°: 14W+8W	1980	200
11DI22K335	22W 35°: 14W+8W	1980	200
11DI22K355	22W 55°: 14W+8W	1980	200
11DI27K314	27W 14°: 17W+10W	2349	250
11DI27K335	27W 35°: 17W+10W	2349	250
11DI27K355	27W 55°: 17W+10W	2349	250

ACCESSORIES



Power supply / suspension for Low Voltage 48V track, ON/OFF version.

11AA16LV



Power supply / suspension for Low Voltage 48V track, DALI version.

11AA16LVD

TECHNICAL NOTES



EXAMPLE OF INSTALLATION ON RECESSED LV TRACK



FEATURES

 Direct emission

 UGR <19

 IP 40

LED

 3000K/4000K

 >72 lm/W

 CRI >90

 Eye safety: R60/R61

 Mac Adams 3

 L80/B10 >50.000h

CERTIFICATIONS

 EEA Conformity

 Energy efficiency

 5 years warranty

ON REQUEST

 DALI - code D*

 Bluetooth - code BT*

 2700K - code K27*
5000K - code K5*

SPECIFICATIONS

25°- 40° polycarbonate lens.
Honeycomb optic.
Diffusing decorative screen.

BODY

Die-cast aluminum with
epoxy powder coating.

COLORS

White RAL 9003 wrinkled
- code W
Black RAL 9005 wrinkled
- code BK

RELATED PRODUCTS

Stylo Suspended (P. 98)
LV Track (P. 184)

*Where available

For SWITCHDIM command use DIMTDS (n. 337)



STYLO LV

STYLO LV is a **miniaturized suspended element** with a minimal but elegant design that can be installed on low voltage 48V tracks. Excellent glare control through a cut-off angle of over thirty degrees.

ID 88



LOW VOLTAGE

STYLO LV

IP 40

Polycarbonate lens. Beam angles: 25°-40°.

1.5 m of suspension / power supply cable included..

Power supply box requested for installation, see accesories.

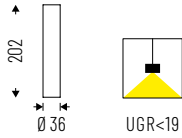

Cod. 4000K	Icon	lm	Ø mm
88PC5K425	5W 25°	360	36
88PC5K440	5W 40°	360	36
88PC8K425	8W 25°	574	36
88PC8K440	8W 40°	574	36

Cod. 3000K	Icon	lm	Ø mm
88PC5K325	5W 25°	318	36
88PC5K340	5W 40°	318	36
88PC8K325	8W 25°	508	36
88PC8K340	8W 40°	508	36

ACCESSORIES



Power supply box for Low Voltage 48V track, ON/OFF version.

88AA16ABL



Power supply box for Low Voltage 48V track, DALI version.

88AA16ABLVD



Honeycomb optics

88AAND



Diffusing PG decorative screen.

88AASD



WALL / FLOOR

Toik	228	ID56
Monod	230	ID53
Uplik	239	ID76
Arkeon Wall	247	ID46
Ben	249	ID10



C
H
A
P
T
E
R

E
I
G
H
T

WALL/FLOOR







TOIK

TOIK is the wall luminaire with **soft and minimal lines**. The perfect solution to illuminate passageways and common spaces, enriching them with the decorative and elegant design of the aluminum body. Available in **different lengths and colors**, in the indirect light version and in the direct / indirect bi-emission version, it provides the possibility of integrating daylight sensor, emergency light module and connections for home automation systems. **TOIK** is characterized by its **great technological content** in an essential and compact body, for a **high quality of light and versatility** of use.







ID 56



FEATURES

-  Direct/Indirect emission
-  Emissione Indiretta
-  UGR < 22
-  IP 40





LED

-  3000K/4000K
-  >100lm/W
-  CRI >90
-  Eye safety: R60
-  Mac Adams 3
-  L80/B10 >50.000h

CERTIFICATIONS

-  EEA Conformity
-  Energy efficiency
-  5 years warranty

ON REQUEST

-  DALI - code D
-  Bluetooth - code BT*
-  Built-in PIR/Daylight sensor - code S*
-  Emergency 1 hr - code EM
Emergency 3 hrs - code EM3H*
-  2700K - code K27*

SPECIFICATIONS

Built-in driver.
Antistatic satin methacrylate diffuser for homogeneous emission with UGR <22.

BODY

Aluminum with epoxy powder coating.

COLORS

White RAL 9003 wrinkled - code W
Black RAL 9005 wrinkled - code BK

* Where available

TOIK

IP 40

Antistatic satin methacrylate diffuser
UGR <22 with indirect emission.

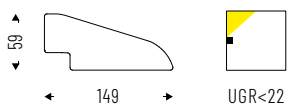

Cod. 4000K	☼	lm	mm
56IN22K4	22W	2389	401
56IN44K4	44W	4770	706
56IN66K4	66W	7150	1011

Cod. 3000K	☼	lm	mm
56IN22K3	22W	2250	401
56IN44K3	44W	4500	706
56IN66K3	66W	6740	1011

TOIK DOUBLE EMISSION

IP 40

Antistatic satin methacrylate diffuser
UGR <22 with direct/indirect emission.

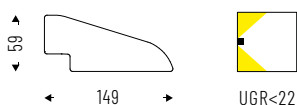

Cod. 4000K	☼	lm	mm
56DI28K4	28W	2771	401
56DI56K4	56W	5540	706
56DI84K4	84W	8305	1011

Cod. 3000K	☼	lm	mm
56DI28K3	28W	2650	401
56DI56K3	56W	5300	706
56DI84K3	84W	7940	1011

TECHNICAL NOTES



AVAILABLE CONFIGURATIONS

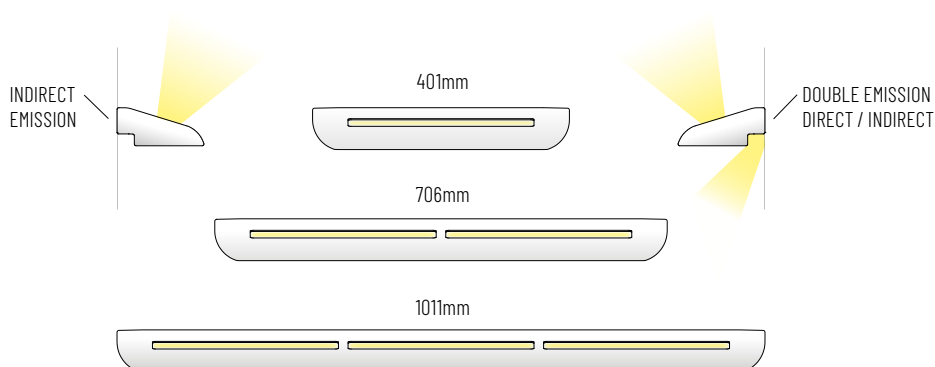

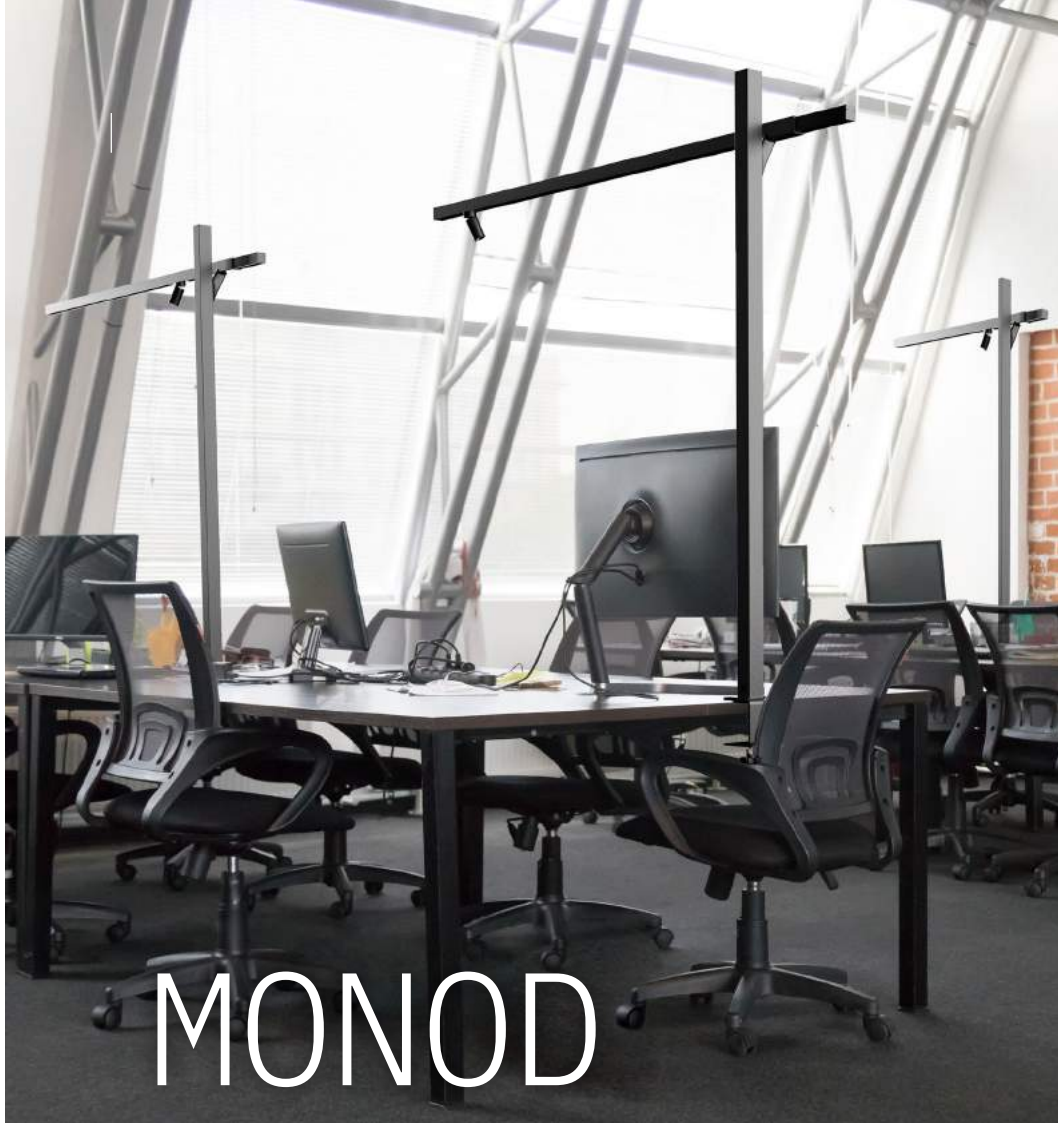

MONOD





MONOD is the new, exclusive product created in collaboration with Cornelissen studio for a concept of **transversal and fluid office**, in which each work station can be modified and adapted to situations in continuous progress: **MONOD**, in fact, in the table or floor version, **allows to manage** at will the light sources, both direct and indirect, choosing between **different fixtures** to be applied at will to the **horizontal low voltage track**. The indirect emission is guaranteed by the **top spot embedded in the stem** in which there are also the **touch button** for switching the light and a **USB port**.

ID 53









Design
Serge & Robert Cornelissen

FEATURES

-  Direct emission
-  Direct/Indirect emission
-  UGR <19; <22
-  IP 40



LED

-  3000K/4000K
-  >94 lm/W
-  CRI >90
-  Eye safety: R60/R61
-  Mac Adams 3
-  L80/B10 >50.000h

CERTIFICATIONS

-  EEA Conformity
-  Energy efficiency
-  5 years warranty

ON REQUEST

-  DALI - code D*
-  2700K - code K27*

SPECIFICATIONS

Built-in driver.
Indirect emission with aluminum reflector. Beam angle 50°.
Direct emission / indirect to be ordered separately among the compatible light sources.

BODY

Aluminum with epoxy powder coating.

COLORS

White RAL 9003 wrinkled
- code W
Black RAL 9005 wrinkled
- code BK

* Where available

MONOD

Light sources on pages 235-237.

IP 40

Desk mounting element with single arm.
Indirect emission integrated in the stem.
Beam angle: 50°.

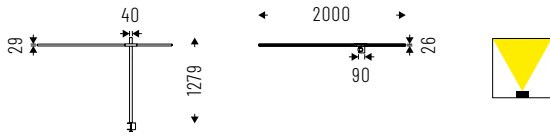

Cod. 4000K		lm	L mm
53AA9K450	9W 50°	972	2000

Cod. 3000K		lm	L mm
53AA9K350	9W 50°	923	2000

Direct emission light sources not included.

MONOD ^{TWIN}

Light sources on pages 235-237.

IP 40

Desk mounting element with double arm.
Indirect emission integrated in the stem.
Beam angle: 50°.

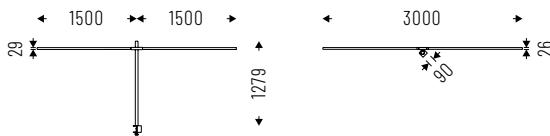

Cod. 4000K		lm	L mm
53AA9K450T	9W 50°	972	3000

Cod. 3000K		lm	L mm
53AA9K350T	9W 50°	923	3000

Direct emission light sources not included.

WALL/FLOOR

MONOD ⁹⁰

Desk mounting element with two single arms at 90°.
Indirect emission integrated in the stem.
Beam angle: 50°.

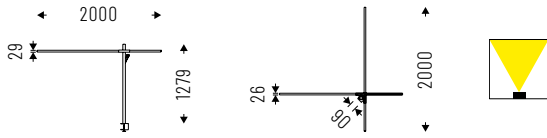

Cod. 4000K	☼	lm	L mm
53AA9K450A90	9W 50°	972	2000

Light sources on pages 235-237.

IP 40



Cod. 3000K	☼	lm	L mm
53AA9K350A90	9W 50°	923	

Direct emission light sources not included.

MONOD ^{CROSS}

Desk mounting element with two double arms at 90°.
Indirect emission integrated in the stem.
Beam angle: 50°.

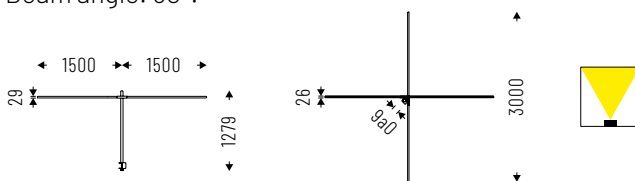

Cod. 4000K	☼	lm	L mm
53AA9K450C	9W 50°	972	3000

Light sources on pages 235-237.

IP 40



Cod. 3000K	☼	lm	L mm
53AA9K350C	9W 50°	923	3000

Direct emission light sources not included.

MONOD FLOOR

Light sources on pages 235-237.

IP 40

Floor support element with single arm.
Indirect emission integrated in the stem.
Beam angle: 50°.

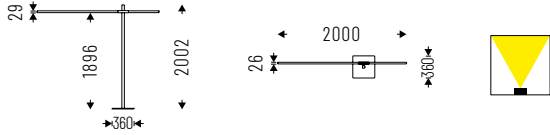

Cod. 4000K		lm	L mm	€
53AA9K450F	9W 50°	972	2000	

Cod. 3000K		lm	L mm
53AA9K350F	9W 50°	923	2000

Direct emission light sources not included.

MONOD TWIN FLOOR

Light sources on pages 235-237.

IP 40

Floor support element with double arm.
Indirect emission integrated in the stem.
Beam angle: 50°.

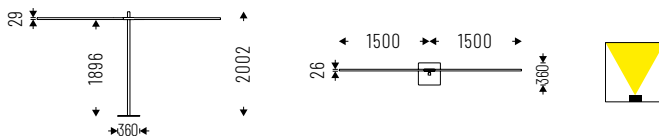

Cod. 4000K		lm	L mm
53AA9K450TF	9W 50°	972	3000

Cod. 3000K		lm	L mm
53AA9K350TF	9W 50°	923	3000

Direct emission light sources not included.

WALL/FLOOR

MONOD 90 FLOOR

Light sources on pages 235-237.

IP 40

Floor support element with two single arms at 90°. Indirect emission integrated in the stem. Beam angle: 50°.

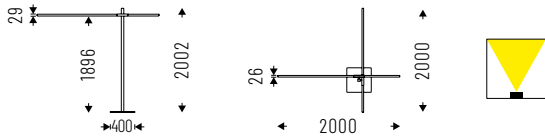

Cod. 4000K		lm	L mm
53AA9K450A90F	9W 50°	972	2000

Cod. 3000K		lm	L mm
53AA9K350A90F	9W 50°	923	2000

Direct emission light sources not included.

MONOD CROSS FLOOR

Light sources on pages 235-237.

IP 40

Floor support element with two double arms at 90°. Indirect emission integrated in the stem. Beam angle: 50°.

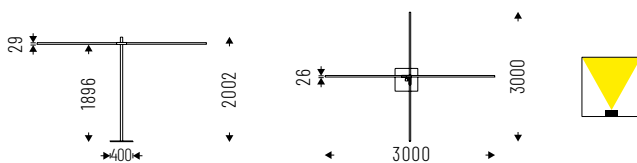

Cod. 4000K		lm	L mm
53AA9K450CF	9W 50°	972	3000

Cod. 3000K		lm	L mm
53AA9K350CF	9W 50°	923	3000

Direct emission light sources not included.

LIGHT SOURCES



LUDO LINEAR 2.0 PG

PG diffuser in extruded opal PMMA, for homogeneous emission, UGR <22.



Cod. 4000K	☼	lm	L mm
20PG6K4	6W	708	365
20PG12K4	12W	1416	725
20PG18K4	18W	2124	1085

Cod. 3000K	☼	lm	L mm
20PG6K3	6W	649	365
20PG12K3	12W	725	725
20PG18K3	18W	1085	1085

LUDO LINEAR 2.0 CLD

Diffuser with CLD technology (collimated optics UGR <16) for environments with VDT.



Cod. 4000K	☼	lm	L mm
20CLD6K4	6W	616	365
20CLD12K4	12W	1232	725
20CLD18K4	18W	1848	1085

Cod. 3000K	☼	lm	L mm
20CLD6K3	6W	565	365
20CLD12K3	12W	1129	725
20CLD18K3	18W	1694	1085

LUDO LINEAR DK

High Contrast diffuser with PC microlenses, UGR <16. Beam angles 60°.



Cod. 4000K	☼	lm	L mm
20DK10K460D	10W 60°	815	380

Cod. 3000K	☼	lm	L mm
20DK10K360D	10W 60°	750	380

WALL/FLOOR

LIGHT SOURCES



BEN LV

Impact resistant polycarbonate diffusers.



Cod. 4000K		lm	mm
10PG12K4LV	12W	931	200x210

Cod. 3000K		lm	mm
10PG12K3LV	12W	879	200x210

TERES MICRO ZOOM

Lens with adjustable beam: from 10° to 40°.



Cod. 4000K		lm	mm
14ZM3K4NLV	1X3W	262	98x75
14ZM7K4NLV	1X7W	560	98x75

Cod. 3000K		lm	mm
14ZM3K3NLV	1X3W	238	98x75
14ZM7K3NLV	1X7W	510	98x75

TERES MICRO ZOOM 2X

Lens with adjustable beam: from 10° to 40°.



Cod. 4000K		lm	mm
14ZM23K4NLV	2X3W	524	177x75
14ZM27K4NLV	2X7W	1120	177x75

Cod. 3000K		lm	mm
14ZM23K3NLV	2X3W	476	177x75
14ZM27K3NLV	2X7W	1020	177x75

LIGHT SOURCES



NEXT DK LV

High Contrast UGR <16 diffuser.



Cod. 4000K		lm	mm
50DK11K4LV	11W	875	82x82

Cod. 3000K		lm	mm
50DK11K3LV	11W	830	82x82

LUDO SPOT LN

PMMA lens, 45° emission.



Cod. 4000K		lm	mm
20LN10K445	10W	950	129x94

Cod. 3000K		lm	mm
20LN10K345	10W	129x94	129x94

MONOD INDIRECT STRIP

LED strip for indirect emission complete with connector and antistatic satin methacrylate diffuser screen, UGR <22.





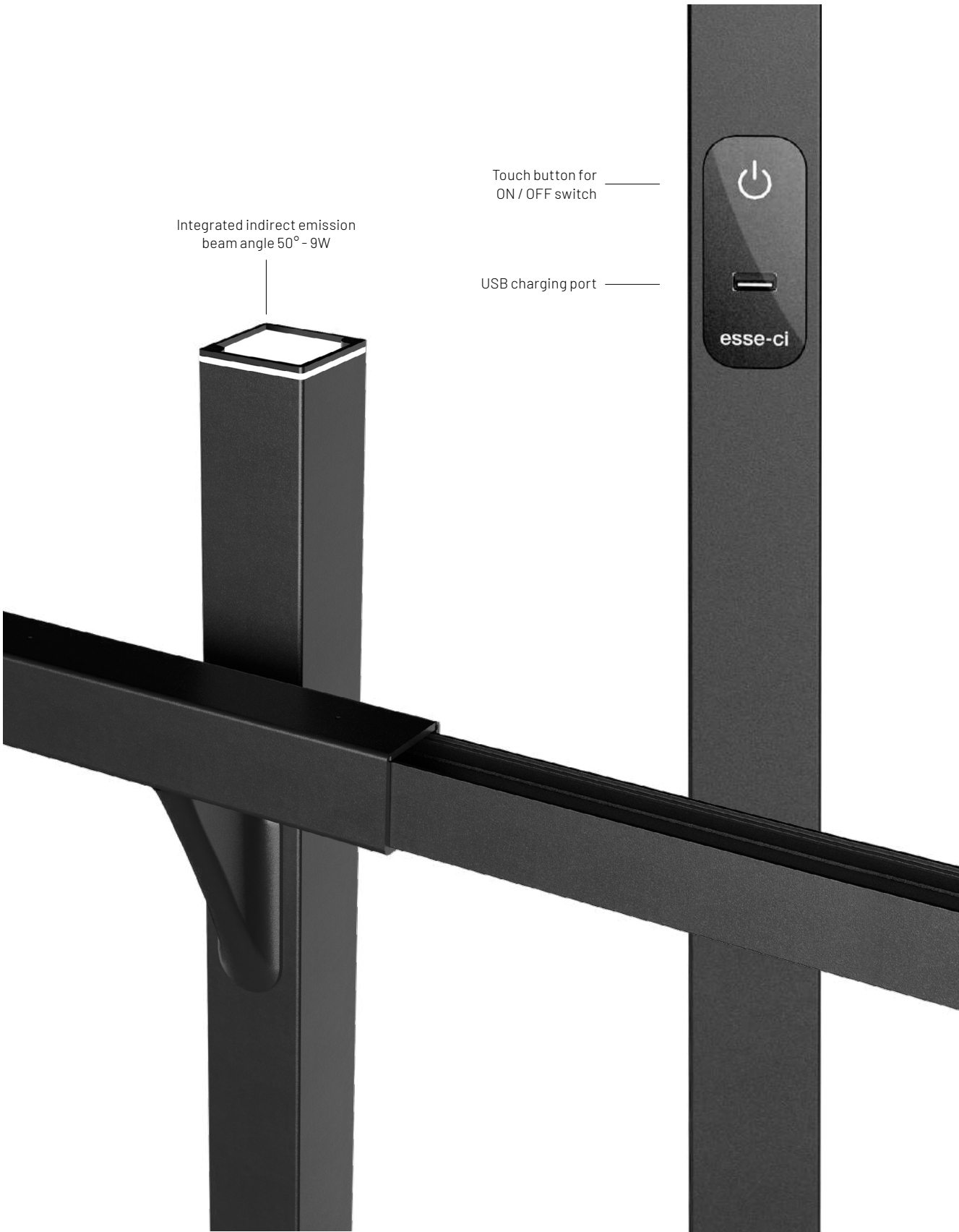

Cod. 4000K		lm	L mm
53SL470K4	4W	336	470
53SL1200K4	10W	858	1200
53SL1410K4	12W	1008	1410

Cod. 3000K		lm	L mm
53SL470K3	4W	299	470
53SL1200K3	10W	763	1200
53SL1410K3	12W	897	1410





TECHNICAL NOTES







FEATURES

-  Direct emission
-  Emissione indiretta
-  Direct/Indirect emission
-  UGR <19; <22
-  IP 40

LED

-  3000K/4000K
- >85 lm/W icon" data-bbox="71 290 98 307"/> >85 lm/W
-  CRI >90
-  Eye safety: RG0/RG1
-  Mac Adams 3
-  L80/B10 >50.000h

CERTIFICATIONS

-  EEA Conformity
-  Energy efficiency per versione LP - HP
-  Energy efficiency per versione XP
-  5 years warranty

ON REQUEST

-  DALI - code D*
-  Emergency 1 hr - code EM
Emergency 3 hrs - code EM3H*
-  2700K - code K27*
5000K - code K5*

SPECIFICATIONS

Built-in driver.
PG diffuser for homogeneous emission UGR <22.
Diffuser with Indirect Light Control (ILC) technology, to favor indirect lighting.
DPL technology diffuser, with controlled UGR<19 for floor version.
Double emission: direct / indirect.

BODY

Aluminum with epoxy powder coating.

COLORS

White RAL 9003 - code B



UPLIK

UPLIK is a wall mounting fixture that, with **its simple and clean lines** fits perfectly in any environment. The different emissions, power, sizes and bright packages offer a very wide range of solutions to meet any lighting requirement. **UPLIK** is also available in the **floor version** for lighting in working environments thanks to **DPL technology diffuser with UGR<19**.

ID 76



WALL/FLOOR

* Where available

UPLIK WALL MINI

IP 40

Methacrylate satin antistatic diffuser screen, UGR<22.
Indirect Light Control (ILC) technology for partially indirect emission.

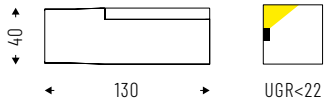

Cod. 4000K		lm	L mm
76DR12K4	12W	1008	175

Cod. 3000K		lm	L mm
76DR12K3	12W	984	175

UPLIK WALL MINI DOUBLE EMISSION

IP 40

Lower methacrylate satin antistatic diffuser screen, UGR<22.
Indirect Light Control (ILC) technology and upper PG protective diffuser for dual emission: direct / indirect.

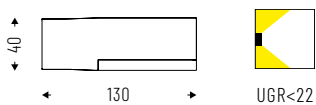

Cod. 4000K		lm	L mm
76DI12K4	12W	1044	175

Cod. 3000K		lm	L mm
76DI12K3	12W	1008	175

UPLIK WALL SMALL

IP 40

Methacrylate satin antistatic diffuser screen, UGR<22.
Indirect Light Control (ILC) technology for partially indirect emission.



Cod. 4000K	☼	lm	L mm
76DR24K4HPS	24W	2016	315
76DR48K4XPS	48W	4080	315

Cod. 3000K	☼	lm	L mm
76DR24K3HPS	24W	1968	315
76DR48K3XPS	48W	3984	315

UPLIK WALL SMALL DOUBLE EMISSION

IP 40

Lower methacrylate satin antistatic diffuser screen, UGR<22.
Indirect Light Control (ILC) technology and upper PG protective diffuser for dual emission: direct / indirect.

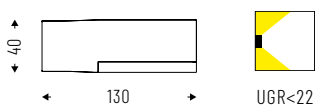

Cod. 4000K	☼	lm	L mm
76DI48K4XPS	48W	4224	315

Cod. 3000K	☼	lm	L mm
76DI48K3XPS	48W	4080	315

WALL/FLOOR

UPLIK WALL MEDIUM

IP 40

Methacrylate satin antistatic diffuser screen, UGR<22.
Indirect Light Control (ILC) technology for partially indirect emission.

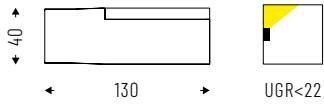

Cod. 4000K	☹	lm	L mm
76DR24K4M	24W	1968	590
76DR48K4HPM	48W	4032	590
76DR62K4XPM	62W	5270	590
76DR96K4XPM	96W	8160	590

Cod. 3000K	☹	lm	L mm
76DR24K3M	24W	1920	590
76DR48K3HPM	48W	3936	590
76DR62K3XPM	62W	5146	590
76DR96K3XPM	96W	7968	590

UPLIK WALL MEDIUM DOUBLE EMISSION

IP 40

Lower methacrylate satin antistatic diffuser screen, UGR<22.
Indirect Light Control (ILC) technology and upper PG protective diffuser for dual emission: direct / indirect.

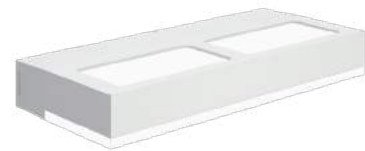
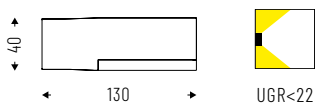

Cod. 4000K	☹	lm	L mm
76DI62K4XPM	62W	5332	590
76DI96K4XPM	96W	8256	590

Cod. 3000K	☹	lm	L mm
76DI62K3XPM	62W	5146	590
76DI96K3XPM	96W	7968	590

UPLIK WALL LONG

IP 40

Methacrylate satin antistatic diffuser screen, UGR<22.
Indirect Light Control (ILC) technology for partially indirect emission.

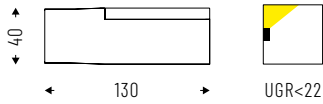

Cod. 4000K	☼	lm	L mm
76DR36K4L	36W	2952	870
76DR72K4HPL	72W	6048	870

Cod. 3000K	☼	lm	L mm
76DR36K3L	36W	2880	870
76DR72K3HPL	72W	5904	870

UPLIK WALL LONG DOUBLE EMISSION

IP 40

Lower methacrylate satin antistatic diffuser screen, UGR<22.
Indirect Light Control (ILC) technology and upper PG protective diffuser for dual emission: direct / indirect.

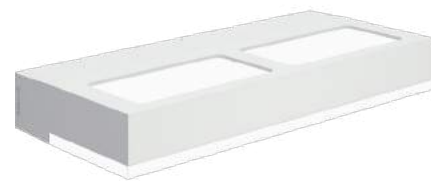
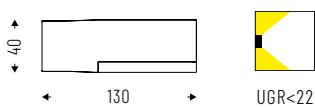

Cod. 4000K	☼	lm	L mm
76DI93K4XPL	93W	7568	870
76DI144K4XPL	144W	12104	870

Cod. 3000K	☼	lm	L mm
76DI93K3XPL	93W	7119	870
76DI144K3XPL	144W	11052	870

UPLIK FLOOR

IP40

Diffuser with Diamond Prism Technology UGR <19 for environments with display screen equipment. Indirect Light Control (ILC) technology for partially indirect emission.

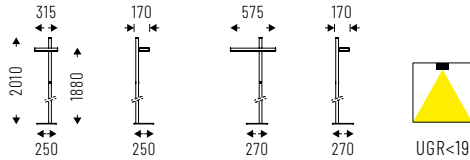

Cod. 4000K	☼	lm	L mm
76DPL48K4D	48W	3880	315
76DPL96K4D	96W	7776	575

Cod. 3000K	☼	lm	L mm
76DPL48K3D	48W	3840	315
76DPL96K3D	96W	7680	575

UPLIK FLOOR DOUBLE EMISSION

IP40

Lower diffuser with Diamond Prism Technology UGR<19 for environments with display screen equipment. Indirect Light Control (ILC) technology for partially indirect emission. Upper PG protective diffuser for dual emission: direct / indirect.

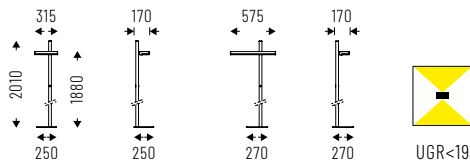

Cod. 4000K	☼	lm	L mm
76DI48DPLK4D	48W	3984	315
76DI96DPLK4D	96W	7968	575

Cod. 3000K	☼	lm	L mm
76DI48DPLK3D	48W	3936	315
76DI96DPLK3D	96W	7872	575

UPLIK FLOOR TWIN

IP 40

Diffuser with Diamond Prism Technology UGR <19 for environments with display screen equipment. Indirect Light Control (ILC) technology for partially indirect emission.

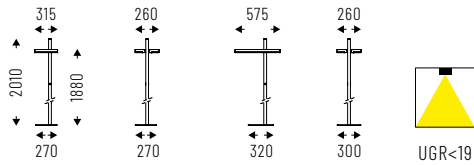

Cod. 4000K	☼	lm	L mm
76DPL96K4TD	96W	7776	315
76DPL192K4TD	192W	15552	575

Cod. 3000K	☼	lm	L mm
76DPL96K3TD	96W	7680	315
76DPL192K3TD	192W	15360	575

UPLIK FLOOR TWIN DOUBLE EMISSION

IP 40

Lower diffuser with Diamond Prism Technology UGR<19 for environments with display screen equipment. Indirect Light Control (ILC) technology for partially indirect emission. Upper PG protective diffuser for dual emission: direct / indirect

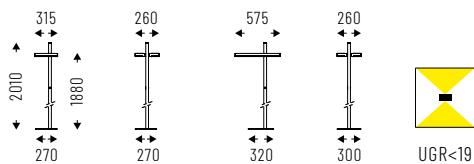

Cod. 4000K	☼	lm	L mm
76DI96DPLK4TD	96W	7968	315
76DI192DPLK4TD	192W	15936	575

Cod. 3000K	☼	lm	L mm
76DI96DPLK3TD	96W	7872	315
76DI192DPLK3TD	192W	15774	575

UPLIK FLOOR TWIN INTELLIGENT

IP 40

Diffuser with Diamond Prism Technology UGR <19 for environments with display screen equipment. Indirect Light Control (ILC) technology for partially indirect emission.

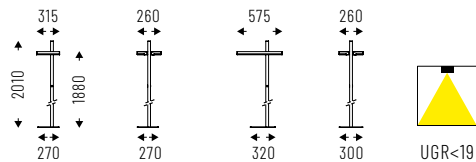

Cod. 4000K	☼	lm	L mm
76DPL96K4TI	96W	7776	315
76DPL192K4TI	192W	15552	575

Cod. 3000K	☼	lm	L mm
76DPL96K3TI	96W	7680	315
76DPL192K3TI	192W	15360	575

UPLIK FLOOR TWIN INTELLIGENT DOUBLE EMISSION

IP 40



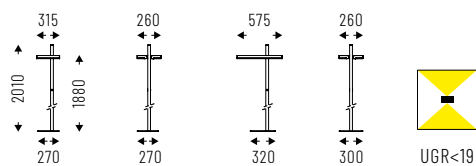

Lower diffuser with Diamond Prism Technology UGR<19 for environments with display screen equipment. Indirect Light Control (ILC) technology for partially indirect emission. Upper PG protective diffuser for dual emission: direct / indirect.









Cod. 4000K	☼	lm	L mm
76DI96DPLK4TI	96W	7968	315
76DI192DPLK4TI	192W	15936	575

Cod. 3000K	☼	lm	L mm
76DI96DPLK3TI	96W	7872	315
76DI192DPLK3TI	192W	15744	575

FEATURES

-  Direct emission
-  Direct/Indirect emission
-  UGR <22
-  IP 40



LED

-  3000K/4000K
-  >116 lm/W
-  CRI >90
-  Eye safety: RG0/RG1
-  Mac Adams 3
-  L80/B10 >50.000h

CERTIFICATIONS

-  EEA Conformity
-  Energy efficiency
-  5 years warranty

ON REQUEST

-  DALI - code D*
-  Emergency 1 hr - code EM*
Emergency 3 hrs - code EM3H*
-  2700K - code K27*
6500K - code K65*

SPECIFICATIONS

Built-in driver.
Satin diffuser UGR <22
for direct emission.
Asymmetrical polycarbonate
lens for indirect emission.

BODY

Aluminum with
epoxy powder coating.

COLORS

White RAL 9003 - code B
Black RAL 9005 -code C8

RELATED PRODUCTS

Arkeon (P. 17)
Arkeon Med (P. 282)

* Where available

ARKEON WALL

ARKEON WALL is designed to perfectly compliment the main ARKEON collection, to ensure specifiers a complete product portfolio to complete any design project. It features the same **minimal dimensions and aesthetic cleanliness**, but it is created specifically as a versatile wall fixture. The numerous sizes and range flexibility make it perfect to illuminate circulation spaces such as corridors, stairwells and landings, for any project type including commercial, hospitality, education and health care.

ID 46

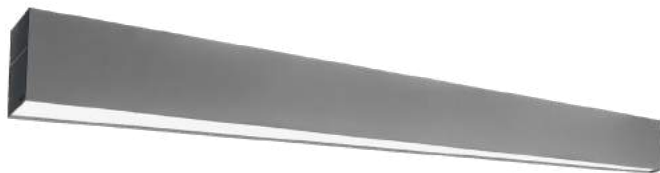

ARKEON WALL

IP 40

Direct emission with frosted diffuser, UGR<22.

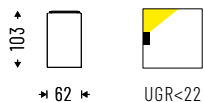

Cod. 4000K	Icon	lm	L mm
46DR10K4	10W	1090	288
46DR20K4	20W	2180	568
46DR30K4	30W	3270	848
46DR70K4	70W	7630	1978

Cod. 3000K	Icon	lm	L mm
46DR10K3	10W	1014	288
46DR20K3	20W	2027	568
46DR30K3	30W	3041	848
46DR70K3	70W	7096	1978

ARKEON WALL DOUBLE EMISSION

IP 40

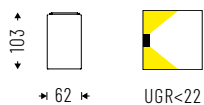

Direct emission with frosted diffuser, UGR<22.
Indirect emission with asymmetric lens.









Cod. 4000K	Icon	lm	L mm
46DI20K4	20W: 10W+10W	2289	288
46DI40K4	40W: 20W+20W	4578	568
46DI60K4	60W: 30W+30W	6867	848
46DI140K4	140W: 70W+70W	16023	1978

Cod. 3000K	Icon	lm	L mm
46DI20K3	20W: 10W+10W	2121	288
46DI40K3	40W: 20W+20W	4257	568
46DI60K3	60W: 30W+30W	6386	848
46DI140K3	140W: 70W+70W	14901	1978

FEATURES

-  Direct emission
-  UGR <22
-  IP 40

LED

-  3000K/4000K
-  >125 lm/W
-  CRI >90
-  Eye safety: R60/R61
-  Mac Adams 3
-  L80/B10 >50.000h

CERTIFICATIONS

-  EEA Conformity
-  Energy efficiency
-  5 years warranty
-  ETL certification

ON REQUEST

-  DALI - code D
-  Bluetooth - code BT*
-  Emergency 1 hr - code EM*
Emergency 3 hrs - code EM3H*
-  2700K - code K27*
-  Human Centric Lighting*

SPECIFICATIONS

Built-in driver.
PG satin-finish shock resistant
acrylic diffuser - with UGR <22

BODY

Aluminum with
epoxy powder coating.

COLORS

Matte white RAL 9003 - code B

RELATED PRODUCTS

BEN suspended/ceiling (P. 84)
BEN recessed (P. 124)
BEN IP54 (P. 315)

* Where available



BEN

BEN is a universal luminaire for wall, ceiling, suspended or recessed installation; its **body is entirely made of aluminum, without welding**. The IP40 version offers both satin and DPL microprismatic diffusers with UGR <19 technology. The mid power LEDs, mounted on circular boards to avoid dark areas, are applied to internal supports with quick connectors for an easy electrification.

ID 10



Design
Serge & Robert Cornelissen

BEN SMALL IP40 PG

IP 40

PG with satin acrylic impact resistant diffuser,
UGR <22.

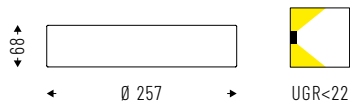

Cod. 4000K	W	lm	Ø mm
10PG6K4	6W	749	257
10PG12K4	12W	1497	257
10PG18K4	18W	2246	257

Cod. 3000K	W	lm	Ø mm
10PG6K3	6W	712	257
10PG12K3	12W	1422	257
10PG18K3	18W	2138	257

BEN MEDIUM IP40 PG

IP 40

PG with satin acrylic impact resistant diffuser,
UGR <22.

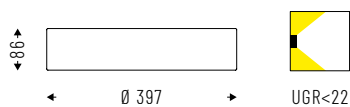

Cod. 4000K	W	lm	Ø mm
10PG16K4	16W	1994	397
10PG25K4	25W	3113	397

Cod. 3000K	W	lm	Ø mm
10PG16K3	16W	1894	397
10PG25K3	25W	2957	397

BEN LARGE IP40 PG

IP 40

PG with satin acrylic impact resistant diffuser,
UGR <22.

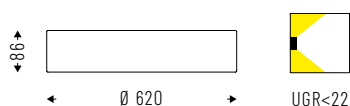







Cod. 4000K	W	lm	Ø mm
10PG60K4	60W	7476	620
10PG112K4	112W	13955	620

Cod. 3000K	W	lm	Ø mm
10PG60K3	60W	7102	620
10PG112K3	112W	13257	620



INDUSTRIAL IP

Ergo	252	ID02	
Ergo Essential	256	ID02	
Linea IP54	259	ID12	
Pmc Evo	262	ID03	
Stilla	264	ID05	
Groove IP54	268	ID43	
Groove Display IP54	271	ID43	

C
H
A
P
T
E
R

N
I
N
E



ERGO

ERGO is the LED luminaire for indoor use in the **industrial, commercial or sport fields**, with single-lens polycarbonate optics for a precise direction of the luminous flux and a wide range of accessories for **ceiling, suspension, wall or recessed application**.

ERGO is designed with the objectives of energy saving, zero maintenance and pollution reduction, thanks to the controlled CO2 emissions. Equipped with built-in driver and power supply cable, it is already set up with twin circuit wiring as standard.







ID 02





FEATURES

-  Direct emission
-  UGR <22
-  IP 65 indoor
-  IK 08; 10
-  -25° / +45°

LED

-  3000K/4000K
-  >142 lm/W
-  CRI >90
-  Eye safety: RG0/RG1
-  Mac Adams 3
-  L80/B10 >50.000h

CERTIFICATIONS

-  EEA Conformity
-  Energy efficiency
-  18032-3 (versione GP)
-  5 years warranty

ON REQUEST

-  DALI - code D
-  Bluetooth - code BT*
-  Emergency 1 hr - code EM
Emergency 3 hrs - code EM3R*
-  5000K - code K5*

SPECIFICATIONS

Built-in driver.
Polycarbonate lens:
concentrating, diffusing,
elliptical or with protective grid.

BODY

Aluminum.
End caps in die-cast aluminum.

COLORS

Black RAL 9005
White RAL 9003 - code B

* Where available

ERGO^{PC}

Accessories on page 255. **IP 65** **IK08**

Polycarbonate lens, symmetrical light distribution.
Equipped with 2000mm long cable.

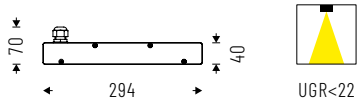

Cod. 4000K	W	lm	L mm
02PC86K465	86W	12190	317
02PC105K465	105W	14329	317
02PC125K465	125W	16068	317
02PC172K465	172W	23913	627
02PC210K465	210W	28171	627
02PC252K465	252W	31681	627

Cod. 3000K	W	lm	L mm
02PC86K365	86W	11459	317
02PC105K365	105W	13469	317
02PC125K365	125W	15103	317
02PC172K365	172W	22478	627
02PC210K365	210W	26481	627
02PC252K365	252W	29780	627

ERGO^{DS}

Accessories on page 255. **IP 65** **IK08**

Polycarbonate lens, wide diffused symmetrical light distribution.
Equipped with 2000mm long cable.

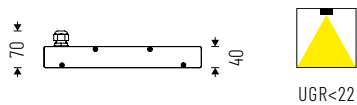

Cod. 4000K	W	lm	L mm
02DS86K465	86W	10439	317
02DS105K465	105W	12314	317
02DS125K465	125W	14061	317
02DS172K465	172W	20830	627
02DS210K465	210W	24247	627
02DS252K465	252W	27691	627

Cod. 3000K	W	lm	L mm
02DS86K365	86W	9812	317
02DS105K365	105W	11576	317
02DS125K365	125W	13217	317
02DS172K365	172W	19580	627
02DS210K365	210W	22792	627
02DS252K365	252W	26030	627

ERGO^{EL}

Accessories on page 5.

IP 65 IK08

Polycarbonate lens, elliptical light distribution.

Equipped with 2000mm long cable.

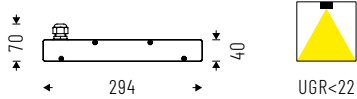

Cod. 4000K	W	lm	L mm
02EL86K465	86W	10943	317
02EL105K465	105W	12671	317
02EL125K465	125W	14531	317
02EL172K465	172W	21543	627
02EL210K465	210W	25683	627
02EL252K465	252W	28626	627

Cod. 3000K	W	lm	L mm
02EL86K365	86W	10286	317
02EL105K365	105W	11911	317
02EL125K365	125W	13660	317
02EL172K365	172W	20250	627
02EL210K365	210W	24142	627
02EL252K365	252W	26909	627

ERGO^{GP}

Accessories on page 5.

IP 65 IK10

Polycarbonate lens with additional protection grid, symmetrical light distribution

Equipped with 2000mm long cable.

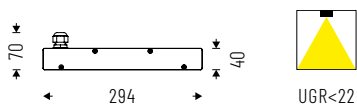

Cod. 4000K	W	lm	L mm
02GP86K465	86W	9237	317
02GP105K465	105W	11028	317
02GP125K465	125W	12502	317
02GP172K465	172W	18394	627
02GP210K465	210W	21820	627
02GP252K465	252W	25069	627

Cod. 3000K	W	lm	L mm
02GP86K365	86W	8682	317
02GP105K365	105W	10366	317
02GP125K365	125W	11751	317
02GP172K365	172W	17290	627
02GP210K365	210W	20510	627
02GP252K365	252W	23563	627

ACCESSORIES



Single wire adjustable suspension kit. 1500mm / 3000mm.

02AA13
02AA1330



Brackets for busbar.

02AA14BS



Bracket for wall installation.

02AA15 - L. 317mm
02AA15252 - L. 627mm



Housing for recessed installation.

02AA17 - L. 317mm
02AA172M - L. 627mm



ERGO ESSENTIAL

ERGO ESSENTIAL is the high bay luminaire designed for interiors of industrial environments, warehouses, supermarkets and exhibition halls. The die-cast aluminum body is characterized by fins for heat dissipation that allow air flows to enter and exit from every direction, guaranteeing an effective cooling. **ERGO ESSENTIAL** polycarbonate lens diffuses the light generated by the individual LEDs with a delicate beam, creating harmonious lighting. Thanks to the special accessories it can be suspended, ceiling or wall-mounted.







ID 02



FEATURES

-  Direct emission
-  UGR < 25
-  IP 65
-  IK 10
-  -30° / +50°



LED

-  3000K/4000K
-  >150 lm/W
-  CRI > 80
-  Eye safety: RGO/RG1
-  Mac Adams 3
-  L80/B10 >50.000h

CERTIFICATIONS

-  EEA Conformity
-  Energy efficiency
-  5 years warranty

ON REQUEST

-  DALI - code D
-  Bluetooth - code BT*
-  Emergency 1 hr - code EM
Emergency 3 hrs - code EM3H*

SPECIFICATIONS

Built-in driver.
Polycarbonate lens
with concentric undulation.
beam angles: 60° - 110°

BODY

Die-cast aluminum.

COLORS

Black RAL 9005
White RAL 9003 - code B

* Where available

ERGO ESSENTIAL SMALL

Accessories on page 258. **IP 65** **IK10**

Polycarbonate lens. Beam angles: 60° - 110°.

Equipped with 1500mm long cable.

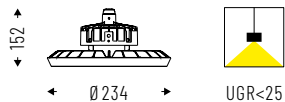

Cod. 4000K	☼	lm	Ø mm
02PC100K460SE	100W 60°	15000	234
02PC100K4110SE	100W 110°	15000	234

Cod. 3000K	☼	lm	Ø mm
02PC100K360SE	100W 60°	14550	234
02PC100K3110SE	100W 110°	14550	234

ERGO ESSENTIAL MEDIUM

Accessories on page 258. **IP 65** **IK10**

Polycarbonate lens. Beam angles: 60° - 110°.

Equipped with 1500mm long cable.

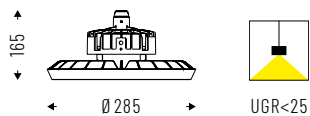

Cod. 4000K	☼	lm	Ø mm
02PC150K460ME	150W 60°	22500	285
02PC150K4110ME	150W 110°	22500	285

Cod. 3000K	☼	lm	Ø mm
02PC150K360ME	150W 60°	21758	285
02PC150K3110ME	150W 110°	21758	285

ERGO ESSENTIAL LARGE

IP 65 IK10

Polycarbonate lens. Beam angles: 60° - 110°.
Equipped with 1500mm long cable.

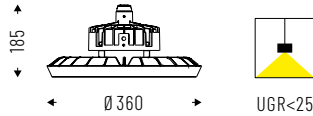

Cod. 4000K		lm	Ø mm
02PC200K460LE	200W 60°	30000	360
02PC200K4110LE	200W 110°	30000	360
02PC240K460LE	240W 60°	31200	360
02PC240K4110LE	240W 110°	31200	360
02PC300K460LE	300W 60°	39000	360
02PC300K4110LE	300W 110°	39000	360

Cod. 3000K		lm	Ø mm
02PC200K360LE	200W 60°	29000	360
02PC200K3110LE	200W 110°	29000	360
02PC240K360LE	240W 60°	30170	360
02PC240K3110LE	240W 110°	30170	360
02PC300K360LE	300W 60°	37713	360
02PC300K3110LE	300W 110°	37713	360

ACCESSORIES



Ring for suspension.

02AA13EGM10 - SMALL / MEDIUM
02AA13EGM12 - LARGE



Safety chain.

02AA13ECS









Bracket for wall / ceiling
installation, inclination $\pm 45^\circ$.

02AA15SME - SMALL / MEDIUM
02AA15LE - LARGE

FEATURES

-  Direct emission
-  UGR <22
-  IP 54
-  IK 10
-  -25° / +35°

LED

-  3000K/4000K
-  >98 lm/W; >103 lm/W
-  CRI >90
-  Eye safety: RG0/RG1
-  Mac Adams 3
-  L80/B10 >50.000h

CERTIFICATIONS

-  EEA Conformity
-  Energy efficiency
-  5 years warranty

ON REQUEST

-  DALI - code D
-  Emergency 1 hr - code EM
Emergency 3 hrs - code EM3H*
-  5000K - code K5*
6500K - code K65*

SPECIFICATIONS

Built-in driver.
Impact resistant polycarbonate diffuser.

BODY

Polycarbonate with high mechanical resistance.
Polyurethane foam seal (PUR)



LINEA IP54

LINEA IP54 is the family of fixtures that **combine efficiency and energy saving** with a long life time. Ideal for laboratories, walking areas and industrial environments.

ID 12



* Where available

arlico

www.arlico.co.uk » +44 (0) 23 8202 2100 » refer to our website for the complete product range

LINEA IP54 ^{LONG}

IP 54 IK10

Impact resistant polycarbonate diffuser.

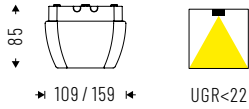

Cod. 4000K	☼	lm	L mm
12P021K454	21W	2130	109x1160
12P025K454	25W	2716	109x1160
12P033K454	33W	3506	109x1160
12P039K454	39W	3971	159x1160
12P048K454	48W	4948	159x1160
12P065K454	65W	6705	159x1160

Cod. 3000K	☼	lm	L mm
12P021K354	21W	1894	109x1160
12P025K354	25W	2255	109x1160
12P033K354	33W	2977	109x1160
12P039K354	39W	3518	159x1160
12P048K354	48W	4330	159x1160
12P065K354	65W	5864	159x1160

LINEA IP54 ^{SQUARE}

IP 54 IK10

Impact resistant polycarbonate diffuser.

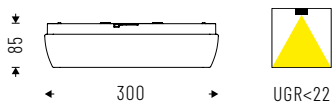

Cod. 4000K	☼	lm	L mm
12P010K454	10W	1097	300
12P013K454	13W	1386	300
12P018K454	18W	1879	300
12P027K454	27W	2688	300

Cod. 3000K	☼	lm	L mm
12P010K354	10W	893	300
12P013K354	13W	1161	300
12P018K354	18W	1607	300
12P027K354	27W	2411	300

LINEA IP54 ROUND

IP 54 IK10

Impact resistant polycarbonate diffuser.

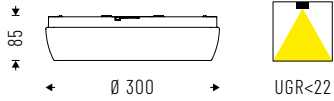

Cod. 4000K	Icon	lm	Ø mm
12P010K454R	10W	1116	300
12P013K454R	13W	1395	300
12P018K454R	18W	1897	300
12P027K454R	27W	2725	300

Cod. 3000K	Icon	lm	Ø mm
12P010K354R	10W	911	300
12P013K354R	13W	1185	300
12P018K354R	18W	1641	300
12P027K354R	27W	2461	300

LINEA IP54 ROUND INTELLIGENT

IP 54 IK10

Impact resistant polycarbonate diffuser. Integrated presence sensor, settable with deepswitch.

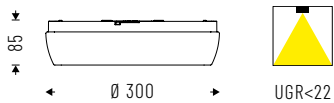

Cod. 4000K	Icon	lm	Ø mm
12P010K454RS	10W	1116	300
12P013K454RS	13W	1395	300

Cod. 3000K	Icon	lm	Ø mm
12P010K354RS	10W	911	300
12P013K354RS	13W	1185	300

INDUSTRIAL IP



PCM EVO

PCM EVO is the **IP66** device that combines **efficiency and energy saving** with an extended life-time. High impact resistance and protection against dust and water.







ID 03



FEATURES

-  Direct emission
-  UGR < 22
-  IP 66
-  IK 10
-  -25° -> +40°/45°
-  850°







LED

-  4000K
-  >100 lm/W; >113 lm/W
-  CRI > 80
-  Eye safety: RG0/RG1
-  Mac Adams 3
-  L80/B10 >50.000h

CERTIFICATIONS

-  EEA Conformity
-  Energy efficiency
-  5 years warranty

ON REQUEST

-  DALI - code D
-  Emergency 1 hr - code EM
Emergency 3 hrs - code EM3H*
-  3000K - code K3
5000K - code K5
6500K - code K65
-  Steel screen holder clips*
-  Built-in sensor*
-  Through wiring*

SPECIFICATIONS

Built-in driver.
UV stabilized translucent polycarbonate screen.
Internal reflector in UV stabilized steel sheet.

BODY

high mechanical resistance
polycarbonate.

* Where available

PCM LED EVO^{PC}

IP 66 IK10

UV stabilized translucent polycarbonate screen.
Internal reflector in sheet steel.

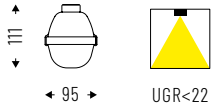

Cod. 4000K		lm	L mm
03PC8K466	8W 4000K IP66	1170	662
03PC10K466	10W 4000K IP66	1410	662
03PC14K466	14W 4000K IP66	1960	662
03PC16K466	16W 4000K IP66	2300	1272
03PC20K466	20W 4000K IP66	2770	1272
03PC27K466	27W 4000K IP66	3870	1272
03PC38K466	38W 4000K IP66	5570	1272
03PC20K4L66	20W 4000K IP66	2880	1572
03PC24K466	24W 4000K IP66	3450	1572
03PC33K466	33W 4000K IP66	4820	1572
03PC45K466	45W 4000K IP66	6890	1572

TECHNICAL NOTES



INDOOR/OUTDOOR INSTALLATION

Not suitable for outdoor applications.
To be installed in indoor or covered outdoor areas.

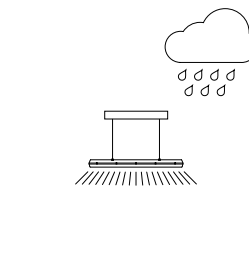
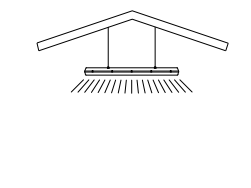
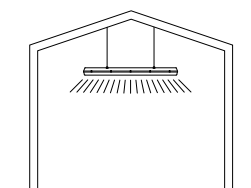





STILLA

STILLA is a **highly technical IP rated fixture** that features performance optics, making it extremely useful for large open plan areas such as **warehousing, transport depots and manufacturing plants**, as well as in **retail applications** that require high brightness artificial lighting with good colour quality. **The body is manufactured from extruded aluminium** for optimum thermal management and it is sealed against moisture and dust ingress to IP65. Dimmable and emergency options are also available, making **STILLA** perfect for use with lighting control systems, where **optimum efficiency and energy savings** are desired.







ID 05



FEATURES

-  Direct emission
-  UGR <22
-  IP 65
-  IK 08
-  -25° / +45°





LED

-  3000K/4000K
- >120 lm/W icon" data-bbox="758 286 788 306"/> >120 lm/W
-  CRI >90
-  Eye safety: R60/R61
-  Mac Adams 3
-  L80/B10 >50.000h

CERTIFICATIONS

-  EEA Conformity
-  Energy efficiency per versione LP - HP
-  Energy efficiency per versione XP
-  5 years warranty

ON REQUEST

-  DALI - code D*
-  Bluetooth - code BT*
-  Emergency 1 hr - code EM
Emergency 3 hrs - code EM3H*
-  5000K - code K5*
-  Through wiring*

SPECIFICATIONS

Built-in driver.
 NB Narrow beam: concentrating polycarbonate lens coextruded in the main diffuser.
 WB Wide beam: diffusing polycarbonate lens coextruded in the main diffuser.
 WO Wide beam opaline lens: diffusing polycarbonate lens coextruded in the main diffuser.
 WA Wide beam acrylic lens: diffusing polycarbonate lens coextruded in the main diffuser.
 Optional: transparent protective glass.

BODY

Aluminum, with die-cast end-caps.

COLORS

Anodized aluminum.

* Where available

STILLA^{NB}

Accessories on page 267. **IP 65** **IK08**

Narrow beam optic, co-extruded into the main diffuser.

Luminaire equipped with 2000mm long cable.

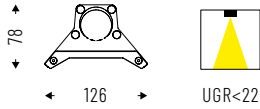

Cod. 4000K	Icon	Im	L mm
05NB24K465	24W	2525	1161
05NB30K465	30W	3157	1441
05NB46K465	46W	4840	1161
05NB57K465	57W	5997	1441
05NB89K465	89W	10243	1161
05NB110K465	110W	12077	1441

Cod. 3000K	Icon	Im	L mm
05NB24K365	24W	2472	1161
05NB30K365	30W	3089	1441
05NB46K365	46W	4738	1161
05NB57K365	57W	5871	1441
05NB89K365	89W	10025	1161
05NB110K365	110W	12073	1441

STILLA^{WB}

Accessories on page 267. **IP 65** **IK08**

Wide beam optic, co-extruded into the main diffuser.

Luminaire equipped with 2000mm long cable.

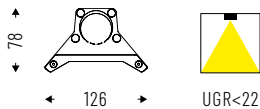

Cod. 4000K	Icon	Im	L mm
05WB24K465	24W	2694	1161
05WB30K465	30W	3367	1441
05WB46K465	46W	5161	1161
05WB57K465	57W	6397	1441
05WB89K465	89W	11158	1161
05WB110K465	110W	13156	1441

Cod. 3000K	Icon	Im	L mm
05WB24K365	24W	2639	1161
05WB30K365	30W	3300	1441
05WB46K365	46W	5060	1161
05WB57K365	57W	6269	1441
05WB89K365	89W	10936	1161
05WB110K365	110W	12893	1441

STILLA^{WO}

IP 65 IK08

Wide beam optic. Frosted polycarbonate lens.

Luminaire equipped with 2000mm long cable.

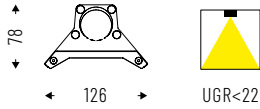

Cod. 4000K	☼	lm	L mm
05W024K465	24W	2407	1161
05W030K465	30W	3010	1441
05W046K465	46W	4615	1161
05W057K465	57W	5718	1441
05W089K465	89W	9486	1161
05W0110K465	110W	11725	1441

Cod. 3000K	☼	lm	L mm
05W024K365	24W	2332	1161
05W030K365	30W	2915	1441
05W046K365	46W	4470	1161
05W057K365	57W	5540	1441
05W089K365	89W	9115	1161
05W0110K365	110W	11265	1441

STILLA^{WA}

IP 65 IK08

Wide beam optic. Acrylic lens.

Luminaire equipped with 2000mm long cable.

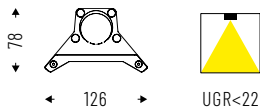

Cod. 4000K	☼	lm	L mm
05WA24K465	24W	2884	1161
05WA30K465	30W	3606	1441
05WA46K465	46W	6021	1161
05WA57K465	57W	7446	1441
05WA89K465	89W	9766	1161
05WA110K465	110W	12070	1441

Cod. 3000K	☼	lm	L mm
05WA24K365	24W	2622	1161
05WA30K365	30W	3281	1441
05WA46K365	46W	5479	1161
05WA57K365	57W	6776	1441
05WA89K365	89W	8887	1161
05WA110K365	110W	10984	1441

ACCESSORIES



Single wire adjustable suspension kit. Length: 1500mm / 3000mm.

05AA13
05AA1330



Spacers kit for ceiling mount.

05AA14



Bracket for continuous rows installation length 1500mm.

05AA11



Brackets kit for wall installation.

05AA15

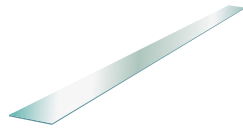

Transparent protective glass.

05AAVTS 1161mm
05AAVTL 1441mm

TECHNICAL NOTES



EXAMPLE OF INSTALLATION IN A CONTINUOUS ROW WITH ACCESSORY 05AA11

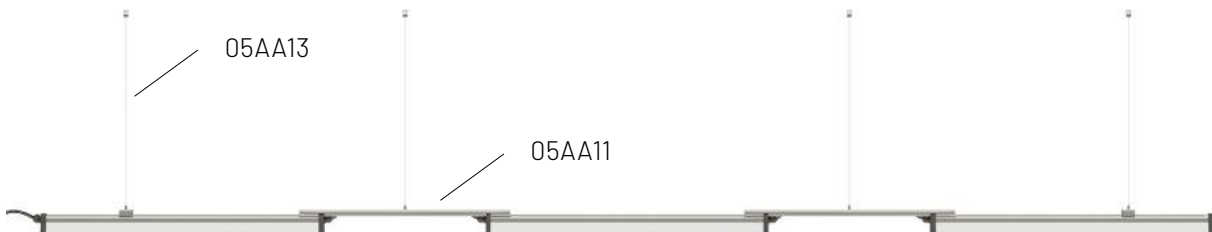

Thanks to the 05AA11 accessory you can install the devices in suspended continuous line by avoiding the use of busbars or cable raceways. This bracket serves as the mechanical joining, allows the masking of the connection cable between 2 devices and reduces the suspension points. It is click fixed on the devices and can be cut at the construction site.





GROOVE IP54

GROOVE IP54 is specifically designed for applications that demand high ingress protection against dust and moisture: it can be installed either as a **single luminaire**, or in **continuous rows**, making it ideal for **industrial and commercial applications**, even in **protected outdoors**. The aluminum body and the flexible diffuser with coextruded gaskets allows designers to freely create stunning solutions, while guaranteeing **maximum performance** and a **high degree of protection**.

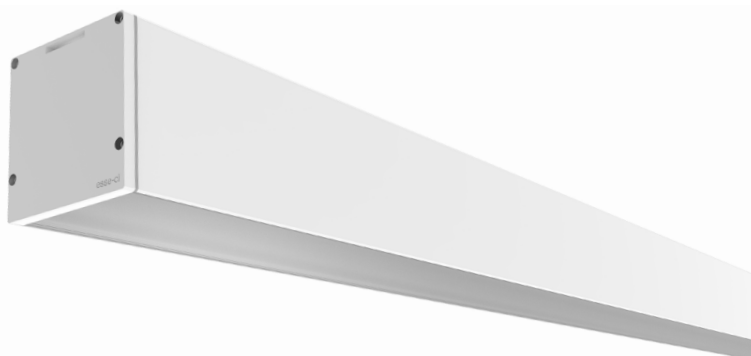





ID 43



FEATURES

-  Direct emission
-  UGR <22
-  IP 54





LED

-  3000K/4000K
-  >90 lm/W; >102 lm/W
-  CRI >90
-  Eye safety: R60/R61
-  Mac Adams 3
-  L80/B10 >50.000h

CERTIFICATIONS

-  EEA Conformity
-  Energy efficiency
-  5 years warranty

ON REQUEST

-  DALI - code D
-  Bluetooth - code BT*
-  Emergency 1 hr - code EM
Emergency 3 hrs - code EM3H*
-  5000K - code K5*

SPECIFICATIONS

Built-in driver.
PG diffuser for homogeneous emission, UGR <22.

BODY ESTRUSO

Aluminum with epoxy powder coating.

COLORS

Matte black RAL 9005 - code C8
Matte white RAL 9003 - code B

RELATED PRODUCTS

Groove (P. 73)
Groove Display (P. 76)
Groove IP54 (P. 268)
Groove Display (P. 271)

* Where available

GROOVE IP54 LOW POWER

Accessories on page 270.

IP 54

Direct emission, ceiling or suspended
 Antistatic satin methacrylate diffuser screen for UGR <22
 homogeneous emission to be ordered separately.
 End-caps not included.

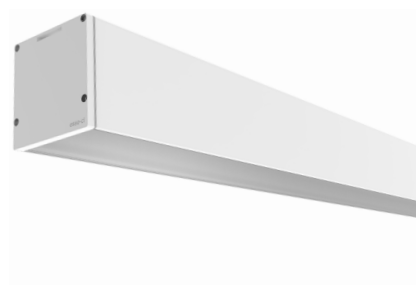
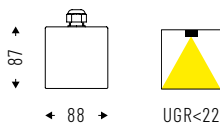

Cod. 4000K	W	lm	L mm
43AA24K454	24W	2558	1130
43AA30K454	30W	3197	1410
43AA36K454	36W	3837	1690
43AA54K454	54W	5755	2530
43AA66K454	66W	7034	3090

Cod. 3000K	W	lm	L mm
43AA24K354	24W	2381	1130
43AA30K354	30W	2977	1410
43AA36K354	36W	3572	1690
43AA54K354	54W	5358	2530
43AA66K354	66W	6549	3090

GROOVE IP54 HIGH POWER

Accessories on page 270.

IP 54

Direct emission, ceiling or suspended
 Antistatic satin methacrylate diffuser screen for UGR <22
 homogeneous emission to be ordered separately.
 End-caps not included.

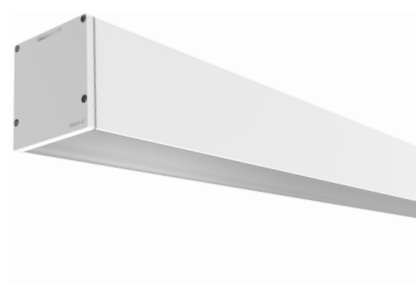
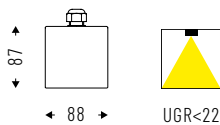

Cod. 4000K	W	lm	L mm
43AA45K4HP54	45W	4706	1130
43AA57K4HP54	57W	5961	1410
43AA68K4HP54	68W	7112	1690

Cod. 3000K	W	lm	L mm
43AA45K3HP54	45W	4381	1130
43AA57K3HP54	57W	5548	1410
43AA68K3HP54	68W	6619	1690

ACCESSORIES



Single wire adjustable suspension kit. 1500mm / 3000mm.

43AA1354
43AA133054



Kit for ceiling mount.

43AA1454



3 - 5 poles ceiling power supply cable. Cable length 2000mm

43AA1654
43AA165P54



End caps kit for suspended and ceiling version.

43AA0954



Linear joint for suspended and ceiling version.

43AA1154



PG screen for single installation.

43PG24 - 24W (LP) / 45W (HP)
43PG30 - 30W (LP) / 57W (HP)
43PG36 - 36W (LP) / 68W (HP)
43PG54 - 54W (LP)
43PG66 - 66W (LP)



Methacrylate satin diffuser UGR<22, 10m coil to be measured and cut on site to provide continuous gap-free light diffusion.

43PG10000

TECHNICAL NOTES





CONTINUOUS ROW INSTALLATION

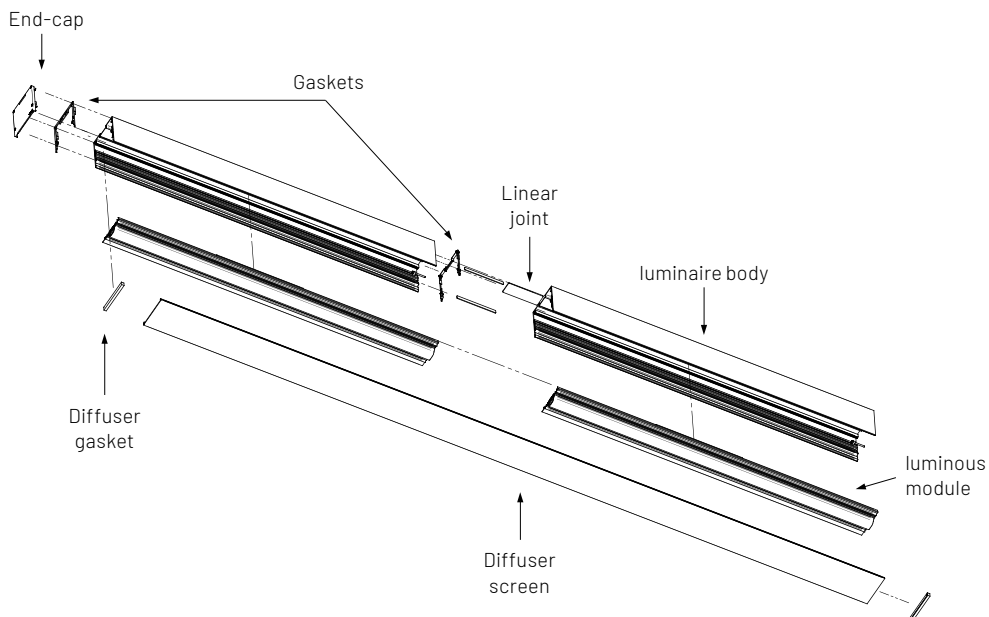





Maximum length of luminaires in continuous line ≤ 10 m.



FEATURES

-  Direct emission
-  UGR <22
-  IP 54





LED

-  3000K/4000K
-  >102 lm/W
-  CRI >90
-  Eye safety: R60/R61
-  Mac Adams 3
-  L80/B10 >50.000h

CERTIFICATIONS

-  EEA Conformity
-  Energy efficiency
-  5 years warranty

ON REQUEST

-  DALI - code D
-  Bluetooth - code BT*
-  Emergency 1 hr - code EM
Emergency 3 hrs - code EM3H*
-  2700K - code K27*
5000K - code K5*

SPECIFICATIONS

Built-in driver.
Diffuser in antistatic satin methacrylate, for homogeneous emission UGR <22.

BODY

Aluminum with epoxy powder coating.

COLORS

Matte white RAL 9003 - code B
Matte black RAL 9005 - code C8

RELATED PRODUCTS

Groove (P. 33)
Groove Display (P. 76)
Groove IP54 (P. 268)
Groove Display IP54 (P. 271)

* Where available



GROOVE DISPLAY IP54 is designed specifically for **recessed applications** that demand **high ingress protection** against dust and moisture. Perfectly complementing the interior GROOVE collection, it can be installed either as a **single luminaire or in continuous rows**, allowing designers to freely create stunning solutions. The aluminum body and the flexible diffuser with coextruded gaskets guarantee **maximum performance**, achieving an **IP54 protection rating**, making the collection ideal for **industrial and commercial applications**, even in protected outdoors.

ID 43



GROOVE DISPLAY IP54 LOW POWER

IP 54

Direct recessed emission.

Antistatic satin methacrylate diffuser screen for UGR <22
homogeneous emission to be ordered separately.
End-caps not included.

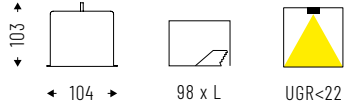

Cod. 4000K	W	lm	L mm
43AA24K4F54	24W	2558	1130
43AA30K4F54	30W	3197	1410
43AA36K4F54	36W	3837	1690
43AA42K4F54	42W	4476	1970
43AA48K4F54	48W	5116	2250
43AA54K4F54	54W	5755	2530
43AA60K4F54	60W	6395	2810
43AA66K4F54	66W	7034	3090

Cod. 3000K	W	lm	L mm
43AA24K3F54	24W	2381	1130
43AA30K3F54	30W	2977	1410
43AA36K3F54	36W	3572	1690
43AA42K3F54	42W	4167	1970
43AA48K3F54	48W	4763	2250
43AA54K3F54	54W	5358	2530
43AA60K3F54	60W	5954	2810
43AA66K3F54	66W	6549	3090

GROOVE DISPLAY IP54 HIGH POWER

IP 54

Direct recessed emission.

Antistatic satin methacrylate diffuser screen for UGR <22
homogeneous emission to be ordered separately.
End-caps not included.



Cod. 4000K	W	lm	L mm
43AA45K4HPF54	45W	4706	1130
43AA57K4HPF54	57W	5961	1410
43AA68K4HPF54	68W	7112	1690

Cod. 3000K	W	lm	L mm
43AA45K3HPF54	45W	4381	1130
43AA57K3HPF54	57W	5548	1410
43AA68K3HPF54	68W	6619	1690

ACCESSORIES



End caps kit.
(Consider + 15 mm on
the cutting length).

43AA09F54



PG screen for single
installation.

43PG24 - 24W (LP) / 45W (HP)
43PG30 - 30W (LP) / 57W (HP)
43PG36 - 36W (LP) / 68W (HP)
43PG42 - 42W (LP)
43PG48 - 48W (LP)
43PG54 - 54W (LP)
43PG60 - 60W (LP)
43PG66 - 66W (LP)



Methacrylate satin diffuser
UGR<22, 10m coil to be
measured and cut on site to
provide continuous gap-free
light diffusion.

43PG10000



Linear joint with gasket.
(Consider + 4 mm on
the cutting length)

43AA11F54



MEDICAL

Isib Led IP54 **276** ID34



Isi Led IP55 **278** ID31



Isi Led IP65 **280** ID31



Arkeon Med **282** ID46



C
H
A
P
T
E
R

T
E
N

MEDICAL





ISIB LED IP54

ISIB LED IP54 fixtures with **back light LED technology** are the perfect mix between **competitiveness, performance and flexibility**. **Perfect homogeneous emission** thanks to the frosted or microprismatic diffuser. The IP54 rating make it also suitable for environments where a **high degree of protection** is required. Ideal for false ceilings with exposed structure, **ISIB LED IP54** can be installed also on plasterboard thanks to the dedicated accessory.

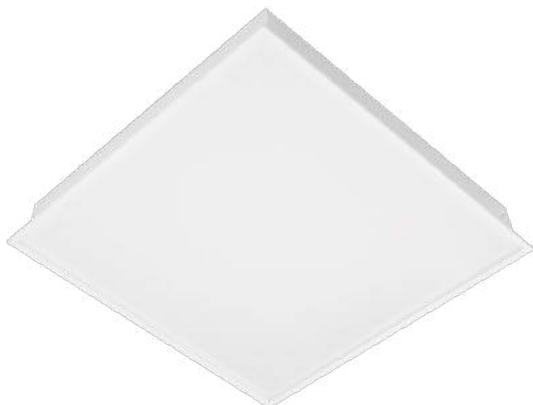





ID 34



FEATURES

-  Direct emission
-  UGR <22; <19
-  IP 54 (frontalmente)







LED

-  3000K/4000K
-  >112 lm/W
-  CRI >90
-  Eye safety: R60/R61
-  Mac Adams 3
-  L80/B10 >50.000h

CERTIFICATIONS

-  EEA Conformity
-  Energy efficiency
-  5 years warranty

ON REQUEST

-  DALI - code D
-  Bluetooth - code BT*
-  Emergency 1 hr - code EM
Emergency 3 hrs - code EM3H*
-  False ceiling version
625x625mm*
-  Ceiling mount
installation kit*
-  5000K - code K5*

SPECIFICATIONS

Built-in driver.
Quick connector for easy wiring.
High homogeneity satin acrylic diffuser glued to the body, UGR <22.
Additional microprismatic plate applied on the structure, UGR <19.

BODY

Steel sheet with with epoxy powder coating.

COLORS

White RAL 9003

* Where available

ISIB LED IP54^{PG}

IP 54

Frosted high homogeneity acrylic diffuser glued to the body, UGR<22.

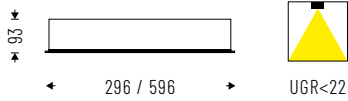

Cod. 4000K	W	lm	L mm
34PG34K454	34W	3952	596x596
34PG55K454	55W	6175	596x596
34PG34K4M354	34W	3952	296x1196

Cod. 3000K	W	lm	L mm
34PG34K354	34W	3786	596x596
34PG55K354	55W	5558	596x596
34PG34K3M354	34W	3786	296x1196

ACCESSORIES



Microprismatic plate (UGR <19) for mounting on ceiling module 600 with visible structure.

LMISIMP3454 594x594mm
LMISIMP34M354 294x1194mm

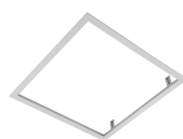

Plasterboard installation frame.

FCG3454 600x600mm
FCG34M354 300x1200mm





ISI LED IP55

ISI LED IP55 is designed **for sterile environments:** a universal LED technology fixture **for false ceiling with visible and hidden structure.**







ID 31



FEATURES

-  Direct emission
-  UGR <19; <22
-  IP 55





LED

-  3000K/4000K
-  >106 lm/W
-  CRI >90
-  Eye safety: R60/R61
-  Mac Adams 3
-  L80/B10 >50.000h

CERTIFICATIONS

-  EEA Conformity
-  Energy efficiency
-  5 years warranty

ON REQUEST

-  DALI - code D
-  Emergency 1 hr - code EM
Emergency 3 hrs - code EM3H*
-  5000K - code K5*
-  Ceiling version*
-  False ceiling version
625x625mm*

SPECIFICATIONS

Built-in driver.
Fixed power current driver.
Nominal life span 50.000h.
(T° max. 50 °C / failure rate ≤ 0.2% per 1,000 h).
Quick connector supplied as standard.
DPL with internal microprismatic plate, UGR <19.
PG with PMMA diffuser for homogeneous emission, UGR <22.

BODY

Extruded aluminum frame.
Steel sheet with epoxy powder coating.

COLORS

White RAL 9003

* Where available

ISI LED IP55^{DPL}

IP 55

DPL technology with UGR<19 composed by a microprismatic internal sheet.

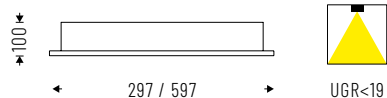

Cod. 4000K	W	lm	L mm
31DPL38K455	38W	3357	597x597
31DPL64K455	64W	6547	597x597
31DPL38K455M3	38W	3357	297x1197
31DPL64K455M3	64W	6547	297x1197

Cod. 3000K	W	lm	L mm
31DPL38K355	38W	3181	597x597
31DPL64K355	64W	5952	597x597
31DPL38K355M3	38W	3181	297x1197
31DPL64K355M3	64W	5952	297x1197

ISI LED IP55^{PG}

IP 55

PMMA diffuser for homogeneous emission, UGR<22.

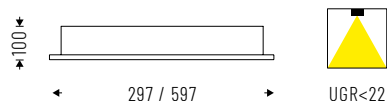

Cod. 4000K	W	lm	L mm
31PG38K455	38W	3428	597x597
31PG64K455	64W	6845	597x597
31PG38K455M3	38W	3428	297x1197
31PG64K455M3	64W	6845	297x1197

Cod. 3000K	W	lm	L mm
31PG38K355	38W	3251	597x597
31PG64K355	64W	6250	597x597
31PG38K355M3	38W	3251	297x1197
31PG64K355M3	64W	6250	297x1197

ACCESSORIES



Kit of fixing brackets for installation on plasterboard, with hidden structure and on slats.

KSFDP65





ISI LED IP65

ISI LED IP65 is designed for **sterile environments**: a universal LED technology fixture for **false ceiling with visible and hidden structure**.







ID 31



FEATURES

-  Direct emission
-  UGR <19; <22
-  IP 65





LED

-  3000K/4000K
-  >104 lm/W
-  CRI >90
-  Eye safety: R60/R61
-  Mac Adams 3
-  L80/B10 >50.000h

CERTIFICATIONS

-  EEA Conformity
-  Energy efficiency
-  5 years warranty

ON REQUEST

-  DALI - code D
-  Emergency 1 hr - code EM
Emergency 3 hrs - code EM3H*
-  5000K - code K5*
-  Ceiling version*
-  False ceiling version
625x625mm*

SPECIFICATIONS

Built-in driver.
Fixed power current driver.
Nominal life span 50.000h.
(T° max. 50 °C / failure rate ≤ 0.2% per 1,000 h).
Quick connector supplied as standard.
VDPL with internally prismatic diffuser, UGR <19.
VG with frosted glass diffuser for homogeneous emission, UGR <22.

BODY

Extruded aluminum frame.
Steel sheet with epoxy powder coating.

COLORS

White RAL 9003

* Where available

ISI LED IP65^{VDPL}

IP 65

VDPL technology with UGR<19 composed by a microprismatic internal sheet and a transparent protective glass.

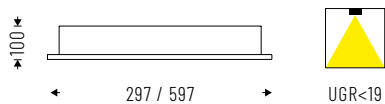

Cod. 4000K	Icon	lm	L mm
31VDPL38K465	38W	3341	597x597
31VDPL64K465	64W	6130	597x597
31VDPL38K465M3	38W	3341	297x1197
31VDPL64K465M3	64W	6130	297x1197

Cod. 3000K	Icon	lm	L mm
31VDPL38K365	38W	3132	597x597
31VDPL64K365	64W	5833	597x597
31VDPL38K365M3	38W	3132	297x1197
31VDPL64K365M3	64W	5833	297x1197

ISI LED IP65^{VG}

IP 65

Frosted tempered anti-glare glass, UGR<22.

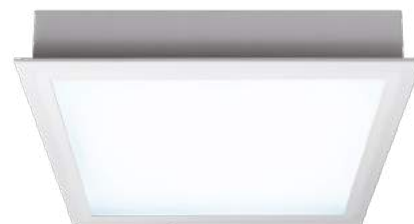
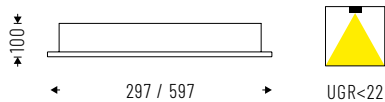

Cod. 4000K	Icon	lm	L mm
31VG38K465	38W	3393	597x597
31VG64K465	64W	6670	597x597
31VG38K465M3	38W	3393	297x1197
31VG64K465M3	64W	6670	297x1197

Cod. 3000K	Icon	lm	L mm
31VG38K365	38W	3177	597x597
31VG64K365	64W	6071	597x597
31VG38K365M3	38W	3177	297x1197
31VG64K365M3	64W	6071	297x1197

ACCESSORIES



Kit of fixing brackets for installation on plasterboard, with hidden structure and on slats.

KSFDP65



ARKEON MED

ARKEON MED is the new bed-head unit developed by Esse-Ci to meet the lighting and functional needs of **hospital or care facilities**. Thanks to the use of the latest generation components **ARKEON MED** guarantees **efficiency and reliability** and integrates perfectly into the spaces with a simple and linear design, ideal for easy cleaning. The control devices are **ergonomic and easily accessible** and the **great versatility** of the product makes it **suitable for all healthcare applications**.







ID 46



FEATURES

-  Direct emission
-  Direct/Indirect emission
-  Emissione per lettura
-  UGR <22
-  IP 40

LED

-  3000K/4000K
-  >116 lm/W
-  CRI >90
-  Eye safety: RGO/RG1
-  Mac Adams 3
-  L80/B10 >50.000h

CERTIFICATIONS

-  EEA Conformity
-  Energy efficiency
-  5 years warranty

ON REQUEST

-  DALI - code D*
-  Emergency 1 hr - code EM*
Emergency 3 hrs - code EM3H*
-  2700K - code K27*
6500K - code K65*
-  HCL Human Centric Lighting*

SPECIFICATIONS

Built-in driver.
24V IP67 keypad with 2m cable and anti-tear system, positioned on the right or left side.
1 socket (2Poles + ground) 16A.
Asymmetrical polycarbonate lens for direct emission.
Satin diffuser UGR <22 for indirect emission.

BODY

Extruded aluminum with epoxy powder coating.

COLORS

Matte white RAL 9003 - code B

RELATED PRODUCTS

Arkeon (P. 17)
Arkeon Wall (P. 247)

ARKEON HIGH OUTPUT CLD DOUBLE EMISSION

IP 40

Device complete with 24V control panel with 2 buttons (reading light, nurse call), 2000mm cable and tear-proof system, 1 socket 2E+ T 10/16A. Available in right (DX) or left (SX) socket versions.

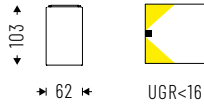

Cod. 4000K	Icon	lm	L mm
46DI44K42PP1PDX		44W: 14W+30W	4620 998
46DI44K42PP1PSX		44W: 14W+30W	4620 998
46DI59K42PP1PDX		59W: 19W+40W	6195 1278
46DI59K42PP1PSX		59W: 19W+40W	6195 1278

Cod. 3000K	Icon	lm	L mm
46DI44K32PP1PDX		44W: 14W+30W	4532 998
46DI44K32PP1PSX		44W: 14W+30W	4532 998
46DI59K32PP1PDX		59W: 19W+40W	6077 1278
46DI59K32PP1PSX		59W: 19W+40W	6077 1278

ARKEON MED FREE

In its FREE version, ARKEON MED meets the most varied customization needs, offering countless configuration possibilities, adapting to different design and functional needs.

LED MODULES AND OPTICS

BLIND MODULES

BODY
Pre-wired aluminum body, available lengths from 900mm to 4000mm. Standard colors: black, white - customizable on request.

COMMANDS

MODULES

OPTICS

SOCKET / SWITCHES

BLIND MODULES
Blind module in painted roll adaptable to size on site.

DIRECT LED MODULE
Direct light LED module with asymmetrical optics, 3000K / 4000K / HCL.

INDIRECT LED MODULE
Indirect light led module with soft light diffuser 3000K / 4000K / HCL (reading/general).

SPOT LED MODULE
Spot module with adjustable beam lens from 10° to 40°.

SOCKET / SWITCHES
Bypass socket 2P+E 10/16A
Universal socket - USB socket.
Switch - Two-pole switch
Push button.

COMMAND
Tie rod for assistance call.

COMMAND
24V control panel with 2/3 buttons (reading light, direct light, assistance call) with L2000mm cable.

APP
BT system for management with free App.

MEDICAL



TYPE OF LIGHTING



ALL ON MODE

- indirect environmental emission
- direct asymmetric emission

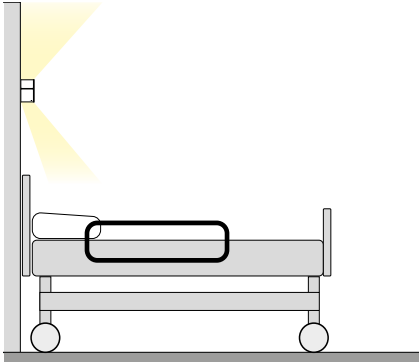

VISIT MODE

- direct asymmetric emission

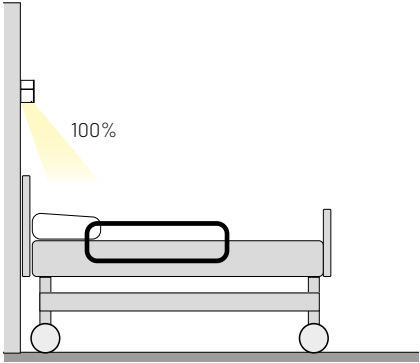

READING MODE

- partial direct asymmetric emission

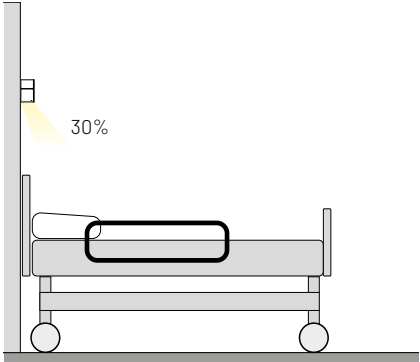

TECHNICAL NOTES



ARKEON MED FREE CONFIGURATION

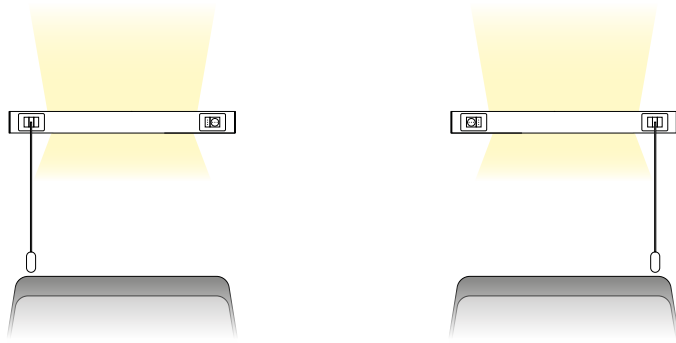

- Configuration with distinct elements.

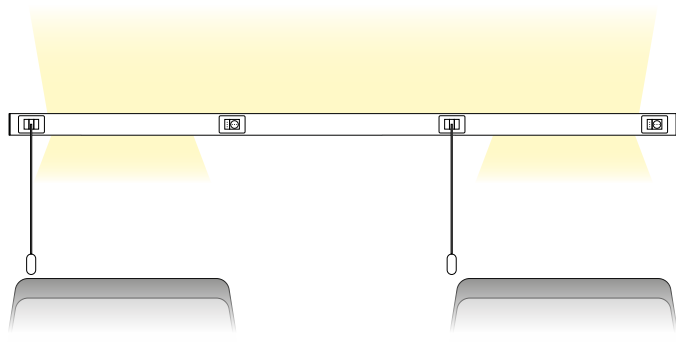

- Configuration with single element.
- 4m length.
- Seamless indirect emission.

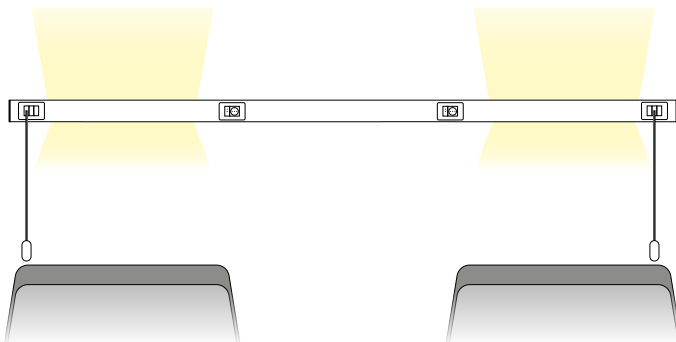

- Configuration with single element.
- 4m length.
- Separate indirect emission.



24V CONTROL PANEL .





UNIVERSAL SOCKET
+ USB SOCKET.

MEDICAL



EMERGENCY

Rem Track	288	ID13	
Rem Ceiling Evo	288	ID13	
Rem Recessed	288	ID13	

C
H
A
P
T
E
R

E
L
E
V
E
N



REM is a range of **emergency fixtures with integrated driver and batteries up to 3-hour configurations**. Mounting options include **recessed installation, ceiling** and for Esse-ci **three-phase track**. The luminaires are equipped with 3 different types of lens, for anti-panic lighting, escape route or with an arrow beam for high ceiling applications.





ID 13



FEATURES

-  Direct emission
-  IP 20 / IP 40



LED

-  6500K
- >109 lm/W icon" data-bbox="758 207 788 227"/> >109 lm/W
-  CRI >80
-  Eye safety: RGO/RG1
-  Mac Adams 3
-  L80/B10 >50.000h

CERTIFICATIONS

-  EEA Conformity
-  5 years warranty

ON REQUEST

-  Always ON version
-  Self-test

SPECIFICATIONS

Integrated driver and accumulator.
Spot / Escape routes / Anti-panic.

BODY

Polycarbonate

COLORS

White RAL 9003 - code B
Black RAL 9005 - code C8

REM TRACK

IP 40

With Eutrack adaptor. 3 hours autonomy.
With S/E mode (emergency only).

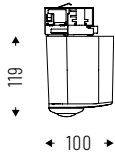

Cod. 6500K		lm	L mm
13EM2K65H3	2W	217	110x56

REM CEILING EVO

IP 40

For direct ceiling mount. 3 hours autonomy.
With S/E mode (emergency only).

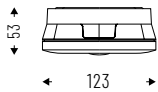

Cod. 6500K		lm	L mm
13EM2K65H3CE	2W	217	123x123

REM RECESSED

IP 20

For recessed mount. 3 hours autonomy.
With S/E mode (emergency only).

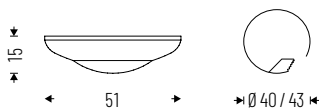

Cod. 6500K		lm	Ø mm
13EM2K65H3R	2W	217	51

EMERGENCY

TECHNICAL NOTES



REM CONFIGURATIONS

Spot

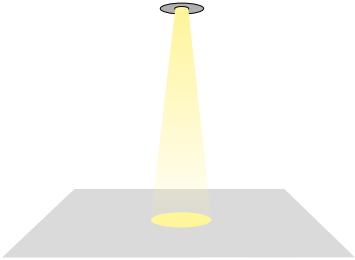

Escape routes

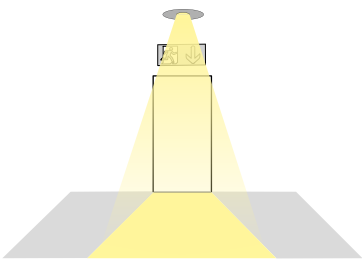

Anti-panic

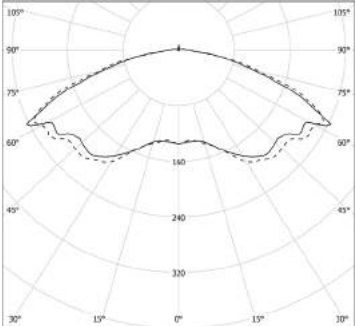
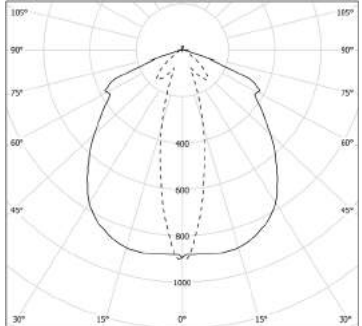
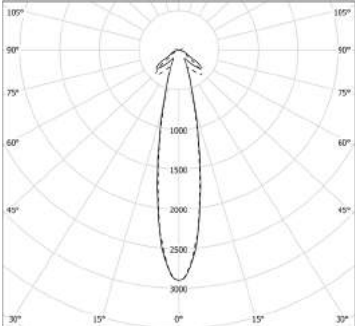
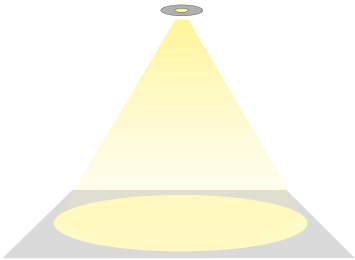



C
H
A
P
T
E
R

T
W
E
L
V
E

OUTDOOR IP

Hall Led IP65	292	ID38
Hall Led Ceiling IP65	297	ID28
Hall Led Ground	300	ID38
Walkabout	305	ID93
Teres IP66	309	ID14
Moon	312	ID51
Ben IP54	315	ID10
Gleis	318	ID61
Nobis	320	ID90
Scout	324	ID91
Magis Flood	327	ID92

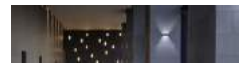



HALL LED IP65

HALL LED IP65 is a series of **outdoor LED downlights** for functional and architectural lighting, which puts structures in the foreground while staying behind the scenes: thanks to the **built-in driver**, it always manages to offer elegant and compact solutions.







ID 38



FEATURES

-  Direct emission
-  UGR <19
-  IP 65
-  IK 02; 06; 10
-  -20° / +40°



LED

-  3000K/4000K
-  >90 lm/W; >126 lm/W
-  CRI >90
-  Eye safety: RGO/RG1
-  Mac Adams 3
-  L80/B10 >50.000h

CERTIFICATIONS

-  EEA Conformity
-  Energy efficiency
-  5 years warranty

ON REQUEST

-  DALI - code D*
-  Emergency 1 hr - code EM*
Emergency 3 hrs - code EM3H*
-  5000K - code K5*

SPECIFICATIONS

Built-in driver.
CoB LED technology.
EASY: internal aluminum reflectors with emissions: 15°- 24°- 36°- 50°.
MEDIUM and LARGE: internal reflectors aluminum with emissions: 10°- 12°- 20°- 40°- 70°.
Accent Light: concentrated beam.
High Wallwasher.
Wide Wallwasher.

BODY

Die-cast aluminum.

COLORS

White RAL 9003 wrinkled - code B
Black RAL 9005 wrinkled - code C8

* Where available

HALL LED IP65 ^{EASY}

Accessories on page 296.  **IP65 IK02**

Internal aluminum reflectors.
Beam angles: 15°- 24°- 36°- 50°.
CUT OFF > 30°.

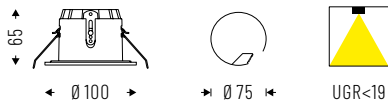

Cod. 4000K		lm	Ø mm
38VT6K415E65	6W 15°	599	100
38VT6K424E65	6W 24°	599	100
38VT6K436E65	6W 36°	599	100
38VT6K450E65	6W 50°	599	100

Cod. 3000K		lm	Ø mm
38VT6K315E65	6W 15°	579	100
38VT6K324E65	6W 24°	579	100
38VT6K336E65	6W 36°	579	100
38VT6K350E65	6W 50°	579	100

HALL LED IP65 ^{MEDIUM}

Accessories on page 296.  **IP65 IK06**

Internal aluminum reflectors.
Beam angles: 10°- 20°- 40°- 70°.
CUT OFF > 30°.



Cod. 4000K		lm	Ø mm
38VT7K410M65	7W 10°	655	165
38VT7K420M65	7W 20°	655	165
38VT7K440M65	7W 40°	655	165
38VT7K470M65	7W 70°	655	165
38VT18K410M65	18W 10°	1595	165
38VT18K420M65	18W 20°	1595	165
38VT18K440M65	18W 40°	1595	165
38VT18K470M65	18W 70°	1595	165

Cod. 3000K		lm	Ø mm
38VT7K310M65	7W 10°	627	165
38VT7K320M65	7W 20°	627	165
38VT7K340M65	7W 40°	627	165
38VT7K370M65	7W 70°	627	165
38VT18K310M65	18W 10°	1529	165
38VT18K320M65	18W 20°	1529	165
38VT18K340M65	18W 40°	1529	165
38VT18K370M65	18W 70°	1529	165

HALL LED IP65 MEDIUM ACCENT LIGHT

Accessories on page 296. **IP65** **IK10**

AL - Accent light (concentrating beam).
Transparent glass with internal aluminum reflectors.
Beam angles: 25°- 45°- 60°- 80°.
CUT OFF > 30°.



Cod. 4000K	☼	lm	Ø mm
38AL13K425M65	13W 25°	1326	150
38AL13K445M65	13W 45°	1326	150
38AL13K460M65	13W 60°	1326	150
38AL13K480M65	13W 80°	1326	150

Cod. 3000K	☼	lm	Ø mm
38AL13K325M65	13W 25°	1207	150
38AL13K345M65	13W 45°	1207	150
38AL13K360M65	13W 60°	1207	150
38AL13K380M65	13W 80°	1207	150

HALL LED IP65 MEDIUM HIGH WALLWASHER

Accessories on page 296. **IP65** **IK10**

HW - High wallwasher.
Transparent glass with high asymmetric lens.
CUT OFF > 30°.



Cod. 4000K	☼	lm	Ø mm
38HA13K4M65	13W	1326	150

Cod. 3000K	☼	lm	Ø mm
38HA13K3M65	13W	1207	150

HALL LED IP65 MEDIUM WIDE WALLWASHER

Accessories on page 296. **IP65** **IK10**

WW - Wide wallwasher.

Transparent glass with wide beam asymmetric lens.
CUT OFF > 30°.



Cod. 4000K	☼	lm	Ø mm
38WA13K4M65	13W	1326	150

Cod. 3000K	☼	lm	Ø mm
38WA13K3M65	13W	1207	150

HALL LED IP65 LARGE

Accessories on page 296. **IP65** **IK06**

Internal aluminum reflectors:
Beam angles: 12°- 20°- 40°- 70°.
CUT OFF > 30°.

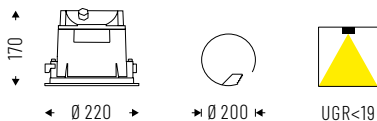

Cod. 4000K	☼	lm	Ø mm
38VT18K412L65	18W 12°	2316	220
38VT18K420L65	18W 20°	2316	220
38VT18K440L65	18W 40°	2316	220
38VT18K470L65	18W 70°	2316	220
38VT25K412L65	25W 12°	3151	220
38VT25K420L65	25W 20°	3151	220
38VT25K440L65	25W 40°	3151	220
38VT25K470L65	25W 70°	3151	220

Cod. 3000K	☼	lm	Ø mm
38VT18K312L65	18W 12°	2240	220
38VT18K320L65	18W 20°	2240	220
38VT18K340L65	18W 40°	2240	220
38VT18K370L65	18W 70°	2240	220
38VT25K312L65	25W 12°	3048	220
38VT25K320L65	25W 20°	3048	220
38VT25K340L65	25W 40°	3048	220
38VT25K370L65	25W 70°	3048	220

ACCESSORIES



HALL LED IP65 MEDIUM
Box for recessed
installation on concrete.

38AABCM



HALL LED IP65 LARGE
Box for recessed
installation on concrete.

38AABCL

TECHNICAL NOTES



**HALL IP65 MEDIUM
ACCENT LIGHT**

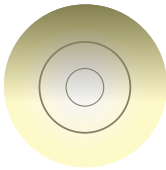

**HALL IP65 MEDIUM
HIGH WALLWASHER**



**HALL IP65 MEDIUM
WIDE WALLWASHER**

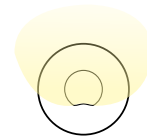



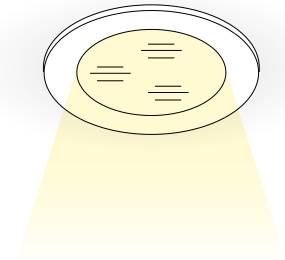
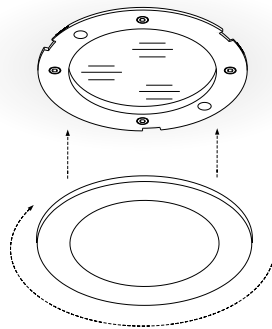
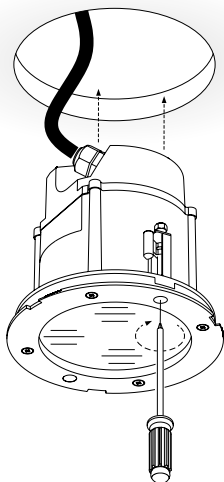

INSTALLATION



FEATURES

-  Direct emission
-  UGR < 22
-  IP 65
-  IK 06

LED

-  3000K/4000K
- >125 lm/W icon" data-bbox="70 261 98 281"/> >125 lm/W
-  CRI > 90
-  Eye safety: R60/R61
-  Mac Adams 3
-  L80/B10 > 50.000h

CERTIFICATIONS

-  EEA Conformity
-  Energy efficiency
-  5 years warranty

ON REQUEST

-  DALI - code D*
-  2700K - code K27*
-  5000K - code K5*
-  MINI version: Ø60mm*

SPECIFICATIONS

LED CoB technology.
Built-in driver.
SMALL: internal aluminum reflectors
beam angles: 10°- 20°- 40°- 50°.
MEDIUM and LARGE:
internal reflectors aluminum with
beam angles: 10°- 12°- 20°- 40°- 70°.

BODY

Die-cast aluminum.

COLORS

White RAL 9003 wrinkled - code W
Black RAL 9005 wrinkled - code BK

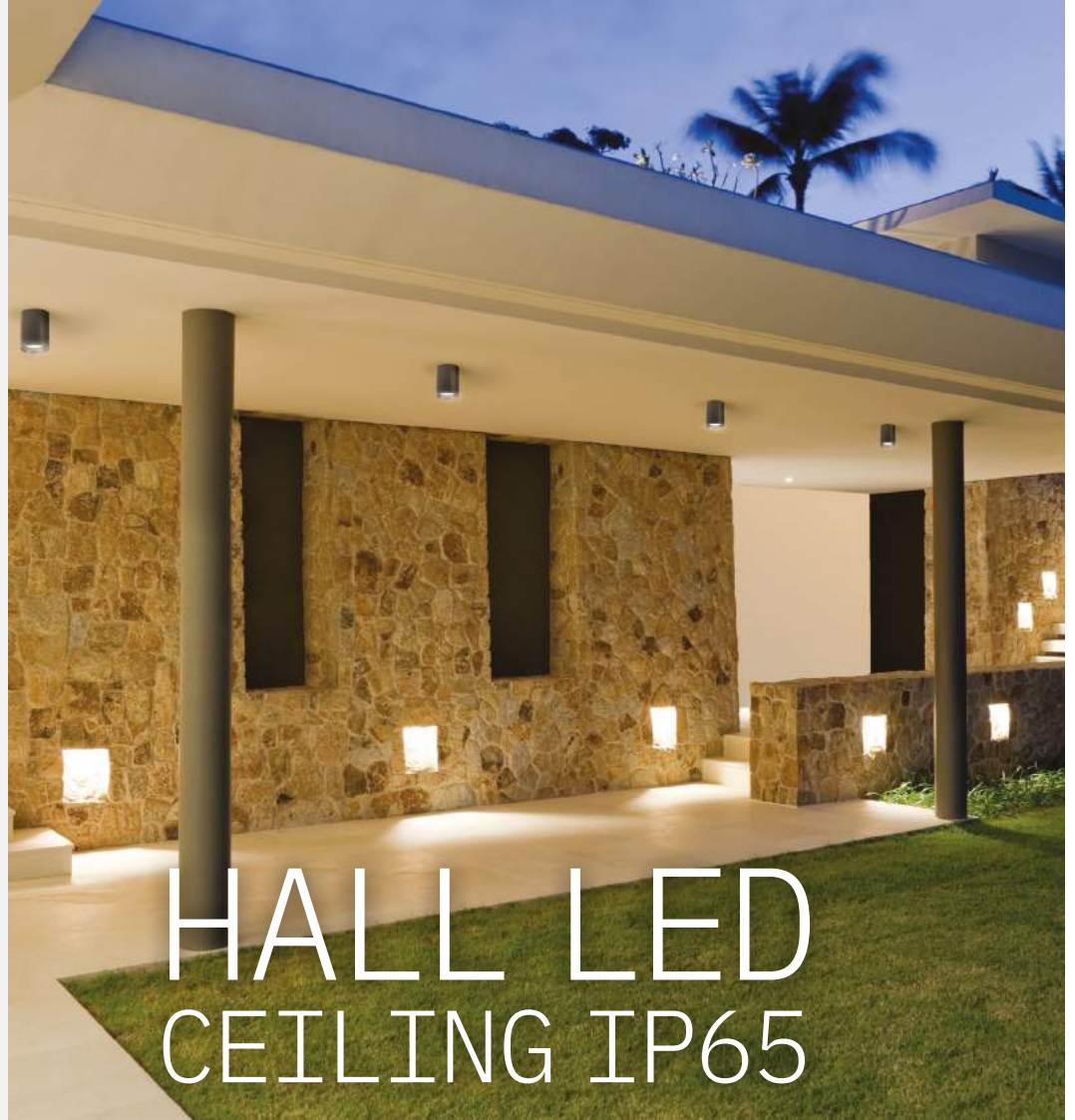

HALL LED CEILING IP65

HALL LED CEILING IP65 extends HALL collection for external use with a high performance downlight, characterized by a minimal die-cast aluminum housing in a durable matt textured power coated finish. As standard the range features **integrated drivers** making the product both **simple to install and compact in size**. The high ingress protection rating of IP65 makes this an ideal product for any wet area application including the **outdoor environment**.

ID 28



OUTDOOR IP

*Verificata diennihilità

arlico

www.arlico.co.uk » +44 (0) 23 8202 2100 » refer to our website for the complete product range

HALL LED CEILING IP65 SMALL

IP65 IK06

Internal aluminum reflectors:
Beam angles: 10°- 20°- 40° - 50°.
CUT OFF >30°.

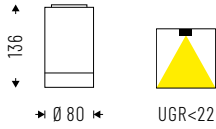

Cod. 4000K	☼	lm	Ø mm
28VT13K410S65	13W 10°	1152	80
28VT13K420S65	13W 20°	1152	80
28VT13K440S65	13W 40°	1152	80
28VT13K450S65	13W 50°	1152	80
28VT18K410S65	18W 10°	1595	80
28VT18K420S65	18W 20°	1595	80
28VT18K440S65	18W 40°	1595	80
28VT18K450S65	18W 50°	1595	80

Cod. 3000K	☼	lm	Ø mm
28VT13K310S65	13W 10°	1104	80
28VT13K320S65	13W 20°	1104	80
28VT13K340S65	13W 40°	1104	80
28VT13K350S65	13W 50°	1104	80
28VT18K310S65	18W 10°	1529	80
28VT18K320S65	18W 20°	1529	80
28VT18K340S65	18W 40°	1529	80
28VT18K350S65	18W 50°	1529	80

HALL LED CEILING IP65 MEDIUM

IP65 IK06

Internal aluminum reflectors:
Beam angles: 10°- 20°- 40° - 70°.
CUT OFF >30°.

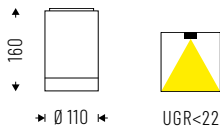

Cod. 4000K	☼	lm	Ø mm
28VT18K410M65	18W 10°	2316	110
28VT18K420M65	18W 20°	2316	110
28VT18K440M65	18W 40°	2316	110
28VT18K470M65	18W 70°	2316	110
28VT25K410M65	25W 10°	3151	110
28VT25K420M65	25W 20°	3151	110
28VT25K440M65	25W 40°	3151	110
28VT25K470M65	25W 70°	3151	110

Cod. 3000K	☼	lm	Ø mm
28VT18K310M65	18W 10°	2154	110
28VT18K320M65	18W 20°	2154	110
28VT18K340M65	18W 40°	2154	110
28VT18K370M65	18W 70°	2154	110
28VT25K310M65	25W 10°	2930	110
28VT25K320M65	25W 20°	2930	110
28VT25K340M65	25W 40°	2930	110
28VT25K370M65	25W 70°	2930	110

HALL LED CEILING IP65 LARGE

IP65 IK06

Internal aluminum reflectors:
 Beam angles: 12°- 20°- 40° - 70°.
 CUT OFF > 30°.

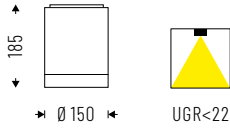

Cod. 4000K	☼	lm	Ø mm
28VT35K412L65	35W 12°	4029	150
28VT35K420L65	35W 20°	4029	150
28VT35K440L65	35W 40°	4029	150
28VT35K470L65	35W 70°	4029	150
28VT38K412L65	38W 12°	4214	150
28VT38K420L65	38W 20°	4214	150
28VT38K440L65	38W 40°	4214	150
28VT38K470L65	38W 70°	4214	150
28VT52K412L65	52W 12°	5647	150
28VT52K420L65	52W 20°	5647	150
28VT52K440L65	52W 40°	5647	150
28VT52K470L65	52W 70°	5647	150

Cod. 3000K	☼	lm	Ø mm
28VT35K312L65	35W 12°	3624	150
28VT35K320L65	35W 20°	3624	150
28VT35K340L65	35W 40°	3624	150
28VT35K370L65	35W 70°	3624	150
28VT38K312L65	38W 12°	3813	150
28VT38K320L65	38W 20°	3813	150
28VT38K340L65	38W 40°	3813	150
28VT38K370L65	38W 70°	3813	150
28VT52K312L65	52W 12°	5109	150
28VT52K320L65	52W 20°	5109	150
28VT52K340L65	52W 40°	5109	150
28VT52K370L65	52W 70°	5109	150

TECHNICAL NOTES



INSTALLATION

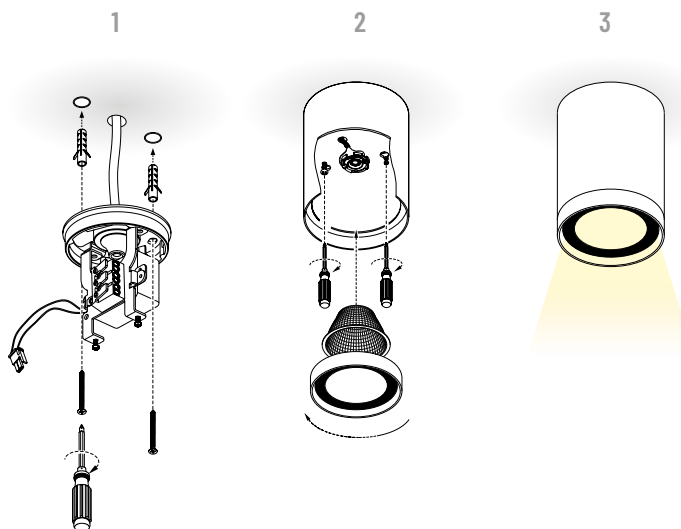







HALL LED GROUND

The **HALL LED** family expands with the **GROUND** version, suitable for **recessed ground installation** to illuminate passageways or green areas.







ID 38



FEATURES

-  UGR <22
-  IP 67
-  IK 10
-  -20°C / +40°C
-  20 KN



LED

-  3000K
-  >115 lm/W
-  CRI >80
-  Eye safety: RG0/RG1
-  Mac Adams 3
-  L80/B10 >50.000h

CERTIFICATIONS

-  EEA Conformity
-  Energy efficiency
-  5 years warranty

ON REQUEST

-  DALI - code D*
-  4000K - code K4*

SPECIFICATIONS

CoB LED technology.
 MINI AL: polymethacrylate lens, beam angles: 8° -24°- 36°.
 MINI TX - 2X - 4X: frosted glass with single, double, quadruple emission.
 MEDIUM AL: polymethacrylate lens, beam 25°- 45°- 60°- 80°.
 MEDIUM HA: intensive asymmetrical lens with internal aluminum reflector.
 MEDIUM WA: wide beam asymmetrical lens with internal aluminum reflector.

BODY

Aluminum with epoxy powder coating.

COLORS

Stainless steel.

* Where available

HALL LED GROUND MINI ACCENT LIGHT

Accessories on page 304. **IP67** **IK10**

Internal polymetacrilate lens.

Beam angle: 8°- 24°- 36°.

CUT OFF > 30°.

Remote driver as accessory. Fixtures supplied with 5mt cable.

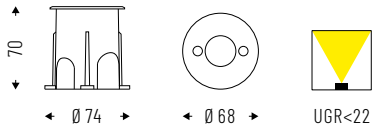

Cod.	Icon	lm	Ø mm
38AL3K38T67	3W 8°	189	68
38AL3K324T67	3W 24°	189	68
38AL3K336T67	3W 36°	189	68

HALL LED GROUND MINI 1X

Accessories on page 304. **IP67** **IK10**

Satin glass with single emission mask.

CUT OFF > 30°.

Remote driver as accessory. Fixtures supplied with 5mt cable.

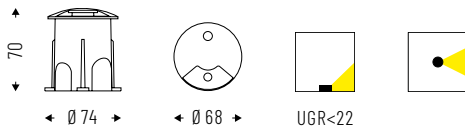

Cod.	Icon	lm	Ø mm
38HS3K3T67	3W	189	68

HALL LED GROUND ^{MINI 2X}

Accessories on page 304. **IP67** **IK10**

Satin glass with double emission mask.
CUT OFF > 30°.

Remote driver as accessory. Fixtures supplied with 5mt cable.

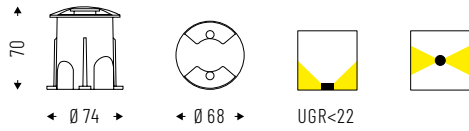

Cod.	W	lm	Ø mm
38HD3K3T67	3W	189	68



HALL LED GROUND ^{MINI 4X}

Accessories on page 304. **IP67** **IK10**

Satin glass with quadruple emission mask.
CUT OFF > 30°.

Remote driver as accessory. Fixtures supplied with 5mt cable.

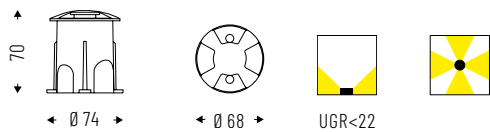

Cod.	W	lm	Ø mm
38HQ3K3T67	3W	189	68



HALL LED GROUND MEDIUM ACCENT LIGHT

Accessories on page 304. **IP 67** **IK10**

Internal polycarbonate lens.
 Beam angles: 25° - 45° - 60° - 80°.
 CUT OFF > 30°.

Built-in driver.

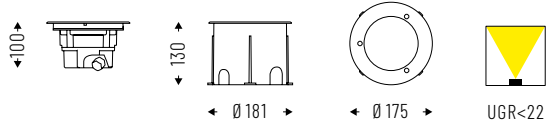

Cod.	Beam	lm	Ø mm
38AL13K325TM67	13W 25°	1495	175
38AL13K345TM67	13W 45°	1495	175
38AL13K360TM67	13W 60°	1495	175
38AL13K380TM67	13W 80°	1495	175

HALL LED GROUND MEDIUM HIGH WALLWASHER

Accessories on page 304. **IP 67** **IK10**

Internal polycarbonate lens.
 Beam angles: 25° - 45° - 60° - 80°.
 CUT OFF > 30°.

Built-in driver.

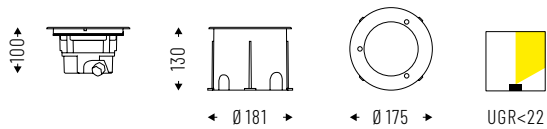

Cod.	Beam	lm	Ø mm
38HA13K3TM67	13W	1495	175

HALL LED GROUND MEDIUM WIDE WALLWASHER

Accessories on page 304. **IP 67** **IK10**

Internal polycarbonate lens.
 Beam angles: 25° - 45° - 60° - 80°.
 CUT OFF > 30°.

Built-in driver.

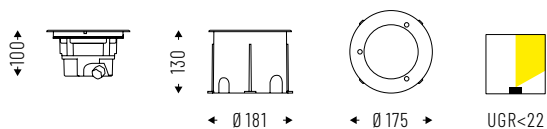

Cod.	Beam	lm	Ø mm
38WA13K3TM67	13W	1495	175

ACCESSORIES



PER HALL LED GROUND MINI



Constant current LED driver for single connection..

38LC4700IS



Constant current LED driver for 2 fixtures.

38LC12700IS



Constant current LED driver for 4 fixtures.

38LC17700IS

PER HALL LED GROUND MEDIUM



Honeycomb optic.

38AANDHG



Micro-engraved glass.

38AASLHG



Frosted glass.

38AAGMHG

TECHNICAL NOTES



HIGH WALLWASHER

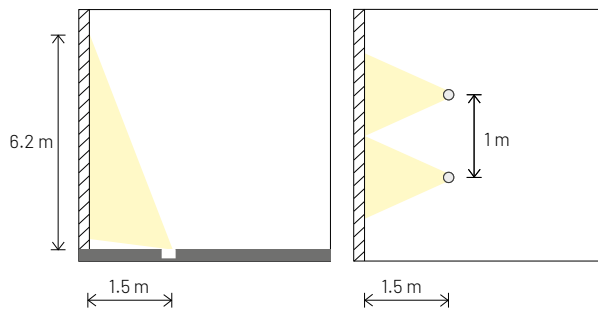
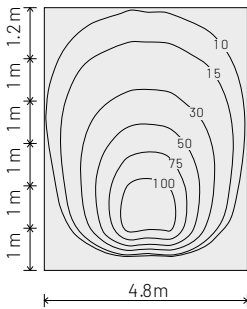

Recommended installation distance.

WIDE WALLWASHER

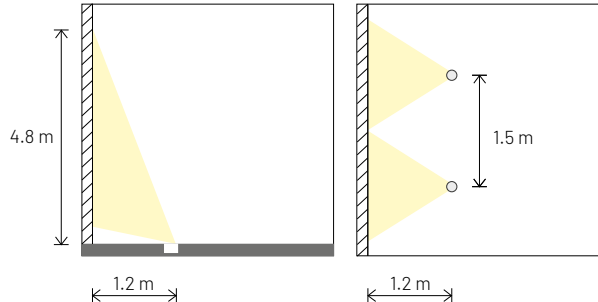
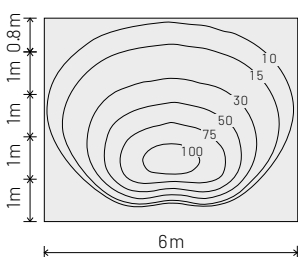





Recommended installation distance.



FEATURES

-  Direct emission
-  UGR < 22
-  IP 67
-  IK 07 / IK 09
-  10 kN

LED

-  3000K
- >100lm/W icon" data-bbox="71 293 98 311"/> >100lm/W
-  CRI > 80
-  Eye safety: RGO
-  Mac Adams 3
-  L80/B10 > 50.000h

CERTIFICATIONS

-  Energy efficiency
-  5 years warranty

ON REQUEST

-  DALI - code D*
-  4000K - code K4*
RGB* / RGBW*

SPECIFICATIONS

Remote driver.
Back-screenprinted
transparent cover glass.
PMMA optics:
Narrow Beam - code NB
Wide Beam - code WB
Asymmetrical - code AS
Double asymmetric - code DAS

BODY

Anodized aluminum.

COLORS

Grey RAL 7035



WALKABOUT

WALKABOUT is the linear solution capable of **highlighting architectural shapes and textures**. Both in the walk-over version, recessed into the ground, and in the wall or ceiling version, it has the **highest degree of protection** (IP 67) while the special optics concentrate the luminous flux in a narrow beam, even in the asymmetric version. The possibility of connecting different length modules of **WALKABOUT** allows to create **continuous light lines**, both on the ground and on the façade, adapting to different architectural solutions **in the outdoor environment**.

ID 93



* Where available

arlico

www.arlico.co.uk » +44 (0) 23 8202 2100 » refer to our website for the complete product range

WALKABOUT

IP 67 IK 07

For single installation,
with adjustable support.

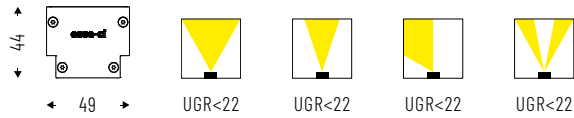

NARROW BEAM OPTICS - NB			
Cod. 3000K	☼	lm	mm
93NB6K3	5.5W	681	276
93NB11K3	11W	1362	526
93NB22K3	22W	2724	1026
93NB33K3	33W	4087	1526

WIDE BEAM OPTICS - WB			
Cod. 3000K	☼	lm	mm
93WB6K3	5.5W	697	276
93WB11K3	11W	1394	526
93WB22K3	22W	2788	1026
93WB33K3	33W	4182	1526

ASYMMETRIC OPTICS - AS			
Cod. 3000K	☼	lm	mm
93AS6K3	5.5W	705	276
93AS11K3	11W	1410	526
93AS22K3	22W	2820	1026
93AS33K3	33W	4229	1526

DOUBLE ASYMMETRIC OPTIC - DAS			
Cod. 3000K	☼	lm	mm
93DAS6K3	5.5W	689	276
93DAS11K3	11W	1378	526
93DAS22K3	22W	2756	1026
93DAS33K3	33W	4134	1526

WALKABOUT^{FC}

IP 67 IK 07

For continuous row installation*
with adjustable support.

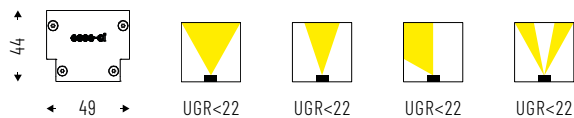

NARROW BEAM OPTICS - NB			
Cod. 3000K	☼	lm	mm
93NB6K3FC	5.5W	681	276
93NB11K3FC	11W	1362	526
93NB22K3FC	22W	2724	1026
93NB33K3FC	33W	4087	1526

WIDE BEAM OPTICS - WB			
Cod. 3000K	☼	lm	mm
93WB6K3FC	5.5W	697	276
93WB11K3FC	11W	1394	526
93WB22K3FC	22W	2788	1026
93WB33K3FC	33W	4182	1526

ASYMMETRIC OPTICS - AS			
Cod. 3000K	☼	lm	mm
93AS6K3FC	5.5W	705	276
93AS11K3FC	11W	1410	526
93AS22K3FC	22W	2820	1026
93AS33K3FC	33W	4229	1526

DOUBLE ASYMMETRIC OPTIC - DAS			
Cod. 3000K	☼	lm	mm
93DAS6K3FC	5.5W	689	276
93DAS11K3FC	11W	1378	526
93DAS22K3FC	22W	2756	1026
93DAS33K3FC	33W	4134	1526

*Provide an element for single installation - with relative overall dimensions - at the end of the continuous row.

WALKABOUT GROUND

IP 67 IK 09

For single walk-over installation.
Recessed box included.

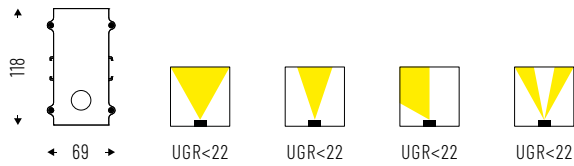

NARROW BEAM OPTICS - NB			
Cod. 3000K	☹	lm	mm
93NB6K3G	5.5W	681	287
93NB11K3G	11W	1362	537
93NB22K3G	22W	2724	1037
93NB33K3G	33W	4087	1537

WIDE BEAM OPTICS - WB			
Cod. 3000K	☹	lm	mm
93WB6K3G	5.5W	697	287
93WB11K3G	11W	1394	537
93WB22K3G	22W	2788	1037
93WB33K3G	33W	4182	1537

ASYMMETRIC OPTICS - AS			
Cod. 3000K	☹	lm	mm
93AS6K3G	5.5W	705	287
93AS11K3G	11W	1410	537
93AS22K3G	22W	2820	1037
93AS33K3G	33W	4229	1537

DOUBLE ASYMMETRIC OPTIC - DAS			
Cod. 3000K	☹	lm	mm
93DAS6K3G	5.5W	689	287
93DAS11K3G	11W	1378	537
93DAS22K3G	22W	2756	1037
93DAS33K3G	33W	4134	1537

WALKABOUT GROUND FC

IP 67 IK 09

For continuous row walk-over installation*.
Recessed box included.

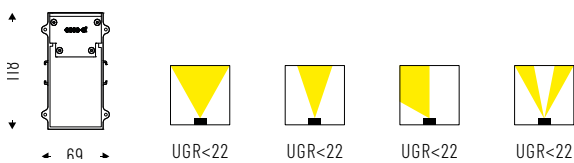

NARROW BEAM OPTICS - NB			
Cod. 3000K	☹	lm	mm
93NB6K3GFC	5.5W	681	278
93NB11K3GFC	11W	1362	528
93NB22K3GFC	22W	2724	1028
93NB33K3GFC	33W	4087	1528

WIDE BEAM OPTICS - WB			
Cod. 3000K	☹	lm	mm
93WB6K3GFC	5.5W	697	278
93WB11K3GFC	11W	1394	528
93WB22K3GFC	22W	2788	1028
93WB33K3GFC	33W	4182	1528

ASYMMETRIC OPTICS - AS			
Cod. 3000K	☹	lm	mm
93AS6ASK3GFC	5.5W	705	278
93AS11ASK3GFC	11W	1410	528
93AS22ASK3GFC	22W	2820	1028
93AS33ASK3GFC	33W	4229	1528

DOUBLE ASYMMETRIC OPTIC - DAS			
Cod. 3000K	☹	lm	mm
93DAS6K3GFC	5.5W	689	278
93DAS11K3GFC	11W	1378	528
93DAS22K3GFC	22W	2756	1028
93DAS33K3GFC	33W	4134	1528

*Provide an element for single installation - with relative overall dimensions - at the end of the continuous row.

ACCESSORIES



ON/OFF Driver (IP 67)

93LC1324IS67
93LC3524IS67
93LC7524IS67
93LC10024IS67



Junction kit for walk-over recessed box.

93AA11CC



Removal kit for Walkabout Ground / FC.

93AATLCC



Plates kit for Driver mounting on Walkabout / FC bar.

93AABD

TECHNICAL NOTES



GROUND INSTALLATION WITH WALKABLE OUTER CASING FOR WALKABOUT GROUND AND WALKABOUT GROUND FC MODEL

DRIVER INSERTION

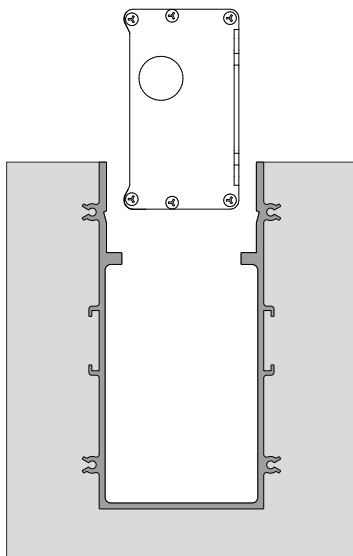

WALKABOUT GROUND INSERTION

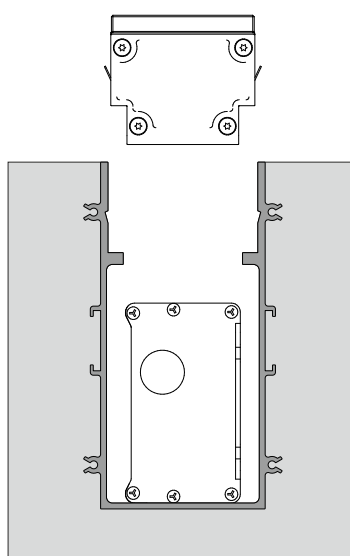



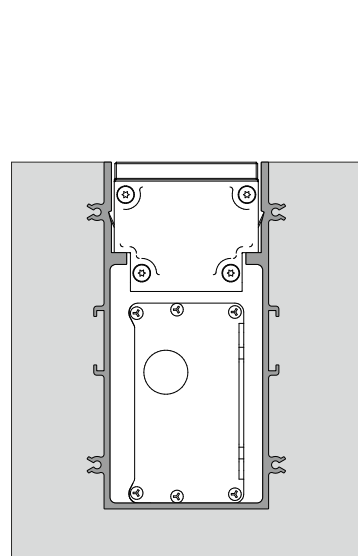



RECESSED BOX INSTALLATION



FEATURES

-  Adjustable emission
-  UGR <22
-  IP66
-  IK 06
-  -20°C +40°C

LED

-  3000K
-  >108 lm/W; >120 lm/W
-  CRI >90
-  Eye safety: RG0/RG1
-  Mac Adams 3
-  L80/B10 >50.000h

CERTIFICATIONS

-  EEA Conformity
-  Energy efficiency
-  5 years warranty

ON REQUEST

-  2700K - code K27*
- 4000K - code K4*
- 5000K - code K5*

SPECIFICATIONS

Built-in driver.
Internal aluminum reflectors,
beam angles: 10° - 20° - 40° - 50° - 70°.

BODY

Aluminum with epoxy
powder coating.

COLORS

White RAL 9003 wrinkled
- code W
Black RAL 9005 wrinkled
- code BK
Anthracite grey - code GA
Corten Bronze - code BC

RELATED PRODUCTS

Teres (P. 188)
Teres Exte (P. 195)
Teres Micro Zoom (P. 213)
Teres LV (P. 215)

*Verificata diennihilità



Perfectly complementing the already extensive TERES interiors collection, **TERES IP66** high ingress protection rating makes it **perfect for outdoor environment**, gardens, planters and **accent lighting for signs and architecture**. The **built-in driver** and the dedicated connection compartment ensure the product is easy to install. The range of beam angles and graduated pointing system is designed for **easy and precise focusing**. The product can either be mounted directly on surfaces or attached to a spike mount, for a more flexible ground installation.

ID 14



OUTDOOR IP

TERES IP66 SMALL

Accessories on page 19.

IP66 **IK06**

Internal aluminum reflectors.
Beam angles: 10° - 20° - 40° - 50°.

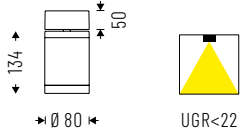

Cod. 3000K		lm	Ø mm
14VT18K310S66	18W 10°	1945	80
14VT18K320S66	18W 20°	1945	80
14VT18K340S66	18W 40°	1945	80
14VT18K350S66	18W 50°	1945	80

TERES IP66 MEDIUM

Accessories on page 19.

IP66 **IK06**

Internal aluminum reflectors.
Beam angles: 10° - 20° - 40° - 70°.

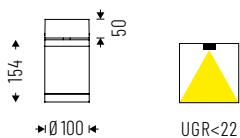

Cod. 3000K		lm	Ø mm
14VT31K310M66	31W 10°	3286	80
14VT31K320M66	31W 20°	3286	80
14VT31K340M66	31W 40°	3286	80
14VT31K370M66	31W 70°	3286	80

ACCESSORIES



TERES IP66 SMALL
Ground installation spike.

14AA21S



TERES IP66 SMALL
Adapter with belt
for tree mount.

14AA18S



TERES IP66 SMALL
Wall arm connection,
length 700mm.

14AA15S



TERES IP66 MEDIUM
Ground installation spike.

14AA21M



TERES IP66 MEDIUM
Adapter with belt
for tree mount.

14AA18M



TERES IP66 MEDIUM
Wall arm connection,
length 700mm.

14AA15M

TECHNICAL NOTES



Graduated adjustment.



Osmotic valve.



Holes for the rainwater drainage.



MOON

MOON is the new device for **wall or ceiling installations**. The minimal design and **IP65 protection** rating make it suitable for general lighting in any context, both indoor and outdoor, such as stairs, corridors, passageways, parking lots and wherever sober lighting is needed.







ID 51



FEATURES

-  Direct emission
-  UGR < 22
-  IP 65
-  IK 10
-  -25°-> +40°/45°
-  750°



LED

-  3000K/4000K
-  >100 lm/W
-  CRI > 80
-  Eye safety: RGO/RG1
-  Mac Adams 3
-  L80/B10 >50.000h

CERTIFICATIONS

-  EEA Conformity
-  Energy efficiency
-  5 years warranty

ON REQUEST

-  DALI - code D*
-  Emergency 1 hr - code EM*
Emergency 3 hrs - code EM3H*

SPECIFICATIONS

SMD LED technology.
Built-in driver.
Impact resistant polycarbonate diffuser.

BODY

Polycarbonate.

COLORS

White RAL 9003 - code B
Black RAL 9005 - code C8

* Where available

MOON SMALL

IP 65 IK10

Impact resistant polycarbonate diffuser.

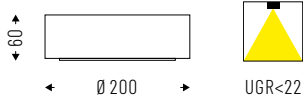

Cod. 4000K	Icon	lm	Ø mm
51P013K4S65	13W	1158	200

Cod. 3000K	Icon	lm	Ø mm
51P013K3S65	13W	1055	200

MOON MEDIUM

IP 65 IK10

Impact resistant polycarbonate diffuser.

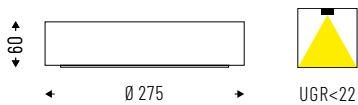

Cod. 4000K	Icon	lm	Ø mm
51P018K4M65	18W	2014	275
51P025K4M65	25W	2515	275

Cod. 3000K	Icon	lm	Ø mm
51P018K3M65	18W	1921	275
51P025K3M65	25W	2340	275

MOON LARGE

IP 65 IK10

Impact resistant polycarbonate diffuser.

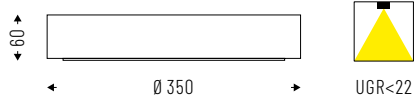

Cod. 4000K		lm	Ø mm
51P027K4L65	27W	3173	350

Cod. 3000K		lm	Ø mm
51P027K3L65	27W	3005	350

MOON INTELLIGENT

IP 65 IK10

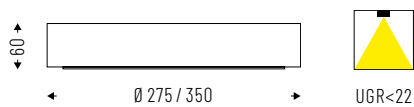

Impact resistant polycarbonate diffuser.
Built-in presence sensor.









Cod. 4000K		lm	Ø mm
51P018K4M65I	18W	2014	275
51P025K4M65I	25W	2515	275
51P027K4L65I	27W	3173	350

Cod. 3000K		lm	Ø mm
51P018K3M65I	18W	1921	275
51P025K3M65I	25W	2340	275
51P027K3L65I	27W	3005	350

FEATURES

-  Direct emission
-  UGR <22
-  IP 44 SOSPENSIONE - IP 54

LED

-  3000K/4000K
-  >125 lm/W
-  CRI >90
-  Eye safety: R60/R61
-  Mac Adams 3
-  L80/B10 >50.000h

CERTIFICATIONS

-  EEA Conformity
-  Energy efficiency
-  5 years warranty

ON REQUEST

-  DALI - code D*
-  Bluetooth - code BT*
-  Emergency 1 hr - code EM*
Emergency 3 hrs - code EM3H*
-  2700K - code K27*

SPECIFICATIONS

Built-in driver.
Impact resistant satin acrylic diffuser with perimeter screen printing and homogeneous emission with UGR <22.
Circular aluminum frame with sealing gasket.

BODY

Aluminum with epoxy powder coating.

COLORS

Matte white RAL 9003 - code B

RELATED PRODUCTS

Ben suspended/ceiling (P. 84)
Ben recessed (P. 124)
Ben wall (P. 249)

* Where available

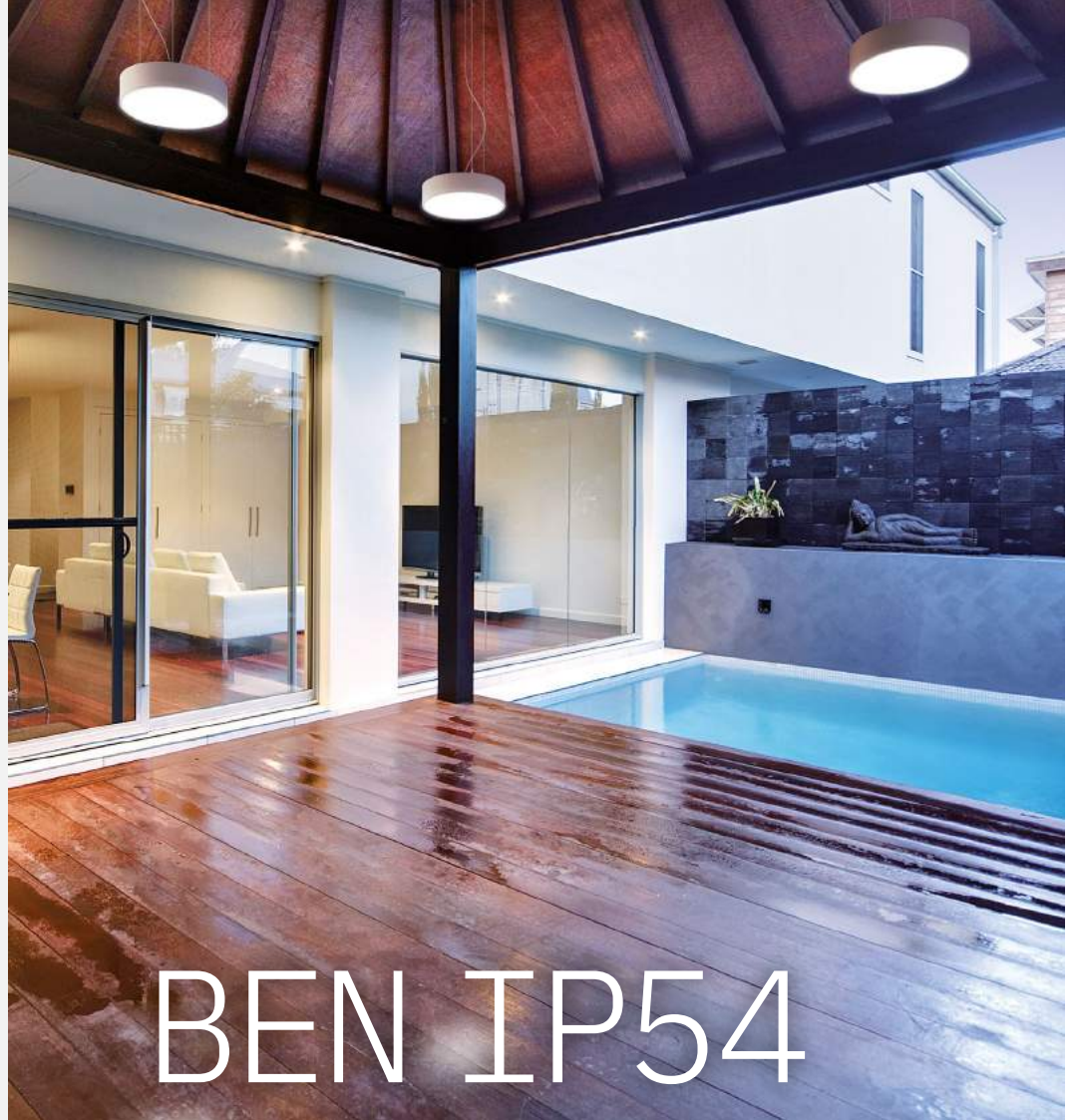

BEN is the **universal fixture** in **spun aluminium**, for wall, ceiling, suspended or recessed applications. Its high level of ingress protection are offered as standard, making this a truly versatile collection. For applications where low glare is desirable, DPL optics are offered (IP40) which have a glare rating of UGR <19. A satin opal diffuser is also offered for soft broad-beam distribution (UGR <22). This version is also offered as an IP54 for wet area applications. **The LED boards are mounted on circular aluminium frames** for optimum thermal management and the quick-fit connectors facilitate a rapid installation. Dimmable and emergency versions complete the range.

ID 10



BEN SMALL IP54

Suspended

IP 44

IP 54

Impact resistant satin-acrylic diffuser with perimeter screen printing, UGR <22.

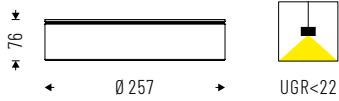

Cod. 4000K	Icon	lm	Ø mm
10PG6K454	6W	824	257
10PG12K454	12W	1647	257
10PG18K454	18W	2471	257

Cod. 3000K	Icon	lm	Ø mm
10PG6K354	6W	783	257
10PG12K354	12W	1564	257
10PG18K354	18W	2352	257

BEN MEDIUM IP54

Suspended

IP 44

IP 54

Impact resistant satin-acrylic diffuser with perimeter screen printing, UGR <22.

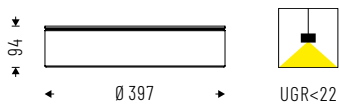

Cod. 4000K	Icon	lm	Ø mm
10PG16K454	16W	2412	397
10PG25K454	25W	3766	397

Cod. 3000K	Icon	lm	Ø mm
10PG16K354	16W	2291	397
10PG25K354	25W	3578	397

BEN LARGE IP54

Suspended

IP 44

IP 54

Impact resistant satin-acrylic diffuser with perimeter screen printing, UGR <22.



Cod. 4000K	☼	lm	Ø mm
10PG60K454	60W	8224	620
10PG112K454	112W	15351	620

Cod. 3000K	☼	lm	Ø mm
10PG60K354	60W	7812	620
10PG112K354	112W	14583	620

ACCESSORIES



Single wire adjustable suspension kit. Cable length 1500 / 3000 mm.

10AA13
10AA1330



3 - 5 poles ceiling power supply cable. Cable length 2000mm

10AA16
10AA165P



Kit for recessed frameless installation on plasterboard and concrete.

10AA19SFL - BEN SMALL
10AA19MFL - BEN MEDIUM
10AA19LFL - BEN LARGE



Kit for recessed installation.

10AA19S - BEN SMALL
10AA19M - BEN MEDIUM
10AA19L - BEN LARGE





GLEIS

GLEIS is the **adjustable direct-indirect emission** outdoor wall luminaire. Thanks to **two rotating elements**, perfectly integrated within its body and the high-performance **concentrating optics**, the light flux can be flexibly oriented to create **different light effects**. With an extremely compact body and a modern and minimal design available in different colors, **GLEIS** integrates perfectly into any environment. **From wall washer to spotlight with a touch: GLEIS** is the perfect solution to flexibly illuminate walls and passageways in outdoor environments at the same time.

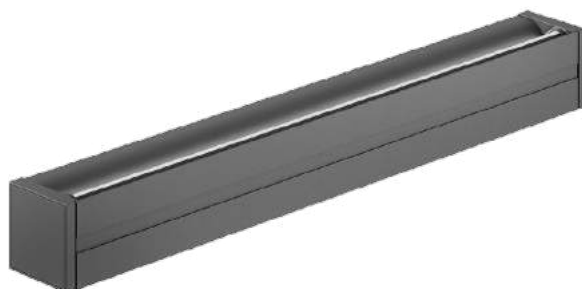





ID 61





FEATURES

-  Direct/Indirect emission
-  UGR < 22
-  IP 66



LED

-  3000K/4000K
-  >100lm/W
-  CRI >90
-  Eye safety: R60/R61
-  Mac Adams 3
-  L80/B10 >50.000h

CERTIFICATIONS

-  Energy efficiency
-  5 years warranty

ON REQUEST

-  DALI - code D
-  Bluetooth - code BT*
-  Emergency 1 hr - code EM*
Emergency 3 hrs - code EM3H*

SPECIFICATIONS

Built-in driver.
Adjustable concentrating optics
and independent with UGR < 22.

BODY

Aluminum with epoxy
powder coating.

COLORS

White RAL 9003 wrinkled
- code W
Black RAL 9005 wrinkled
- code BK
Anthracite grey - code GA
Corten bronze - code BC

* Where available

GLEIS

IP 66

Concentrating optics for direct and indirect emission, independent and rotating (90°).

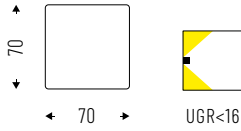

Cod. 4000K	☼	lm	mm
61DI12K4	12W	1068	340
61DI24K4	24W	2136	620
61DI36K4	36W	3204	900
61DI48K4	48W	4272	1180
61DI60K4	60W	5340	1463

Cod. 3000K	☼	lm	mm
61DI12K3	12W	950	340
61DI24K3	24W	1901	620
61DI36K3	36W	2851	900
61DI48K3	48W	3802	1180
61DI60K3	60W	4752	1463

TECHNICAL NOTES



ROTATING ELEMENTS ADJUSTMENT

The concentrating optics, mounted on rotating elements, allow the luminous flux to be directed independently by 90 degrees towards the wall - for a wallwasher effect - or towards the outside - with a spotlight function - to illuminate walls, paths or areas at the same time passing.

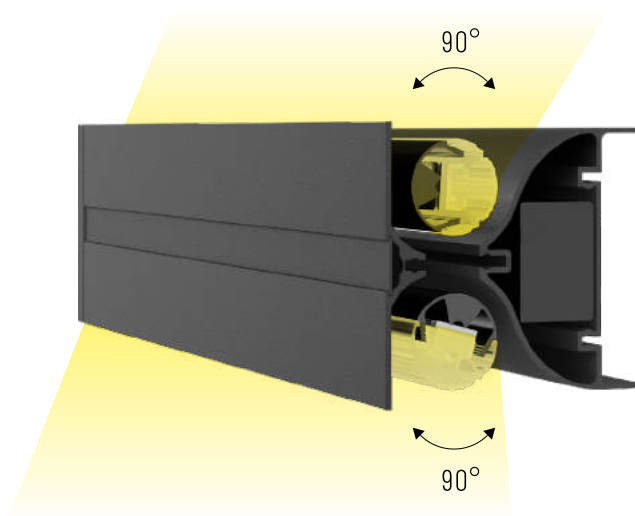

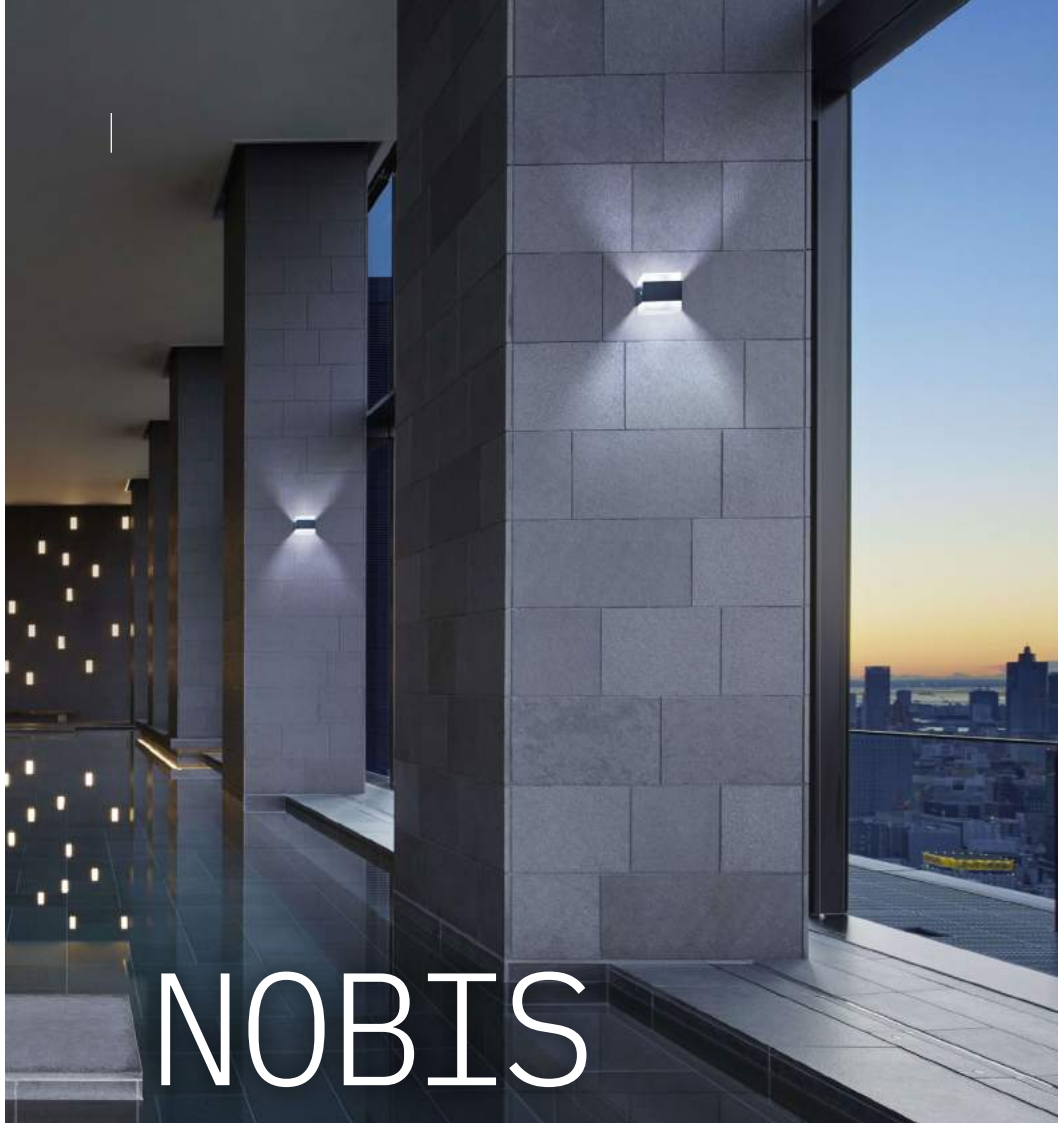

NOBIS

NOBIS's family is designed for **wall and ceiling installation**, declined also in **bollard, ground, semi-recessed and USB versions**. The sliding optical system **allows to direct the beam** and thanks to the endless **possibilities of colors** of the cover this family is the ideal solution in every context.





ID 90



FEATURES

-  Direct emission
-  UGR <22
-  IP 66
-  IK 07
-  -20° / +40°

LED

-  3000K
- >52 lm/W icon" data-bbox="761 293 788 310"/> >52 lm/W
-  CRI >80
-  Eye safety: RG0/RG1
-  Mac Adams 3
-  L80/B10 >50.000h

CERTIFICATIONS

-  EEA Conformity
-  Energy efficiency
-  5 years warranty

ON REQUEST

-  4000K - code K4*

SPECIFICATIONS

Built-in driver.
Satin polycarbonate diffuser.

BODY

Shockproof, antistatic technopolymer with an exclusive treatment that guarantees a homogeneous emission over the entire surface.

COLORS

White RAL 9003 wrinkled
- code W
Black RAL 9005 wrinkled
- code BK
Anthracite gray - code GA
Corten bronze - code BC

* Where available

NOBIS ^{MINI}

Accessories on page 323. **IP 66** **IK07**

Satin polycarbonate diffuser.

Equipped with 2000mm cable.

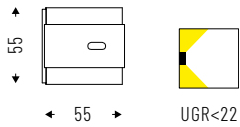

Cod. 3000K		lm	L mm
90PC3K366	3W	208	55

NOBIS

Accessories on page 323. **IP 66** **IK07**

Satin polycarbonate diffuser.

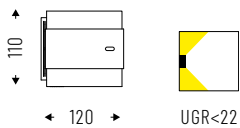

Cod. 3000K		lm	L mm
90PC13K366	13W	696	110

NOBIS ^{USB}

Accessories on page 323. **IP 66** **IK07**

Satin polycarbonate diffuser screen with power button and color temperature selection between 2700 K / 3500 K / 4500 K.

Device with built-in batteries, rechargeable via USB socket. 5h autonomy.

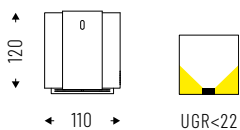



Cod. 3000K		lm	L mm
90PC2USB66	2W	140	110

NOBIS BOLLARD

IP 66 IK07

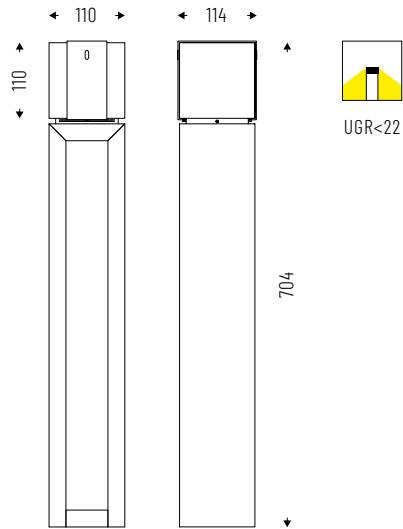
Satin polycarbonate diffuser.





Cod. 3000K		Im	L mm
90PC13K3B66	13W	696	110

NOBIS GROUND

IP 66 IK07

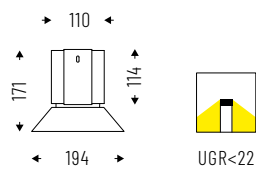
Satin polycarbonate diffuser.



Cod. 3000K		Im	L mm
90PC13K3G66	13W	696	110(194)

ACCESSORIES

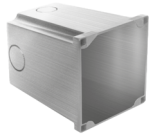

NOBIS MINI
box for semi-recessed
wall installation.

90AA19

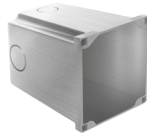

NOBIS
box for semi-recessed
wall installation.

90AA19S

TECHNICAL NOTES



ADJUSTABLE COVER

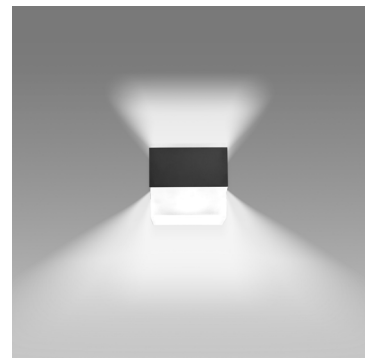
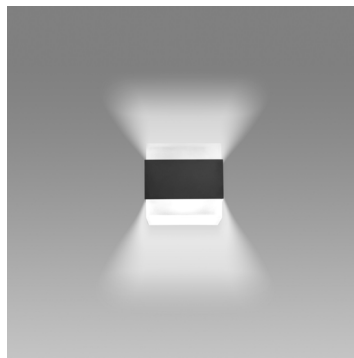
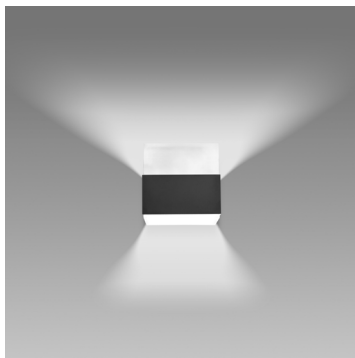

AVAILABLE COVER COLORS:

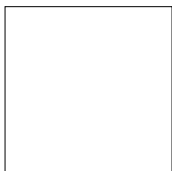

White
RAL 9003
Code: W



Black
RAL 9005
Code: BK



Anthracite gray
Code: GA

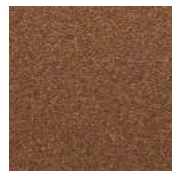

Corten bronze
Code: BC

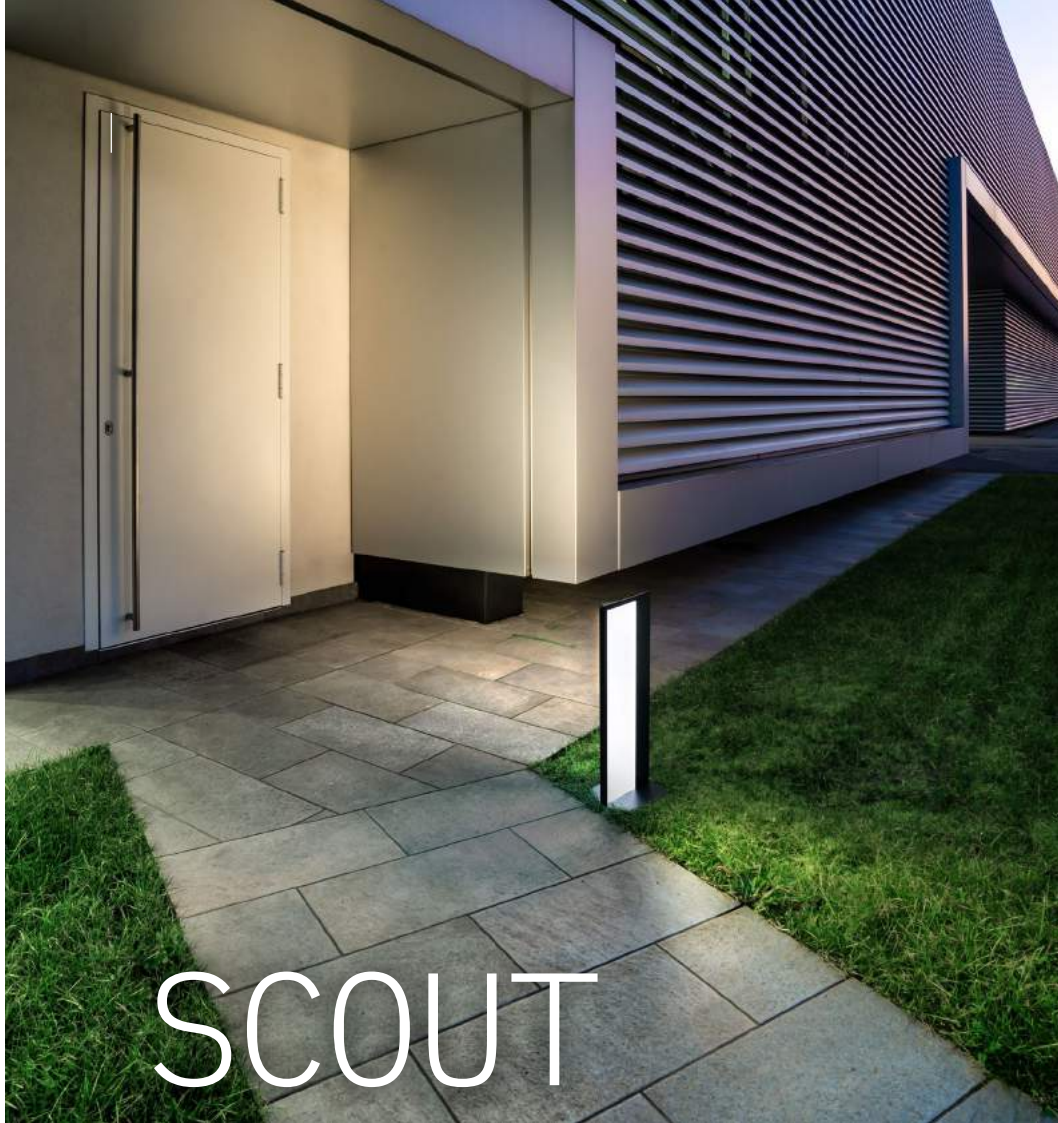

SCOUT

SCOUT is an architectural element with refined style able to offer **a new solution for the outdoor world**, with a look always attentive to aesthetic and a design focused on innovation and new technologies. What makes **SCOUT** aesthetically interesting is the peculiarity of **the diffuser: totally invisible when turned off and evenly lit when turned on**, thanks to micro-incisions that are affected by the light source, ensuring **high visual comfort and uniform outwards emission**.







ID 91



FEATURES

-  Direct emission
-  UGR <22
-  IP66
-  IK 06
-  -20°C +40°C



LED

-  3000K
-  >100 lm/W
-  CRI >90
-  Eye safety: RG0/RG1
-  Mac Adams 3
-  L80/B10 >50.000h

CERTIFICATIONS

-  EEA Conformity
-  Energy efficiency
-  5 years warranty

ON REQUEST

-  2700K - code K27*
-  K4000 - code K4*
-  5000K - code K5*

SPECIFICATIONS

Built-in driver.
Backlit Plexiglass diffuser.
Backlight LGP (Light Guide Panel).

BODY

Die-cast aluminum with epoxy powder coating.

COLORS

White RAL 9003 wrinkled - code W
Black RAL 9005 wrinkled - code BK
Anthracite gray - code GA
Corten bronze - code BC

* Where available

SCOUT

IP 66 IK06

LGP (Light Guide Panel) diffuser in backlight plexiglass with microncisions, designed to ensure uniform emission of light outwards.

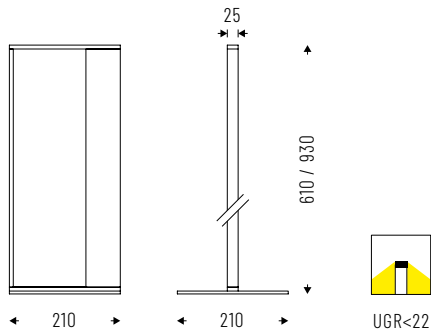

Cod. 3000K	Icon	lm	L mm
91PC9K366	9W	180	610
91PC13K3L66	13W	260	930

SCOUT SPOT

IP 66 IK06

Double adjustable spot, beam angle: 35°.

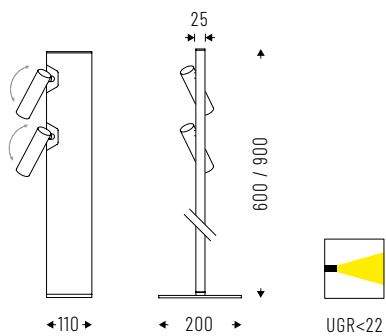

Cod. 3000K	Icon	lm	L mm
91AA23K366	2x3W	374	600
91AA23K3L66	2x3W	374	900

SCOUT SPOT DOUBLE EMISSION

IP 66 IK06

Double spot with 35° beam angle and asymmetrical ground oriented back emission.

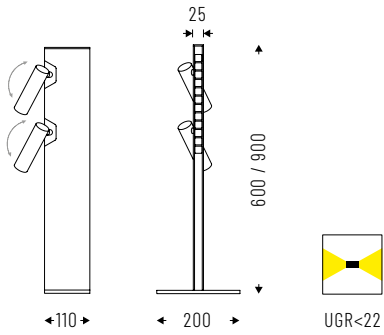







Cod. 3000K	☼	lm	L mm
91DI3S23K366	3W + 2x3W	60 + 374	600
91DI5S23K3L66	5W + 2x3W	100 + 374	900

FEATURES

-  Direct emission
-  UGR < 22
-  IP 66
-  IK 08
-  -30° / +45°



LED

-  4000K
-  >125 lm/W
-  CRI > 80
-  Eye safety: RG0/RG1
-  Mac Adams 3
-  L80/B10 >50.000h

CERTIFICATIONS

-  EEA Conformity
-  Energy efficiency
-  5 years warranty

ON REQUEST

-  DALI - code D
-  3000K - code K3*
5000K - code K5*

SPECIFICATIONS

Built-in driver.
NBE: concentrating polycarbonate lens.
WBE: diffusing polycarbonate lens.
AS: polycarbonate lens with asymmetrical emission.
HW: polycarbonate lens with intensive asymmetric emission.

BODY

Die cast aluminum with epoxy powder coating.

COLORS

Double color:
light gray RAL 7035
black RAL 9017
One color:
black RAL 9017 - code BK.

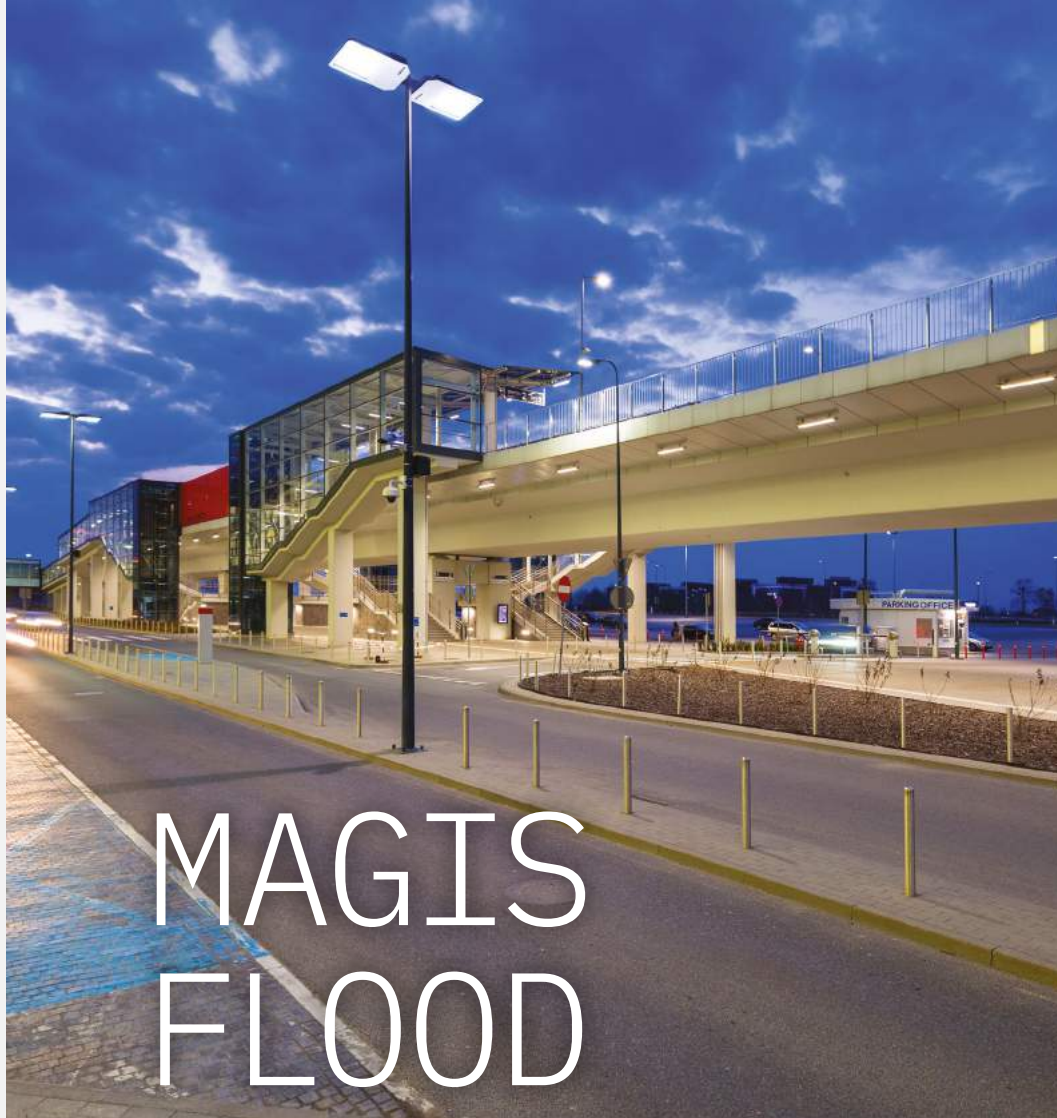

MAGIS FLOOD

MAGIS FLOOD is a range of **indoor and outdoor IP66 luminaires** designed for use in **ambitious sports or large areas**. The wide range of optics, combined with the wide range of powers, makes it an extremely versatile floodlight.

ID 92



Design
Delineo Design

MAGIS FLOOD MEDIUM NBE

Accessories on page 332. **IP 66** **IK08**

Polycarbonate lens with narrow emission.

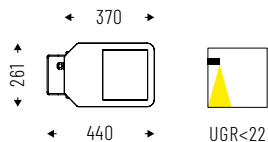

Cod. 4000K		lm	mm
92NBE100K4M	100W	13100	261x440
92NBE150K4M	150W	19620	261x440



MAGIS FLOOD MEDIUM AS

Accessories on page 332. **IP 66** **IK08**

Polycarbonate lens with asymmetric emission.

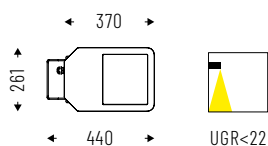

Cod. 4000K		lm	mm
92AS100K4M	100W	12535	261x440
92AS150K4M	150W	18803	261x440



MAGIS FLOOD MEDIUM WBE

Accessories on page 332. **IP 66** **IK08**

Polycarbonate lens with diffusing emission.

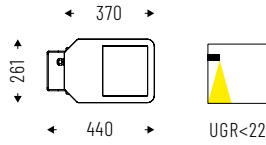

Cod. 4000K		lm	mm
92WBE100K4M	100W	13625	261x440
92WBE150K4M	150W	20438	261x440

MAGIS FLOOD MEDIUM HW

Accessories on page 332. **IP 66** **IK08**

Polycarbonate lens with high wallwasher emission.

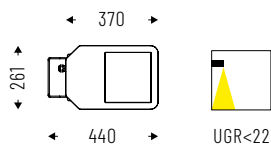

Cod. 4000K		lm	mm
92HW100K4M	100W	12535	261x440
92HW150K4M	150W	18803	261x440

MAGIS FLOOD LARGE NBE

Accessories on page 332. **IP 66** **IK08**

Polycarbonate lens with narrow emission.

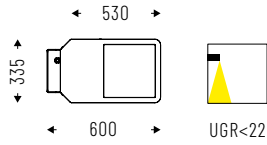

Cod. 4000K		lm	mm
92NBE200K4L	200W	27200	335x600
92NBE250K4L	250W	33900	335x600
92NBE300K4L	300W	40680	335x600

MAGIS FLOOD LARGE AS

Accessories on page 332. **IP 66** **IK08**

Polycarbonate lens with asymmetric emission.

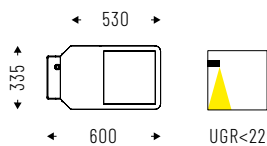

Cod. 4000K		lm	mm
92AS200K4L	200W	25990	335x600
92AS250K4L	250W	32488	335x600
92AS300K4L	300W	38985	335x600

MAGIS FLOOD LARGE WBE

Accessories on page 332. **IP 66** **IK08**

Polycarbonate lens with diffusing emission.

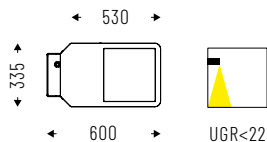

Cod. 4000K		lm	mm
92WBE200K4L	200W	28250	335x600
92WBE250K4L	250W	35313	335x600
92WBE300K4L	300W	42375	335x600

MAGIS FLOOD LARGE HW

Accessories on page 332. **IP 66** **IK08**

Polycarbonate lens with high wallwasher emission.

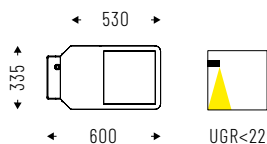

Cod. 4000K		lm	mm
92HW200K4L	200W	25990	335x600
92HW250K4L	250W	32488	335x600
92HW300K4L	300W	38985	335x600

ACCESSORIES



Protection grid.

92AAGPM - MEDIUM
92AAGPL - LARGE



Eyelid for glare control.

92AAVIM - MEDIUM
92AAVIL - LARGE



Wall corner bracket.

92AASP



Pole fixing kit.

92AATP

LIGHT MANAGEMENT



C
H
A
P
T
E
R

T
H
I
R
T
E
E
N

MANAGEMENT SYSTEMS **335**

DIMKIT-28 **336**

DALI BASIC **337**

DIMKIT-13 **338**

DIMKIT-BT **340**

DIMKIT HCL-BT **341**

DALI STAND-ALONE ELEMENTS **342**

DALI-2 STAND-ALONE ELEMENTS **344**

BLUETOOTH/CASAMBI STAND-ALONE ELEMENTS **346**



LIGHT MANAGEMENT

Lighting fixtures are increasingly technological and at the service of the user. Thanks to **modern light management systems** that also allow information retrieval, the luminaires become part of a plant infrastructure that help us save energy, improve

comfort and “map” the system by interacting with its users. Esse-Ci has developed **light management solutions** that can be installed independently (stand alone) and connected (wired or wireless) or solutions totally integrated into the luminaires.



MANAGEMENT SYSTEMS



ON/OFF PRESENCE SENSOR

High quality stand alone On/Off sensor for presence control in semi-automatic mode. It includes an intelligent photocell to prevent power-on when natural light is available. Thanks to the remote control it is possible to set and memorize different programs.

Interface	Wiring	Target	Features	
DIMKIT-28	Wired	Offices/Schools small and medium areas	Manual Presence	Natural light sensor Programmable

DALI-2

The DALI / DALI-2 protocol allows maximum flexibility and adaptability in lighting control via software, without modifying the hardware. The devices can be easily managed even after installation, allowing the automation of the system.



Interface	Wiring	Target	Features	
DALI BASIC Collegamneto Switch-Dim	Wired	Offices/Schools small and medium areas	Manual	Up to 35 devices
DIMKIT-13	Wired	Offices/Schools small and medium areas	Manual Presence	Constant light Up to 20 DALI addresses on 2 channels (10 + 10) with offset functionality

BLETOOTH CASAMBI

Bluetooth on Casambi standard allows to manage the network of devices or wireless sensors (eg presence / light sensors) through a remote control from the App. The same network can contain 127 nodes, with the possibility of controlling multiple networks simultaneously. Each node can talk to another in the BT coverage area up to a maximum of 50m. System security is guaranteed by encrypted protocols between the individual Casambi units. Each request is based on user privileges and is uniquely authenticated between smartphones/tablets and Casambi devices.



Interface	Wiring	Target	Features	
DIMKIT BT	Wireless	Offices/Schools small and medium areas	Manual With free dedicated iOS and Android management App.	Presence Constant light Up to 127 nodal points

HCL: HUMAN CENTRIC LIGHT

Latest generation tunable white LED technology allows the management of adjustable color temperatures along the Planck curve, from 2700K to 6500K, from a warm light to a cold light. The HCL system reproduces the natural rhythms of light in every interior space, resulting in numerous benefits for the human body: regularization of the biorhythm, improved mood and increased productivity.



Interface	Wiring	Target	Features	
DIMKIT HCL-BT	Wired	Offices, Schools, Retail, Hospitals	Manual With free dedicated management App for iOS	Presence Constant lighting Up to 40 addresses Dali dt8

DIMKIT-28 ON/OFF PRESENCE SENSOR

IP 20

DIMKIT28 includes a high quality **stand alone On/Off sensor** designed for presence control in **semi-automatic mode**. The intelligent photocell prevents power-on when natural light is available. The setting and adjustment of the sensor are carried out using a **remote control**, which allows to store **common settings for multiple devices**. For **recessed or ceiling** installation.



DIMKIT28

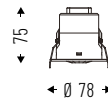

DIMKIT28P

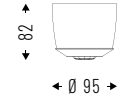

Cod.
DIMKIT28
Recessed version sensor.

Cod.
DIMKIT28P
Ceiling version sensor.

TECHNICAL NOTES



Connection diagram.

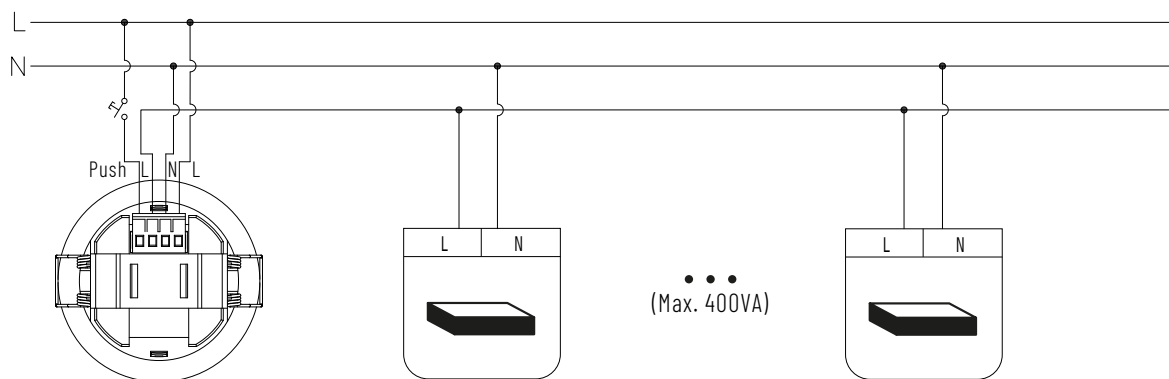

ACCESSORIES



Programmable remote control with memorization of different settings, for a simplified management of sensors.

DIMKIT28 PROG

DALI BASIC SWITCH-DIM CONNECTION



IP 20

DALI BASIC is a **dimmer with push button control** for LED fixtures via **DALI/DALI-2 protocol**, for dimming from 1 to 100%. The control unit allows to control a maximum of 35 dimmable fixtures via button. **Connected directly** to the button, it allows the following functions:

- a short press to turn on and off;
- a long press to increase or decrease the light intensity.

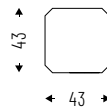
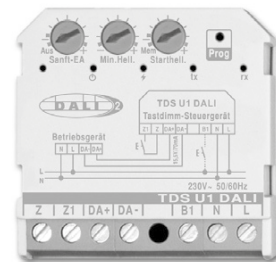

Cod.

DIMTDS

TECHNICAL NOTES

Connection diagram.

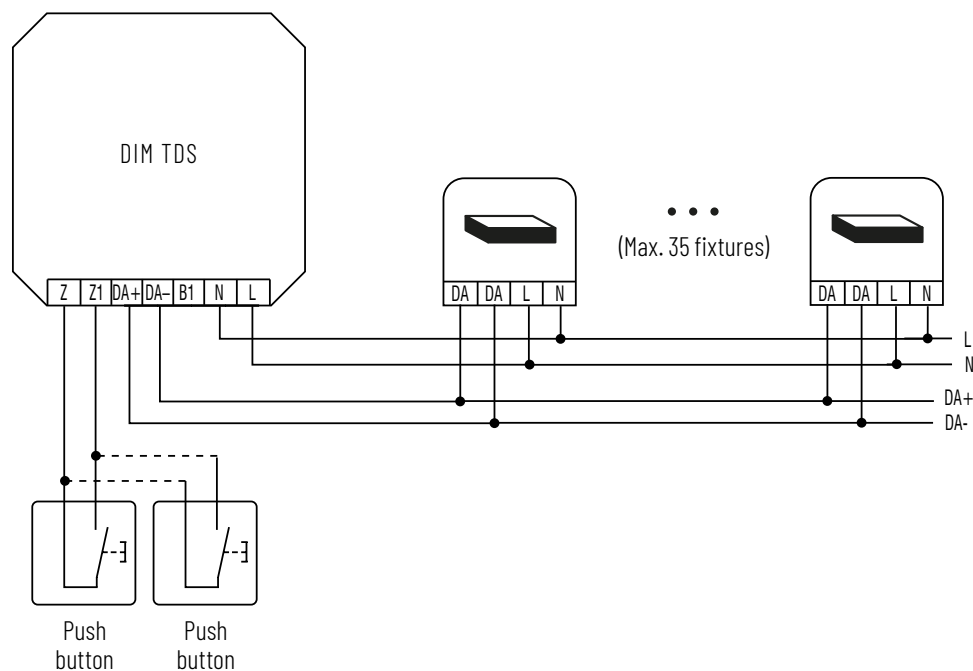

DIMKIT-13



DIMKIT13 includes a sensor for automatic adjustment with constant light function, presence detection and push button control of up to 20 DALI drivers. An **easy to use and affordable** automatic light management system with motion detector. It controls two groups of up to 10 DALI addresses each and allows the management of the offset between groups 1 and 2. When the sensor detects a movement, it activates a profile and activates the fixtures, which **automatically adjust according to natural light**. Connected devices can also be turned on and off with a button or optional remote control. To program the system a DIMILD2PROG infrared programmer is requested.



SENSILD2M

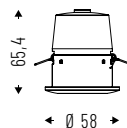

SENSILD2MP

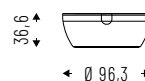

Cod.	Cod.
DIMKIT13	DIMKIT13P
Recessed version sensor.	Ceiling version sensor.



DIMILD2A



DIMILD2PB

TECHNICAL NOTES



Connection diagram.

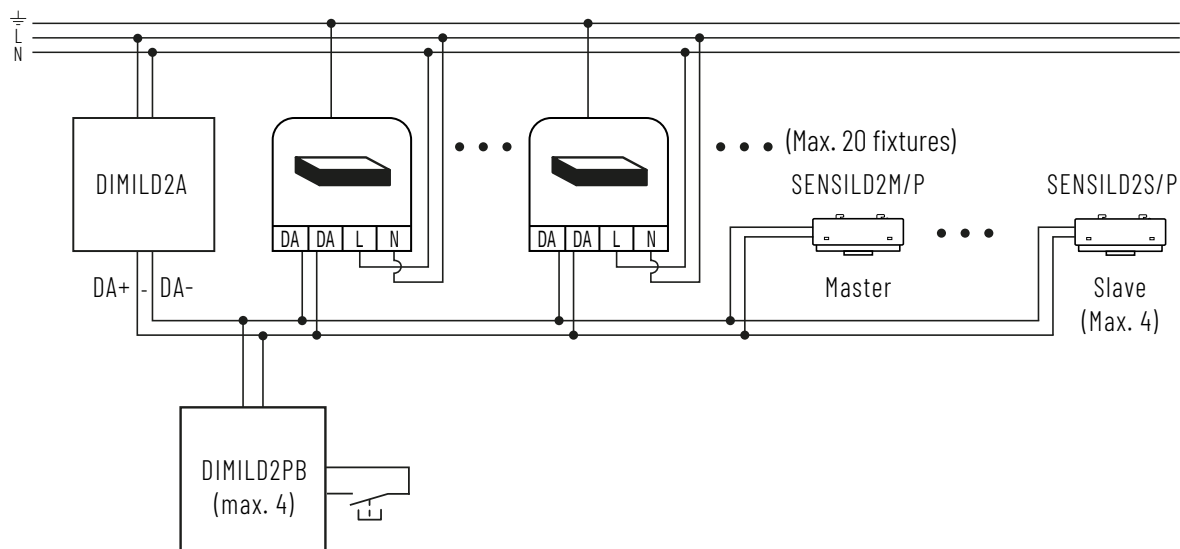

ACCESSORIES



Sensor with automatic adjustment, constant light and presence detection functions. Recessed version (slave).

SENSILD2S



Sensor with automatic adjustment, constant light and presence detection functions. Ceiling version (slave).

SENSILD2SP



Infrared remote control for programming. Setting of predefined parameters and programmable functions.

DIMILD2PROG



Infrared remote control for switching on and off, with manual or automatic light intensity adjustment.

DIMRCILD2



Button interface for control points extension, for DIMKIT13 and DIMKIT13P

DIMIL2PB

DIMKIT-BT

Bluetooth® CASAMBI

IP 20

DIMKITBT allows control via Casambi Ready Bluetooth protocol with Wireless system. **It allows to adjust lighting according to ambient light and presence detection.** It can also be **managed wirelessly via Android and iOS devices** as it automatically forms a wireless communication network of up to 250 nodes. Powered by the mains, it can be installed in the ceiling or on the ceiling, using the relative ACCESSORIES. The sensors feature **passive infrared technology** with shutters included, to optimize the detection area of the sensor according to different schemes.



DIMKITBT

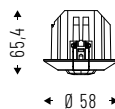

Cod.

DIMKITBT

Recessed version sensor.



DIMKITBTP

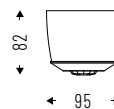

Cod.

DIMKITBTP

Ceiling version sensor.

TECHNICAL NOTES

Connection diagram.

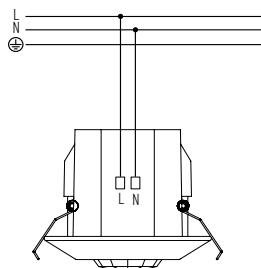

Presence/motion sensor area.

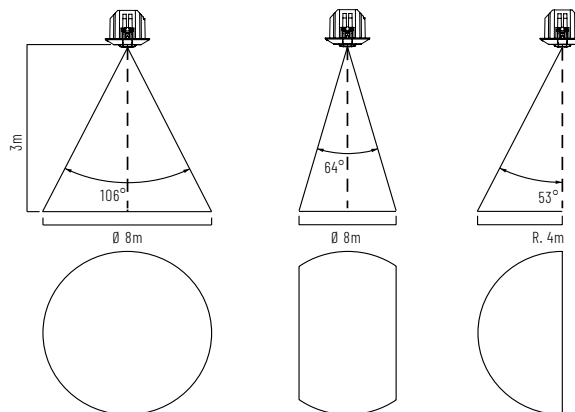

ACCESSORIES



- Wall-mounted wireless interface
- Battery powered
- Automatic wireless network
- Wireless devices remote control
- 4 Presets
- Dimmer +/-
- Color temperature control

DIMTBT

DIMKIT HCL-BT

Bluetooth® **Koolmesh**

IP 20

DIMKITHCLBT is an **intelligent sensor** that performs **PIR Detection, Daylight and automatic color temperature control** functions. With the free app, you can set latitude, date and time and call up one of the nine preset profiles for changing color temperature and brightness, depending on the context of use, or by creating a completely customized one. The master sensor controls **up to 40 DALI devices** and slave sensors. The manual Bluetooth wall controls HCLBTTD can also be integrated.



DIMKITHCLBT

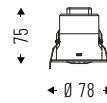

Cod.

DIMKITHCLBT

Recessed version sensor.



DIMKITHCLBTP

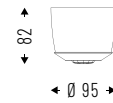

Cod.

DIMKITHCLBTP

Ceiling version sensor.

TECHNICAL NOTES

Connection diagram.

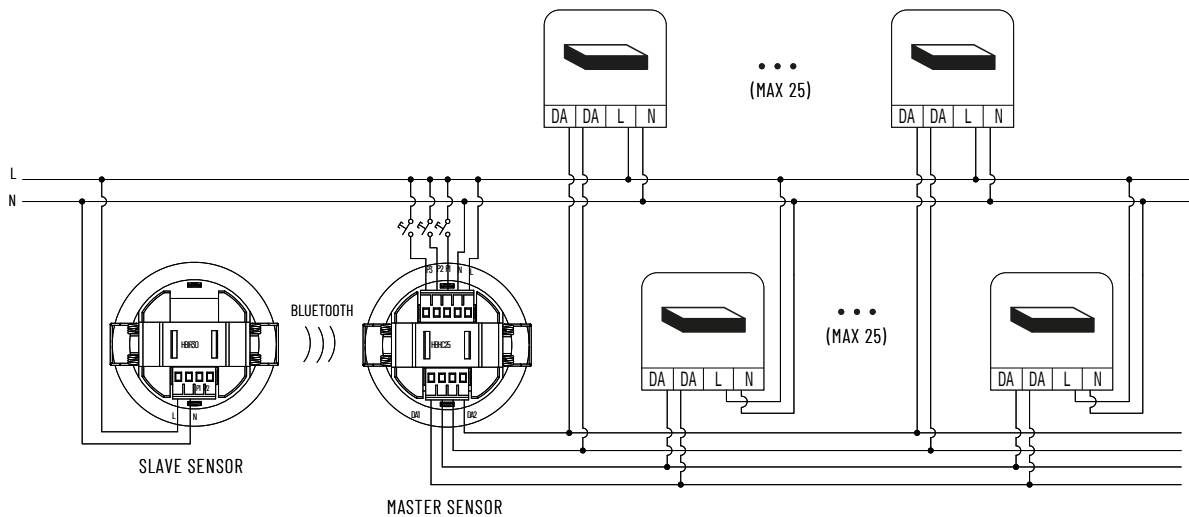

ACCESSORIES



Bluetooth touch panel for wall mount.

HCLBTTD

STAND-ALONE ELEMENTS

DALI PROTOCOL

In light management, the Digital Addressable Lighting Interface, **DALI communication protocol**, is a standard for controlling lighting equipment. For each DALI line **it is possible to control up to 64 addresses and / or 16 groups**, managed by **button interfaces and / or PIR / Daylight sensors** which, thanks to the programming of a specialized technician, allow **greater lighting comfort** in the workplace.



DIMAS

The **DIMAS** power supply is a **DALI compatible** power supply module, necessary to provide the control system with a **power supply of 250 mA**. The power supply must be mounted on a DIN rail. Status LED lights up when powered.

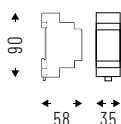

Cod.

DIMAS



DIMRM301CH

DALI overvoltage protected relay, compatible with DALI / DALI-2 protocols, with **1-channel actuator** (switch) with DALI-2 input. **Small in size**, it is suitable for panel mounting on a standard DIN rail.

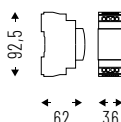

Cod.

DIMRM301CH





DIMXC

DALI pushbutton interface with **4 independent inputs** for potential-free contacts. Designed for the **connection of momentary action switches or push-buttons**. Operating mode and flow rate **adjustable by means of 2 rotary selectors**. 250mm cables included.

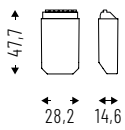

Cod.

DIMXC



SENSDR

Recessed multi sensor for small and medium-sized areas. **PIR motion detection** with ambient light control is powered via **DALI Bus**. Individual adjustment of parameters with **software configuration**.

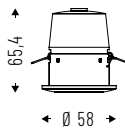

Cod.

SENSDR



SENSDP

Ceiling mounted multi sensor for small and medium-sized areas. **PIR motion detection** with ambient light control is powered via **DALI Bus**. Individual adjustment of parameters with **software configuration**.

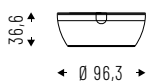

Cod.

SENSDP



STAND-ALONE ELEMENTS

DALI-2 PROTOCOL

The **DALI-2 standard is the evolution of the DALI protocol**, with the advantage of **total compatibility** with the previous version. It is possible to use DALI-2 drivers in lighting systems with DALI standards, just as it is possible to use DALI-2 modules or sensors combined with DALI drivers with the **addition of new functions and applications for emergency lighting and color management**.



DIMAS3

DALI-2 compatible power module, necessary to provide the control system with a **70mA power supply**. The excellent scalability allows you to connect up to two DIMAS3 in each DALI-2 installation. The **compact dimensions** allow integration both in switchboard and in 503 box.

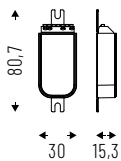

Cod.

DIMAS3



DIMRM301CH

DALI overvoltage protected relay, compatible with DALI / DALI-2 protocols, with **1-channel actuator** (switch) with DALI-2 input. **Small in size**, it is suitable for panel mounting on a standard DIN rail.

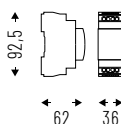

Cod.

DIMRM301CH





DIMXC2

DALI-2 pushbutton interface with 4 independent inputs for potential-free contacts. Designed for connecting standard momentary action switches or push buttons. **Compatible with all DALI-2 certified Application Controllers** for lighting control (not compatible with the DIMKIT-13 system). 250mm cables included.

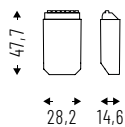

Cod.

DIMXC2



SENSD2R

Recessed multi sensor for small and medium-sized areas. **PIR motion detection** with ambient light control is powered via **DALI-2 Bus**. Individual adjustment of parameters with **software configuration**.

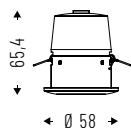

Cod.

SENSD2R



SENSD2P

Ceiling mounted multi sensor for small and medium-sized areas. **PIR motion detection** with ambient light control is powered via **DALI-2 Bus**. Individual adjustment of parameters with **software configuration**.

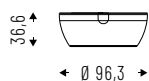

Cod.

SENSD2P



STAND-ALONE ELEMENTS

BLUETOOTH CASAMBI PROTOCOL

The Bluetooth - Casambi protocol **allows to manage fixtures on the network through remote control** from a dedicated App **or through wireless sensors**. The network can contain multiple nodes: each node can communicate with another within the **Bluetooth coverage area, up to a maximum distance of 50 m**. The safety of the system is guaranteed by encrypted protocols between individual Casambi units. All requests between devices are based on the user's network privileges and are uniquely authenticated.



DIMINW4CBT

Interface capable of **converting the Wireless-Casambi DALI or 1-10V signal**. Manages **up to 40 devices** on 4 channels in broadcast mode and communicates with DALI DT6 devices.

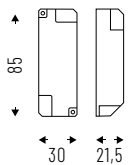

Cod.

DIMINW4CBT





esse-ci



ESSE-CI Srl

Viale del Lavoro 25 | 35010 | Vigonza | Padova | Italy
(+39) 049 89.59.511 | info@esse-ci.it | esse-ci.com



esse-ci



ESSE-CI Srl

Viale del Lavoro 25 | 35010 | Vigonza | Padova | Italy
(+39) 049 89.59.511 | info@esse-ci.it | esse-ci.com





2
0
2
3

